



US00D393692S

# United States Patent [19] Ko

[11] Patent Number: Des. 393,692

[45] Date of Patent: \*\*Apr. 21, 1998

[54] FAUCET

[75] Inventor: Hsi-Chia Ko, Changhua Hsien, Taiwan

[73] Assignee: Chung Cheng Faucet Co., Ltd.,  
Changhua Hsien, Taiwan

[\*\*] Term: 14 Years

[21] Appl. No.: 69,766

[22] Filed: Apr. 23, 1997

[51] LOC (6) Cl. .... 23-01

[52] U.S. Cl. .... D23/238

[58] Field of Search ..... D23/238-243,  
D23/250-257; 4/675-678; 137/801; 16/110 R,  
118, 121, 123, 125

[56] **References Cited**

**U.S. PATENT DOCUMENTS**

- D. 144,249 3/1946 Hinderer ..... D23/243
- D. 193,924 10/1962 Harty ..... D23/241
- D. 258,519 3/1981 Thenenot ..... D23/243

D. 279,923 7/1985 Niemann et al. .... D23/243

*Primary Examiner*—Stella Reid  
*Assistant Examiner*—Eric Watterson  
*Attorney, Agent, or Firm*—Browdy and Neimark

[57] **CLAIM**

The ornamental design for a "faucet", as shown and described.

**DESCRIPTION**

FIG. 1 is a perspective view of a faucet showing my new design;  
FIG. 2 is a front view thereof;  
FIG. 3 is a rear view thereof;  
FIG. 4 is a left side view thereof, the right side view is identical;  
FIG. 5 is a top view thereof; and,  
FIG. 6 is a bottom view thereof.  
The broken line showing of the faucet handles are for illustrative purposes only and forms no part of the claimed design.

**1 Claim, 4 Drawing Sheets**

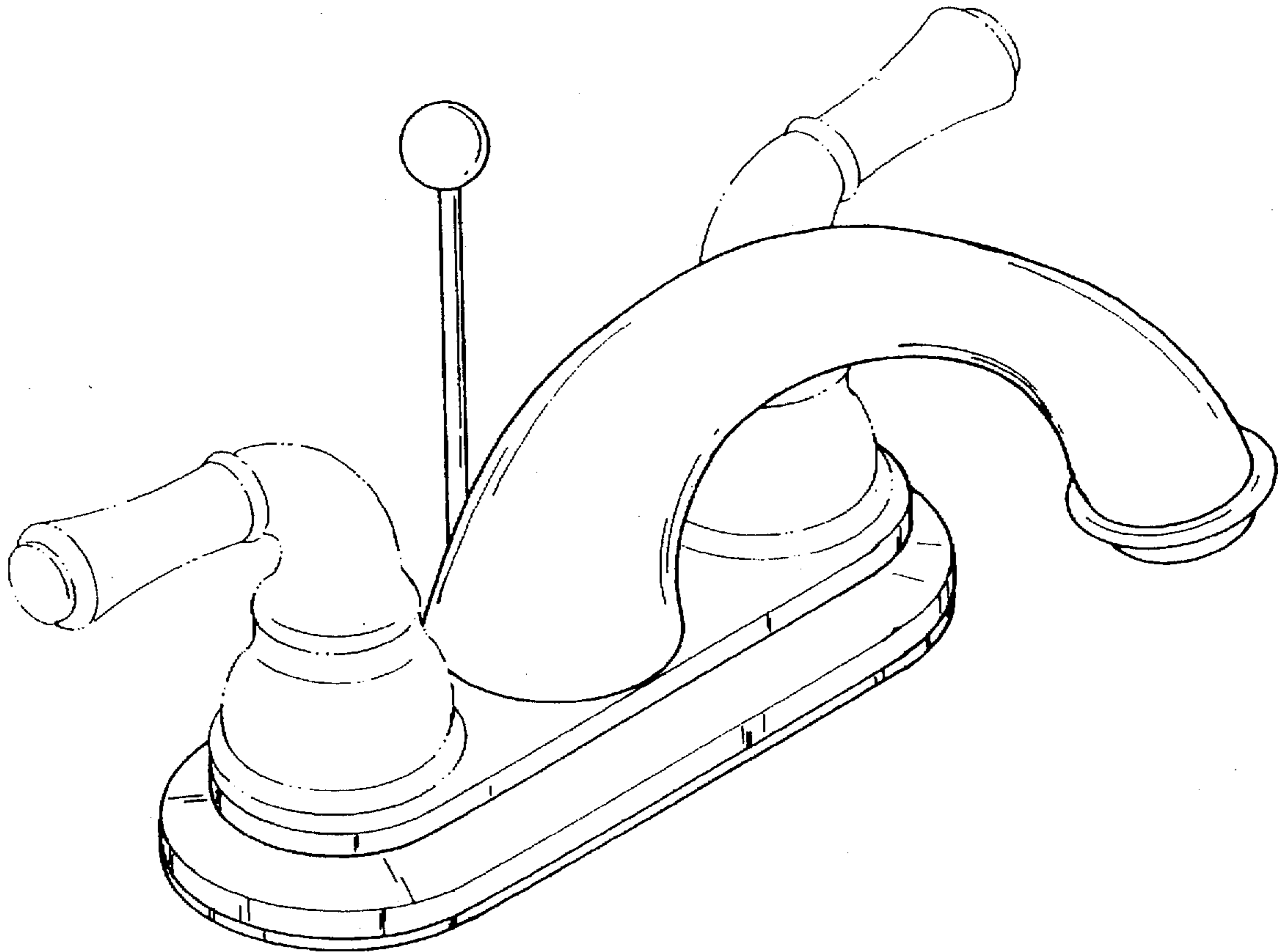

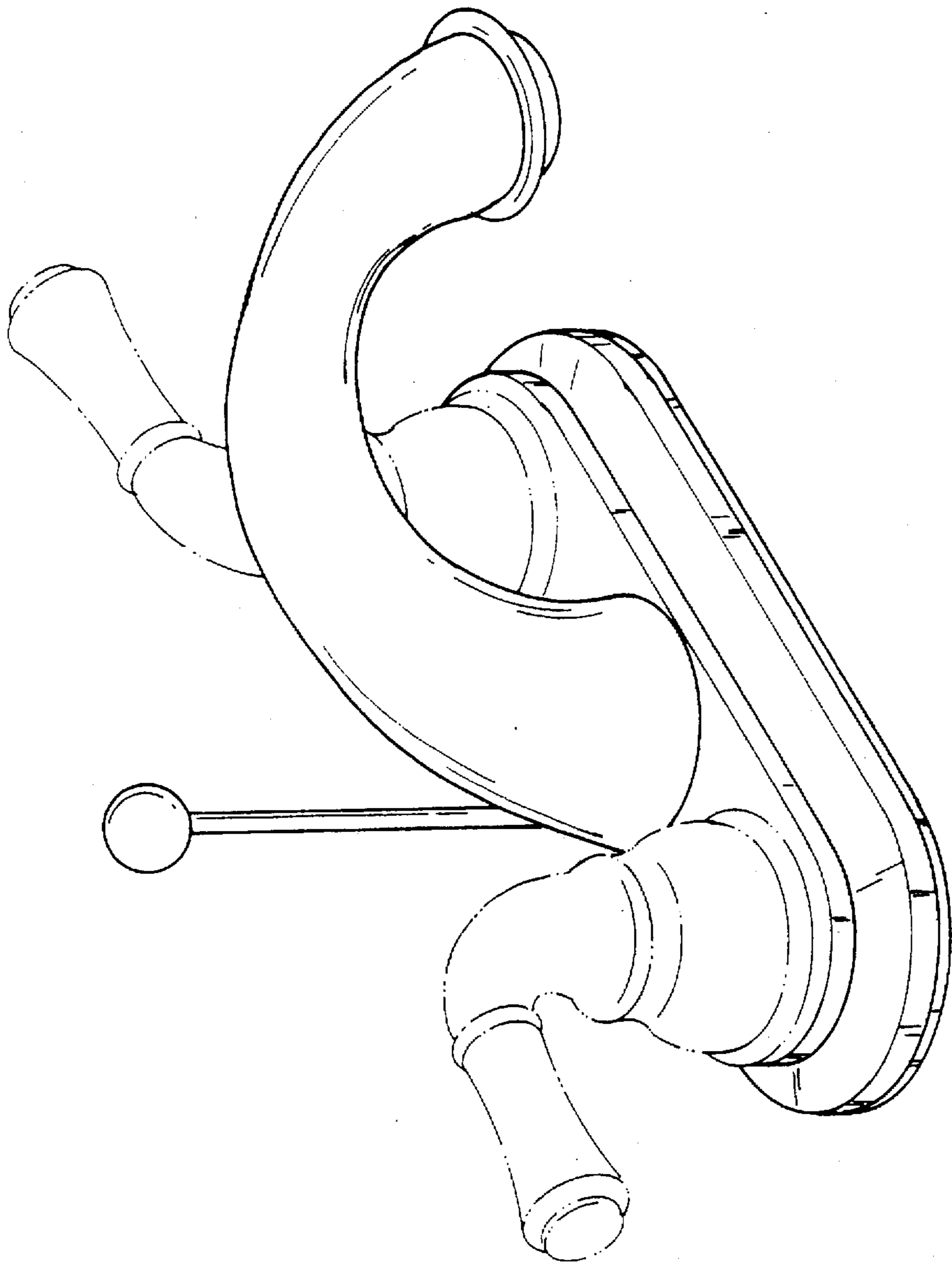

FIG. 1

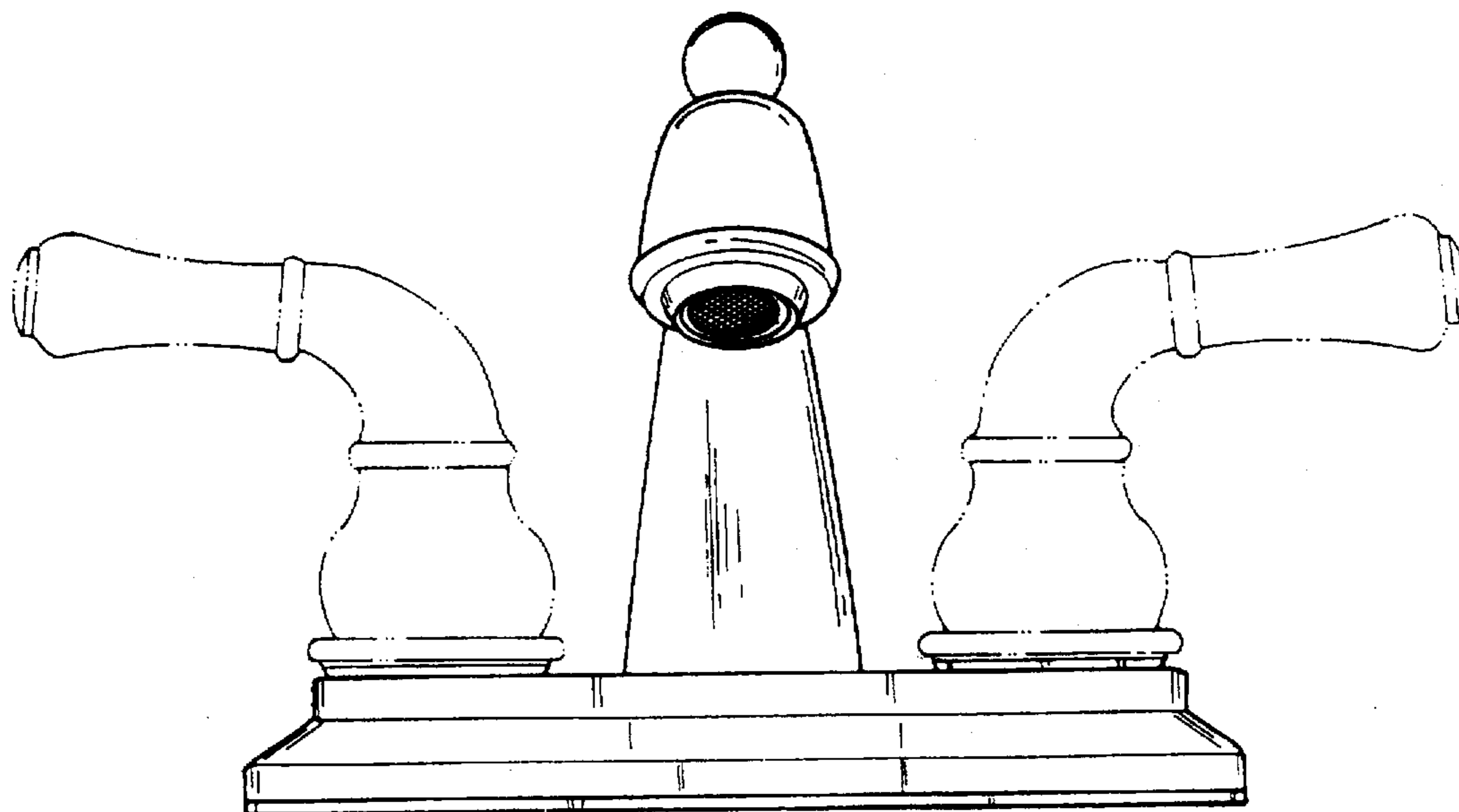

FIG. 2

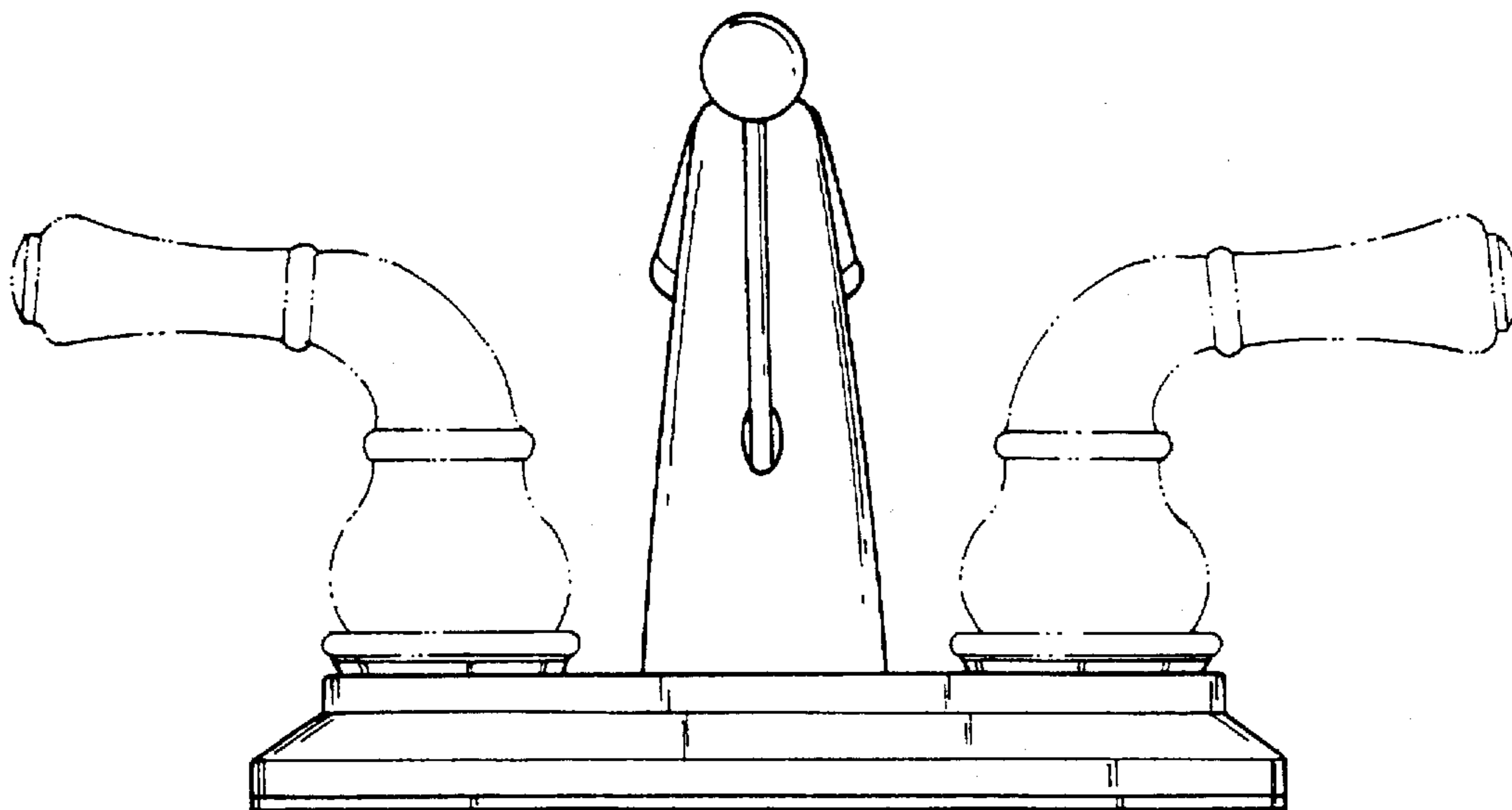

FIG. 3

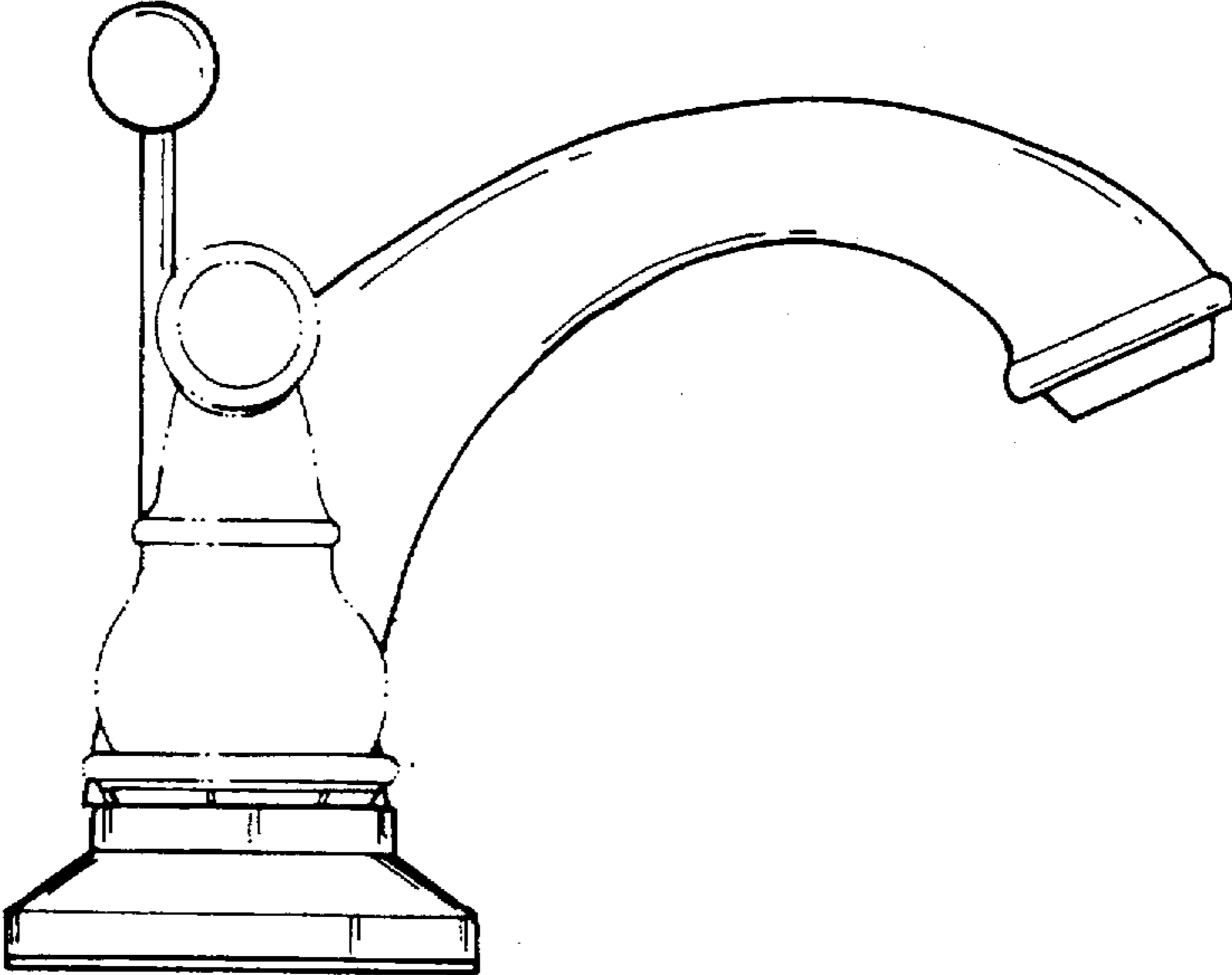

FIG. 4

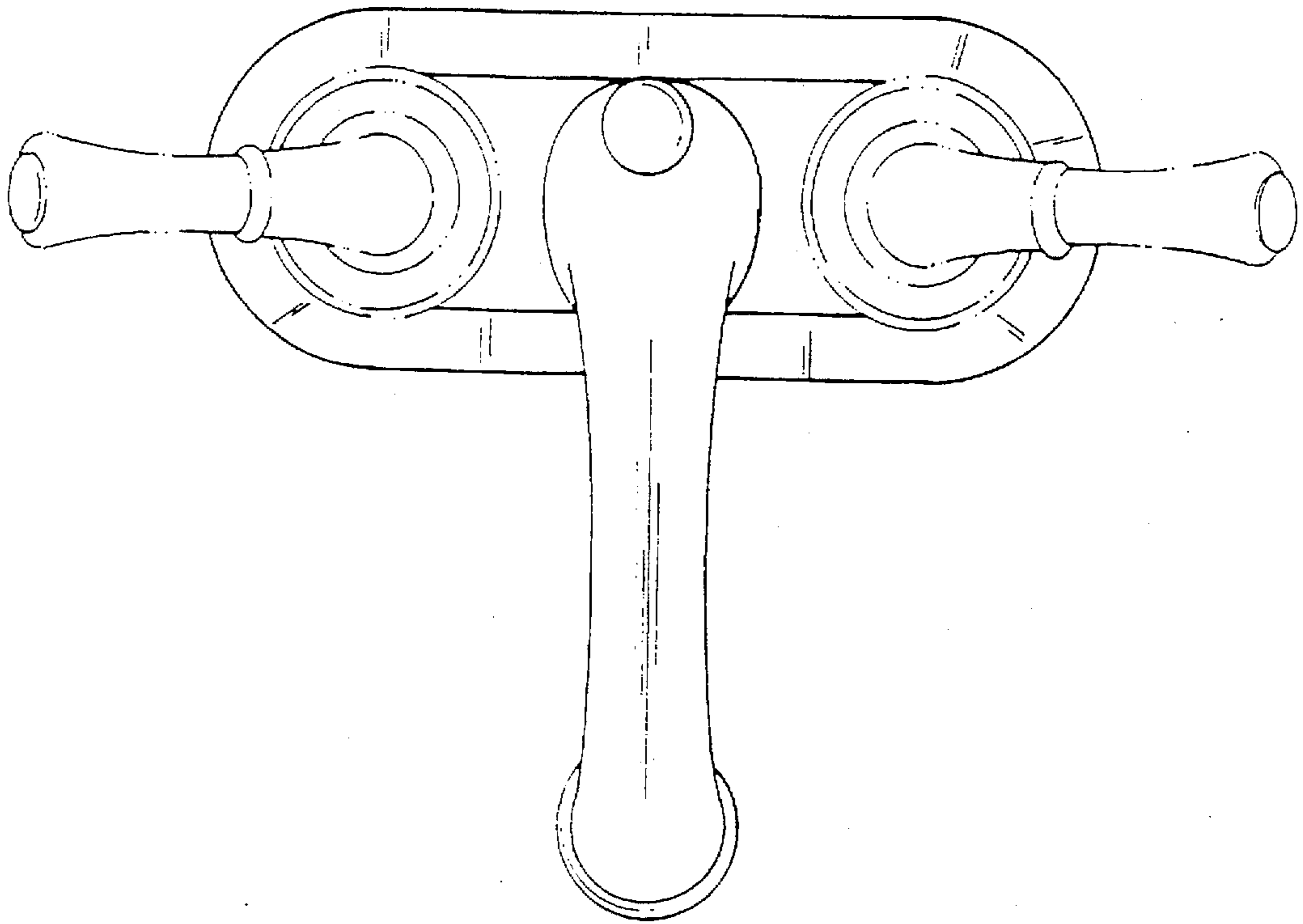

FIG. 5

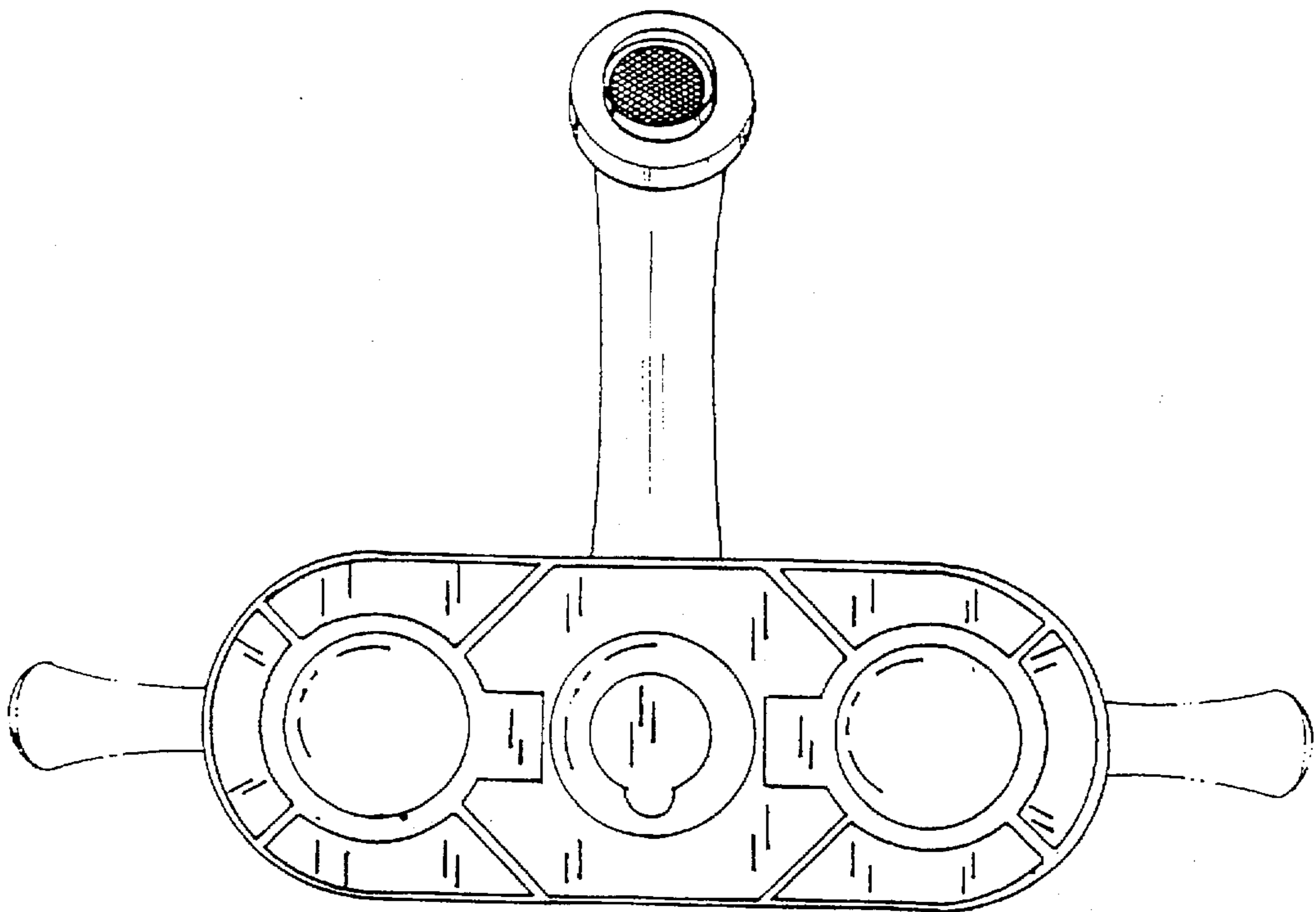

FIG. 6