



US00D393550S

# United States Patent [19] Jay

[11] Patent Number: **Des. 393,550**  
[45] Date of Patent: **\*\*Apr. 21, 1998**

[54] **OUTDOOR BEVERAGE DISPLAY STAND**

2,555,644 6/1951 Heer ..... 312/290 X  
3,316,048 4/1967 Levy ..... 312/100 X  
5,678,693 10/1997 Tapp et al. .... 312/290 X

[75] Inventor: **Richard Jay**, Westport, Conn.

[73] Assignee: **Display Technologies, Inc.**, Whitestone, N.Y.

*Primary Examiner*—James Gandy  
*Assistant Examiner*—Linda Brooks  
*Attorney, Agent, or Firm*—Amster, Rothstein & Ebenstein

[\*\*] Term: **14 Years**

[57] **CLAIM**

[21] Appl. No.: **63,132**

The ornamental design for an outdoor beverage display stand, as shown and described.

[22] Filed: **Nov. 27, 1996**

**DESCRIPTION**

[51] **LOC (6) CL.** ..... **06-04**

[52] **U.S. Cl.** ..... **D6/434**

[58] **Field of Search** ..... D6/396, 397, 449, D6/440, 450, 432, 436, 434; 229/108, 116.4; D34/1, 7; D25/16, 17, 33; D21/114-116; 312/309, 310, 315, 316, 204, 257.1, 211, 212, 283, 290, 326; 52/72, 90.1, 79.1, 91.1; 446/82, 83, 84, 476, 478, 487, 488; 206/822, 457; D9/322; D3/271; D30/126, 112; 220/908

FIG. 1 is an isometric view from the front, top and one side of an outdoor beverage display stand showing my new design;

FIG. 2 is an isometric view thereof from the back, top and the one side;

FIG. 3 is a top plan view thereof;

FIG. 4 is a bottom plan view thereof;

FIG. 5 is a side elevation view thereof from the one side, the other side being a mirror image thereof;

FIG. 6 is a view similar to FIG. 1, but showing the display in a position of use, with the doors open and the roof pivoted upwardly; and,

FIG. 7 is a view similar to FIG. 6, but showing the display with the upstanding front bottom panel shown in FIG. 6 removed to reveal details of internal construction.

The feet, surface indicia, and environmental structure shown in broken lines in FIGS. 1, 2, 3, 4, 5, 6, and 7 are for illustrative purposes only and form no part of the claimed design.

[56] **References Cited**

**U.S. PATENT DOCUMENTS**

D. 241,099	8/1976	Davis	.....	D6/434
D. 267,531	1/1983	Lenger, Jr.	.....	D6/434
D. 298,891	12/1988	Jackle et al.	.....	D6/450
D. 308,434	6/1990	Deweese et al.	.....	D6/432 X
D. 332,332	1/1993	Markey	.....	D34/7 X
D. 370,343	6/1996	Kraner	.....	D3/271
D. 383,177	9/1997	Darneille	.....	D21/114
2,086,832	7/1937	Vincent	.....	312/290 X
2,531,444	11/1950	Lane	.....	312/290 X

**1 Claim, 5 Drawing Sheets**

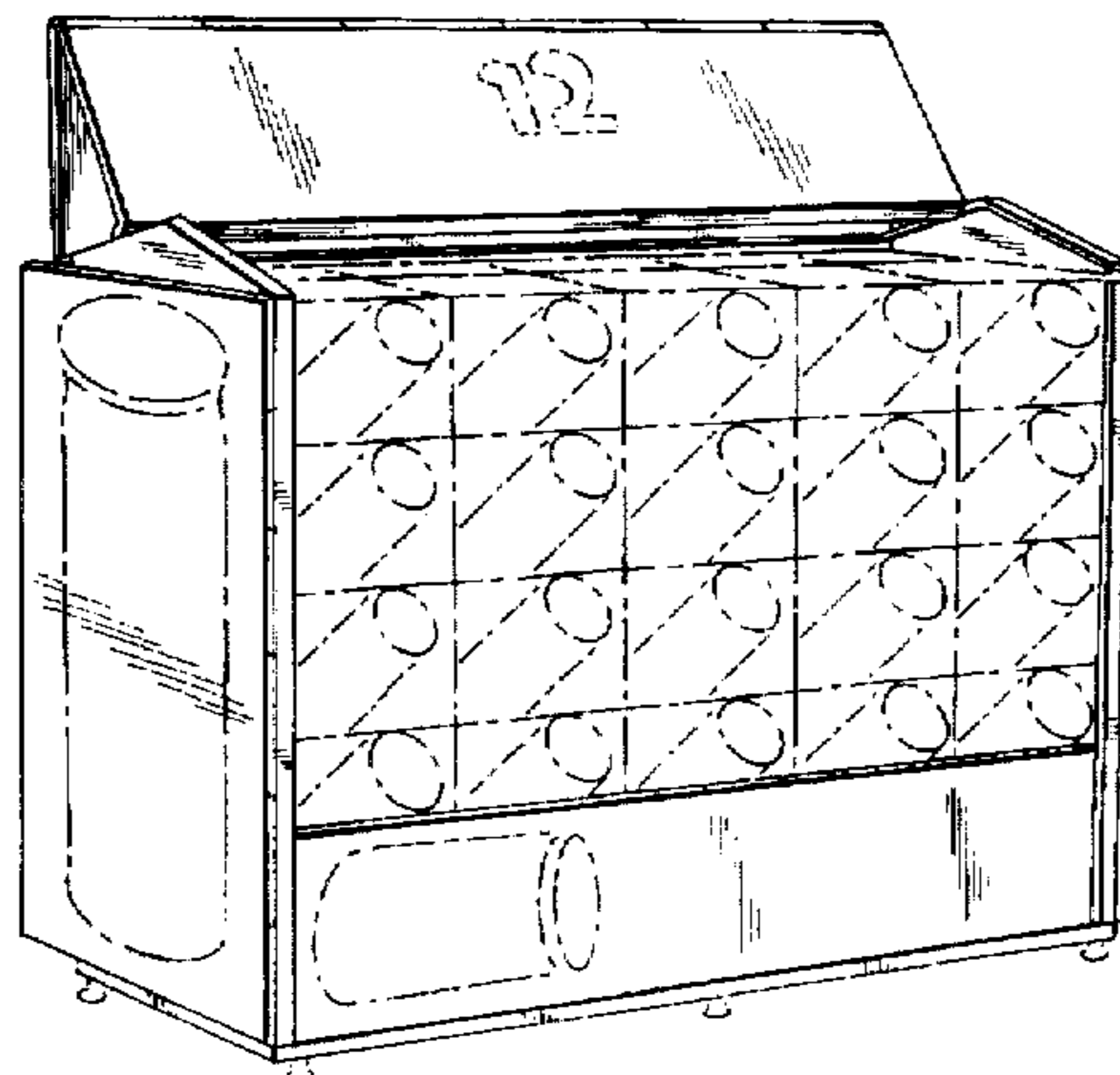
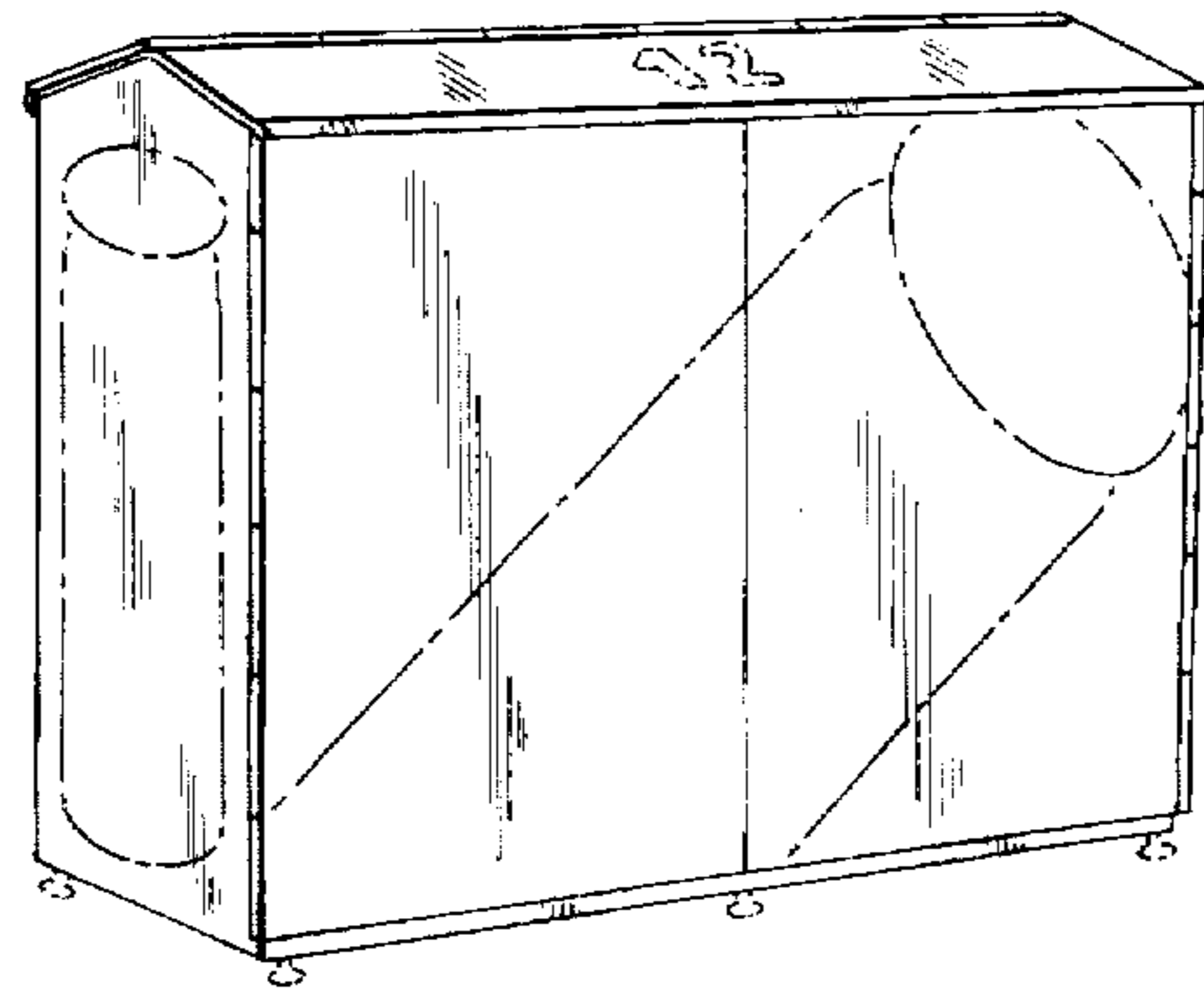

FIG. 1

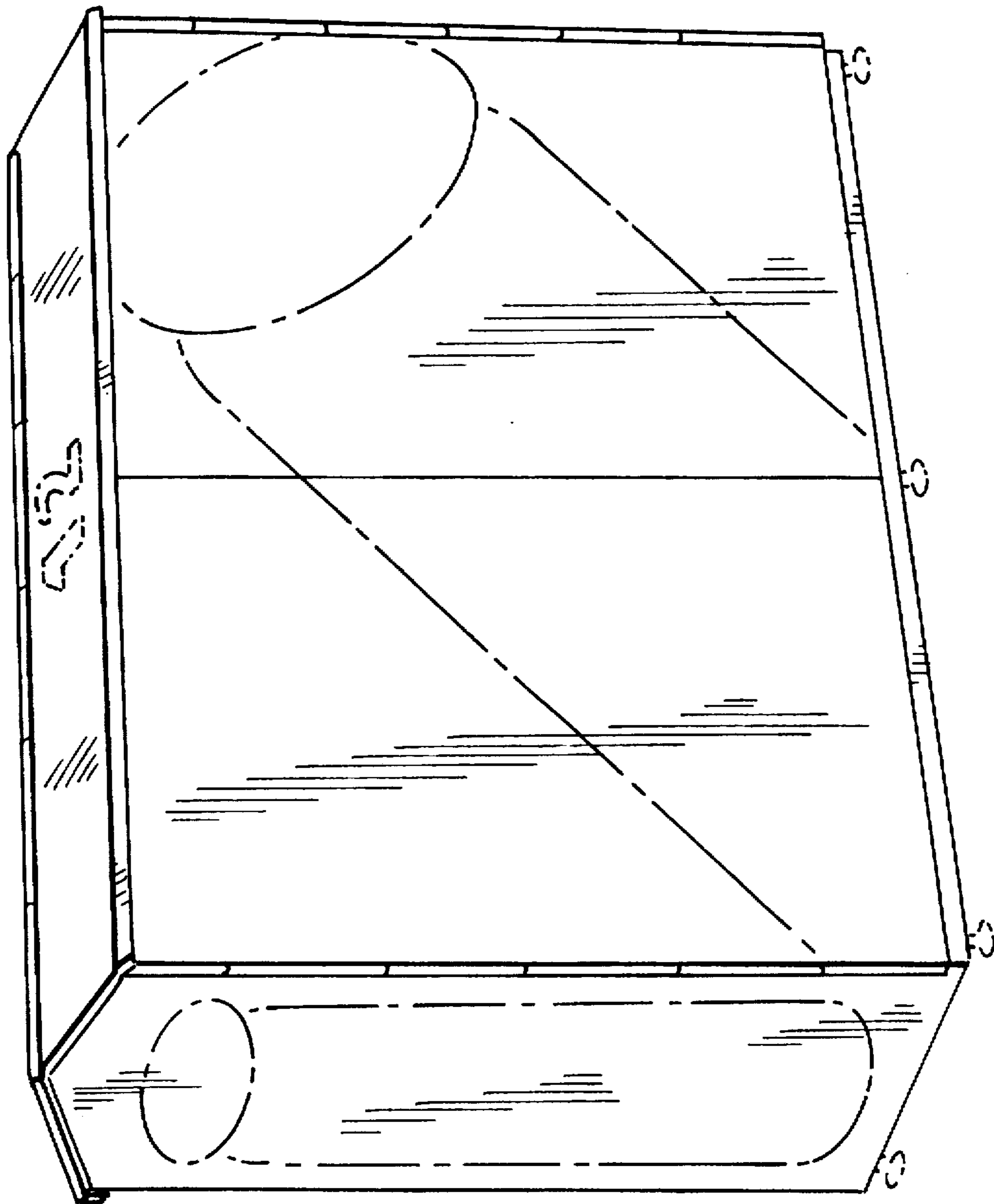

FIG. 2

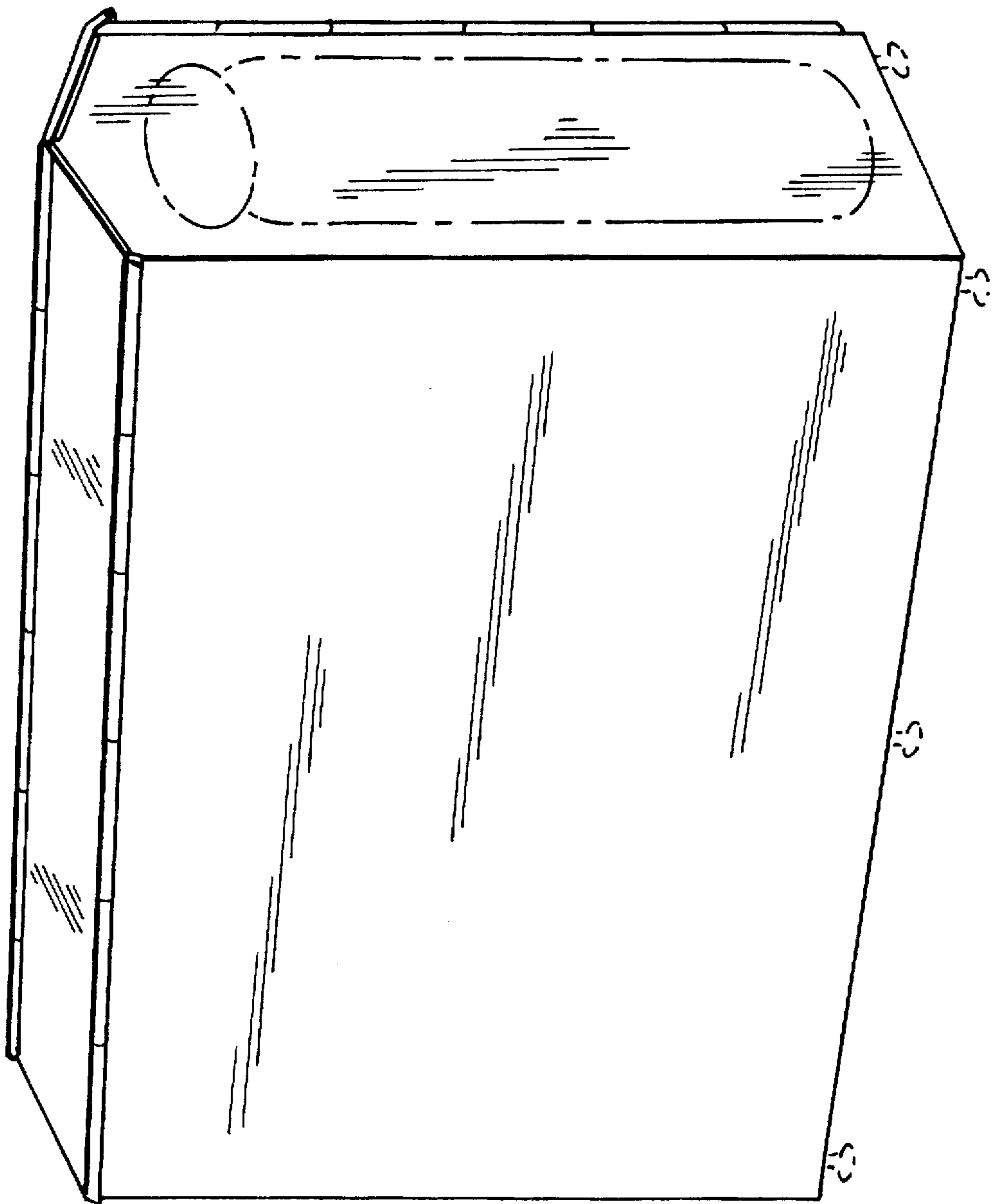

FIG. 3

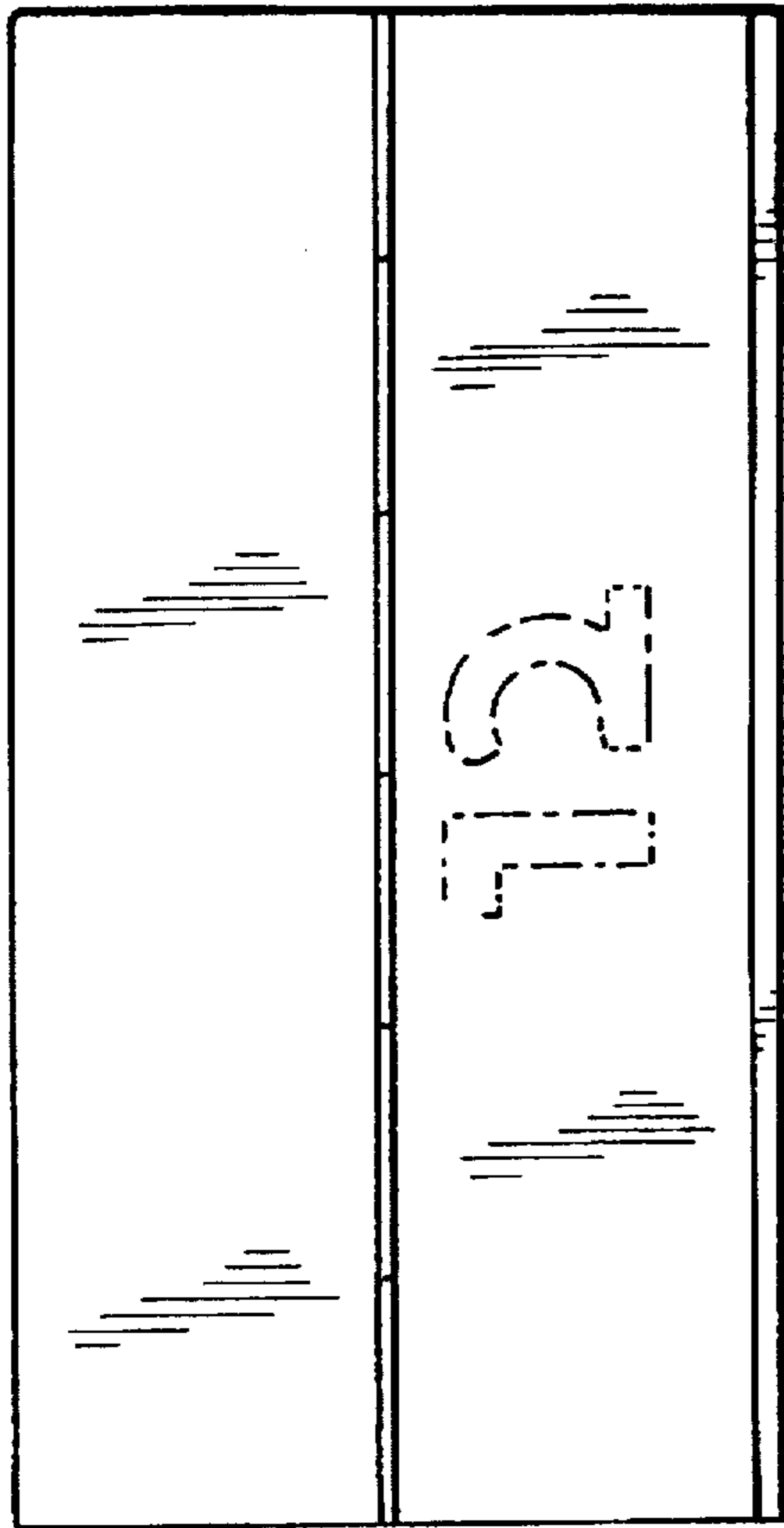

FIG. 5

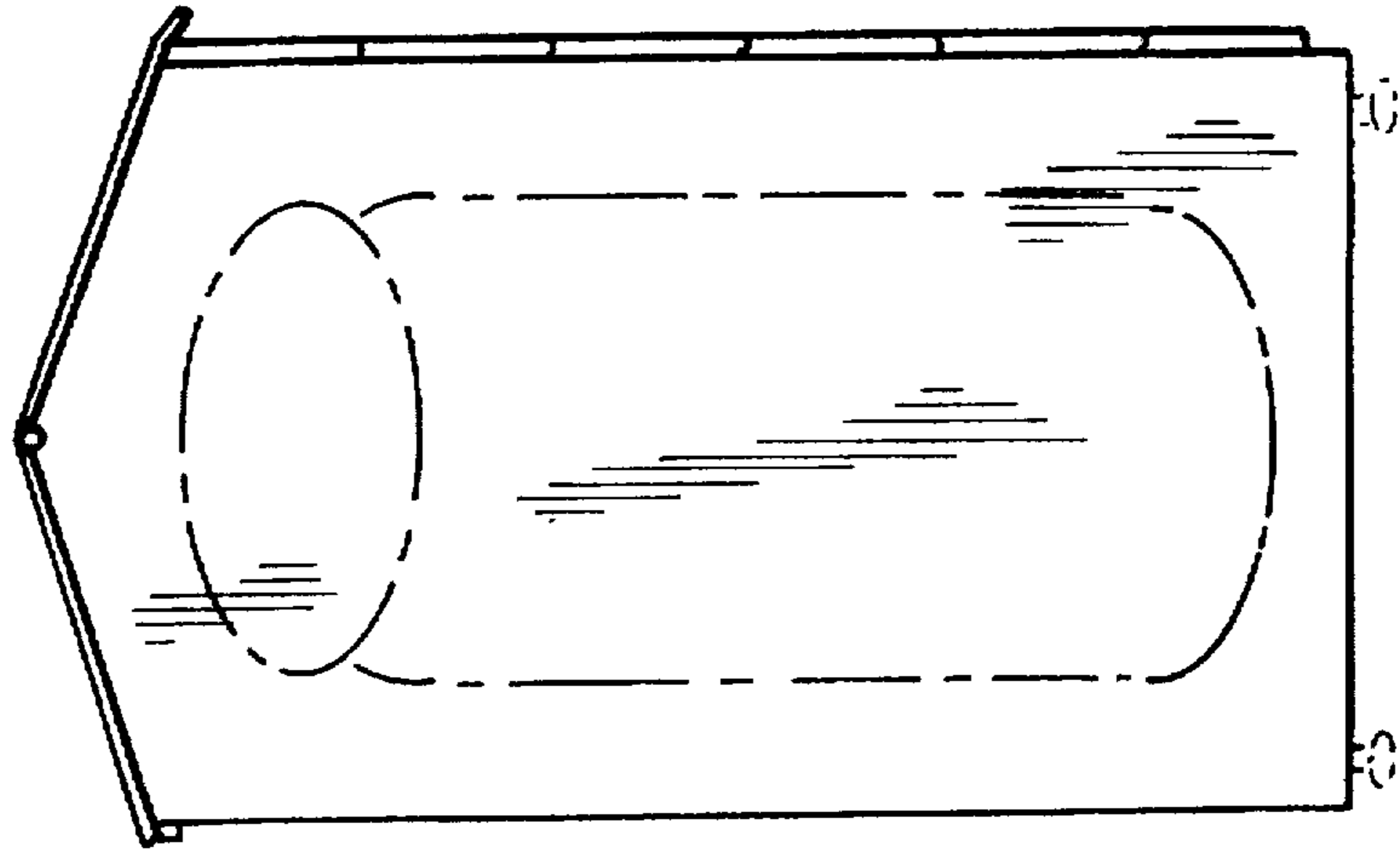

FIG. 4

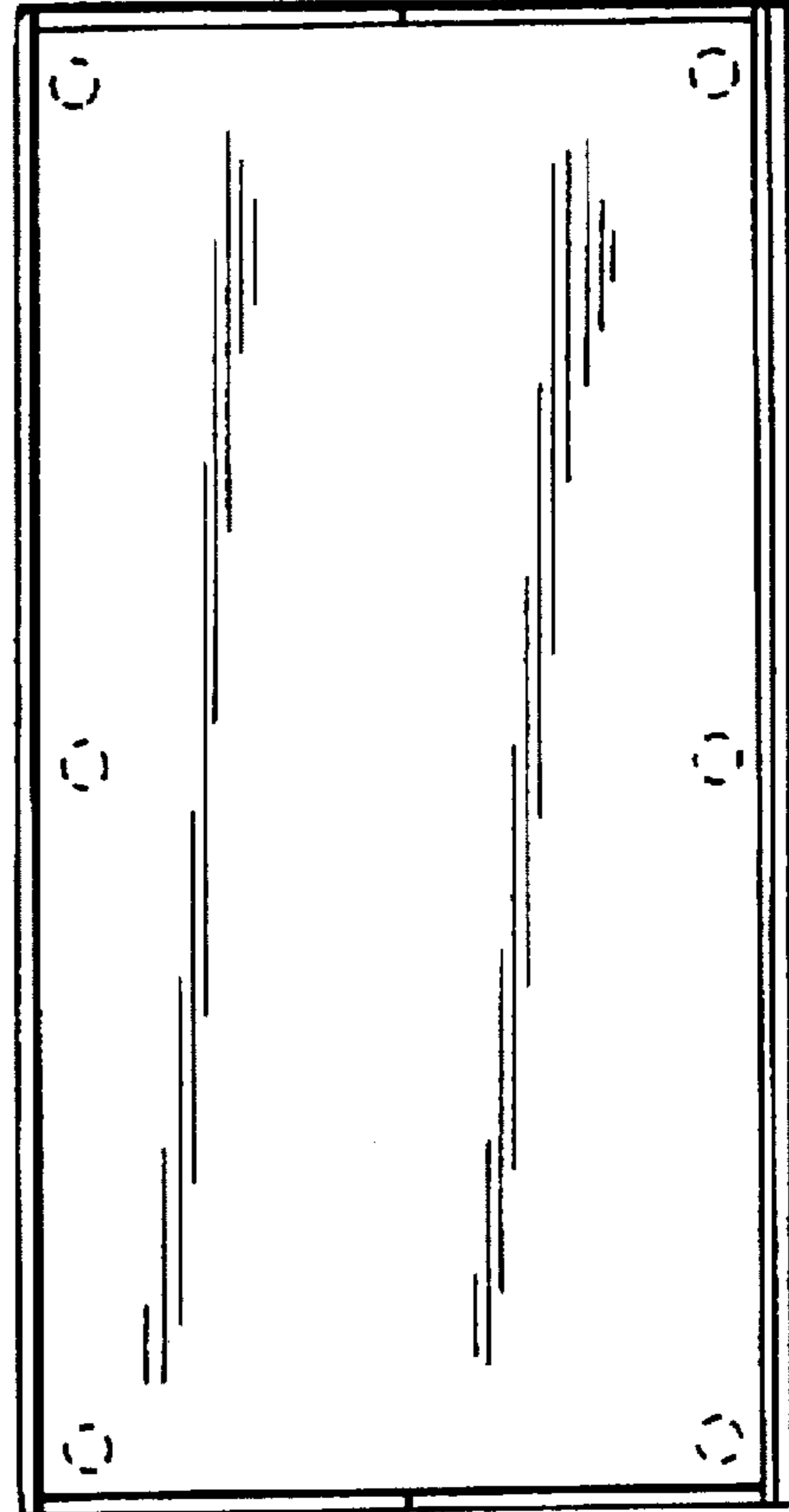

FIG. 6

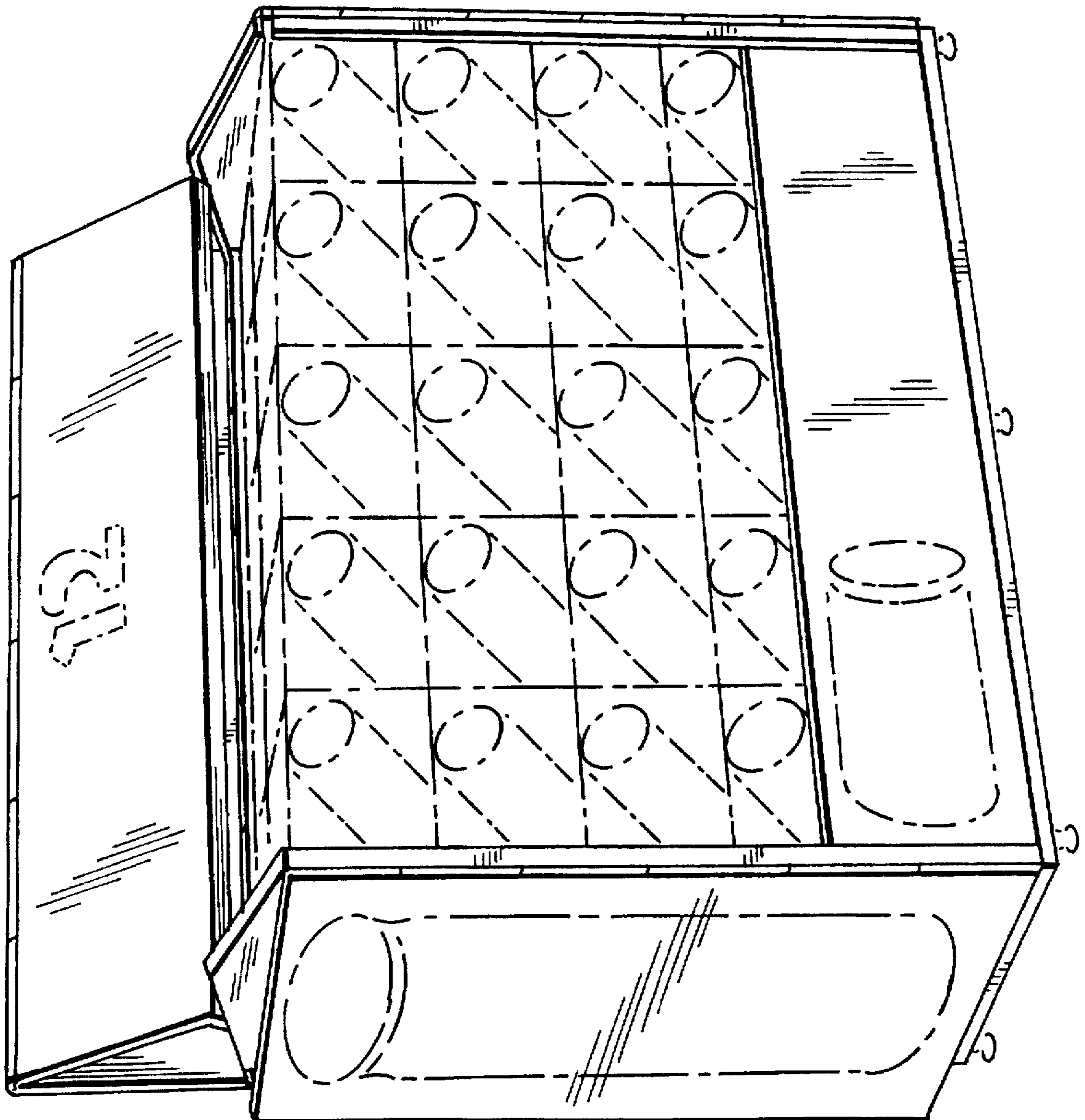

FIG. 7

