



US00D393542S

United States Patent [19]

Thompson

[11] Patent Number: **Des. 393,542**

[45] Date of Patent: ****Apr. 21, 1998**

[54] **JEWELRY ACCESSORY CABINET**
[76] Inventor: **La Verne Thompson, 4407 Francis Ave. #103, Los Angeles, Calif. 90005**

[**] Term: **14 Years**

[21] Appl. No.: **27,254**

[22] Filed: **Aug. 16, 1994**

[51] LOC (6) Cl. **03-01**

[52] U.S. Cl. **D3/294; D3/295; D3/903**

[58] Field of Search **D3/294, 295, 903; 206/315.1, 564, 565, 472; 312/245, 204**

[56] References Cited

U.S. PATENT DOCUMENTS

D. 186,829	12/1959	Jachetta	D3/903
D. 266,115	9/1982	Glenn, Sr. et al.	D3/295
D. 317,380	6/1991	Snyder	D3/295
D. 319,155	8/1991	Powell	D3/903
D. 348,155	6/1994	McCreary et al.	D3/295

4,058,356	11/1977	Michal	D3/903
4,324,446	4/1982	LeSage	206/566
4,420,084	12/1983	Whelan	206/566
4,799,587	1/1989	Desanto	206/472
5,141,300	8/1992	Ciesla	206/566

Primary Examiner—Philip S. Hyder

[57] CLAIM

The ornamental design for a jewelry accessory cabinet, as shown and described.

DESCRIPTION

FIG. 1 is a front perspective view of a jewelry accessory cabinet, showing my new design, in an open position; FIG. 2 is a front perspective view thereof, in a closed position; FIG. 3 is a rear perspective view thereof, in an open position; FIG. 4 is a front perspective view thereof, in an open position with one of the panels detached; and, FIG. 5 is a bottom plan view thereof.

1 Claim, 4 Drawing Sheets

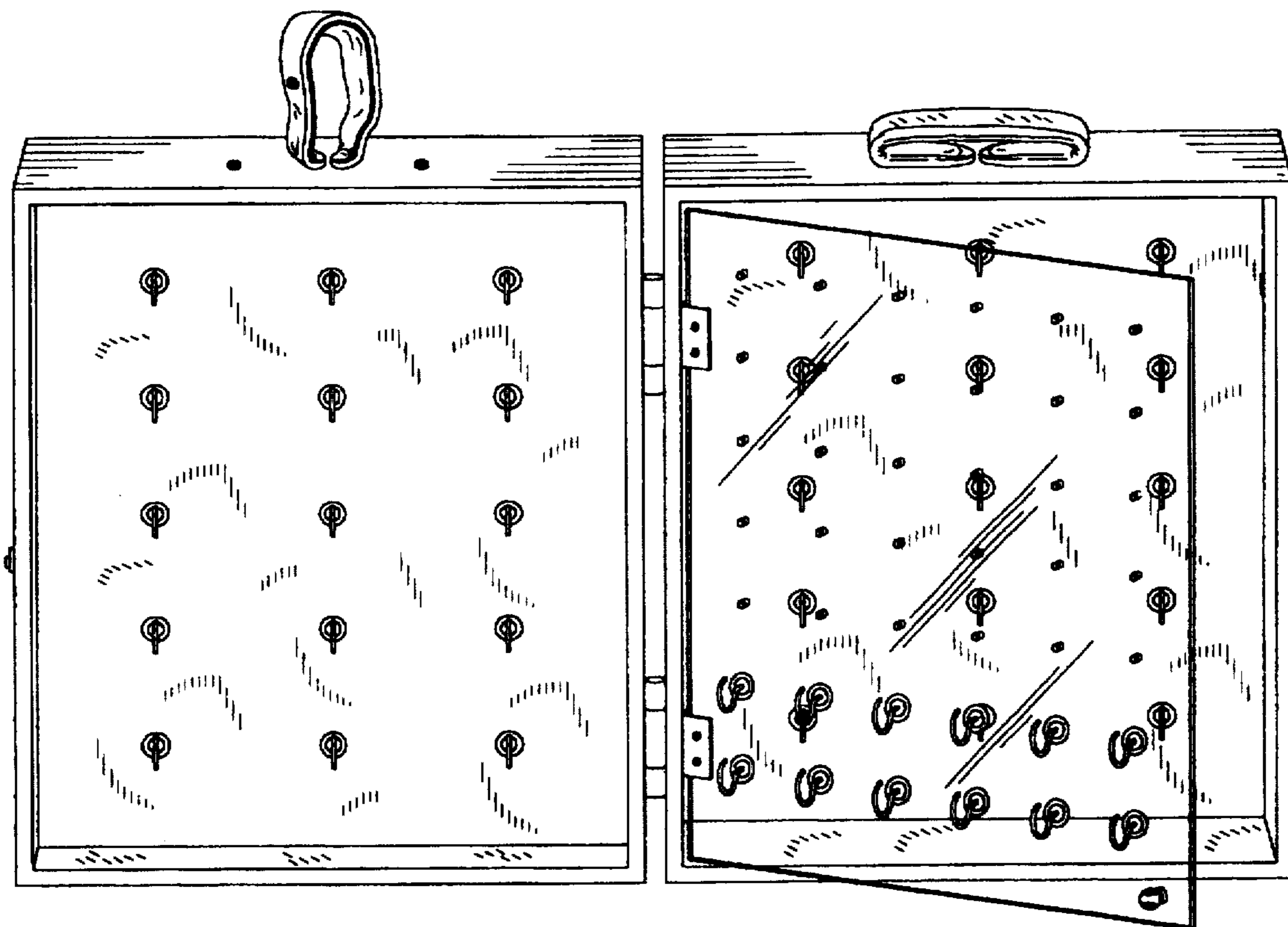

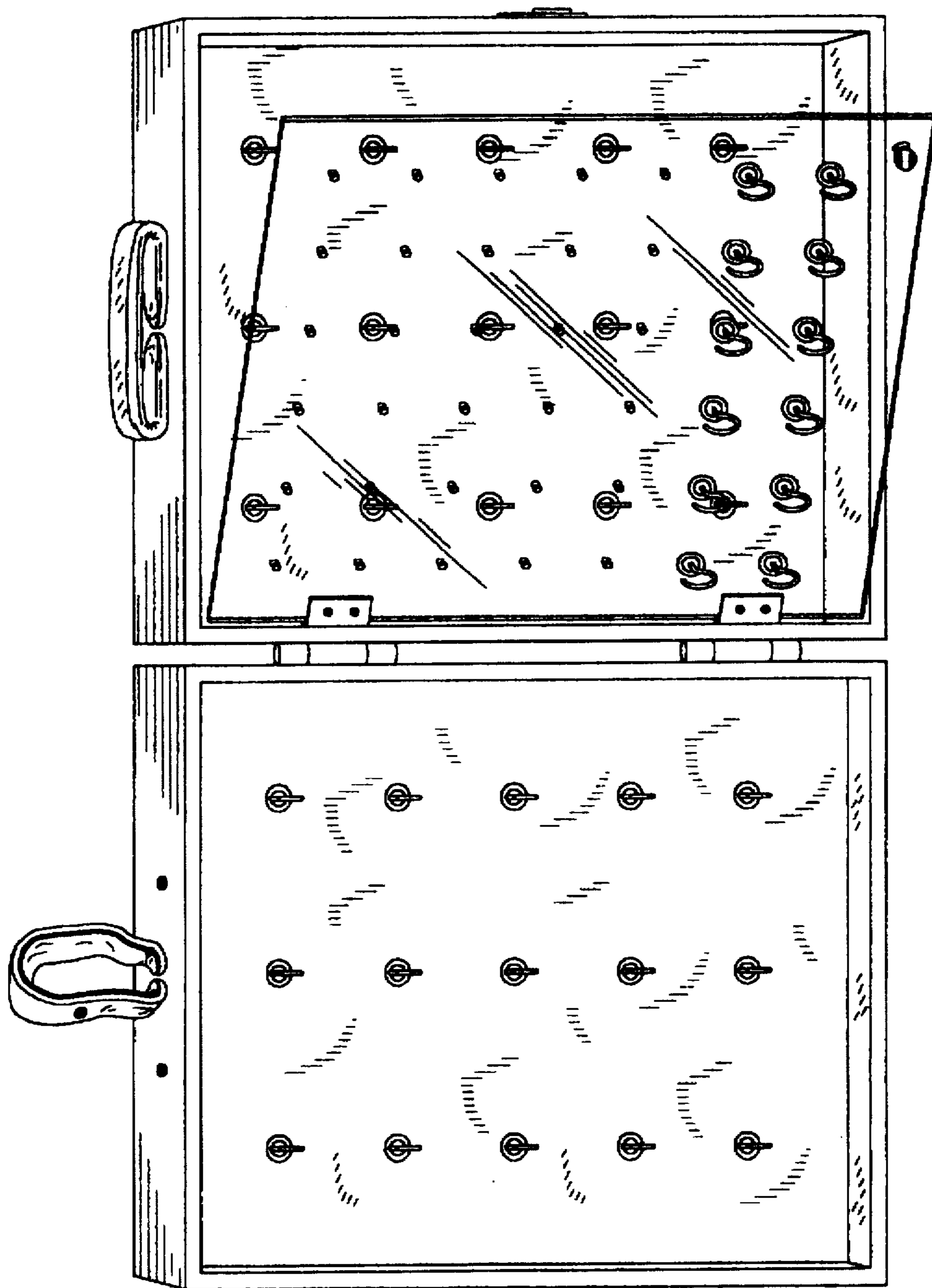

FIG. 1

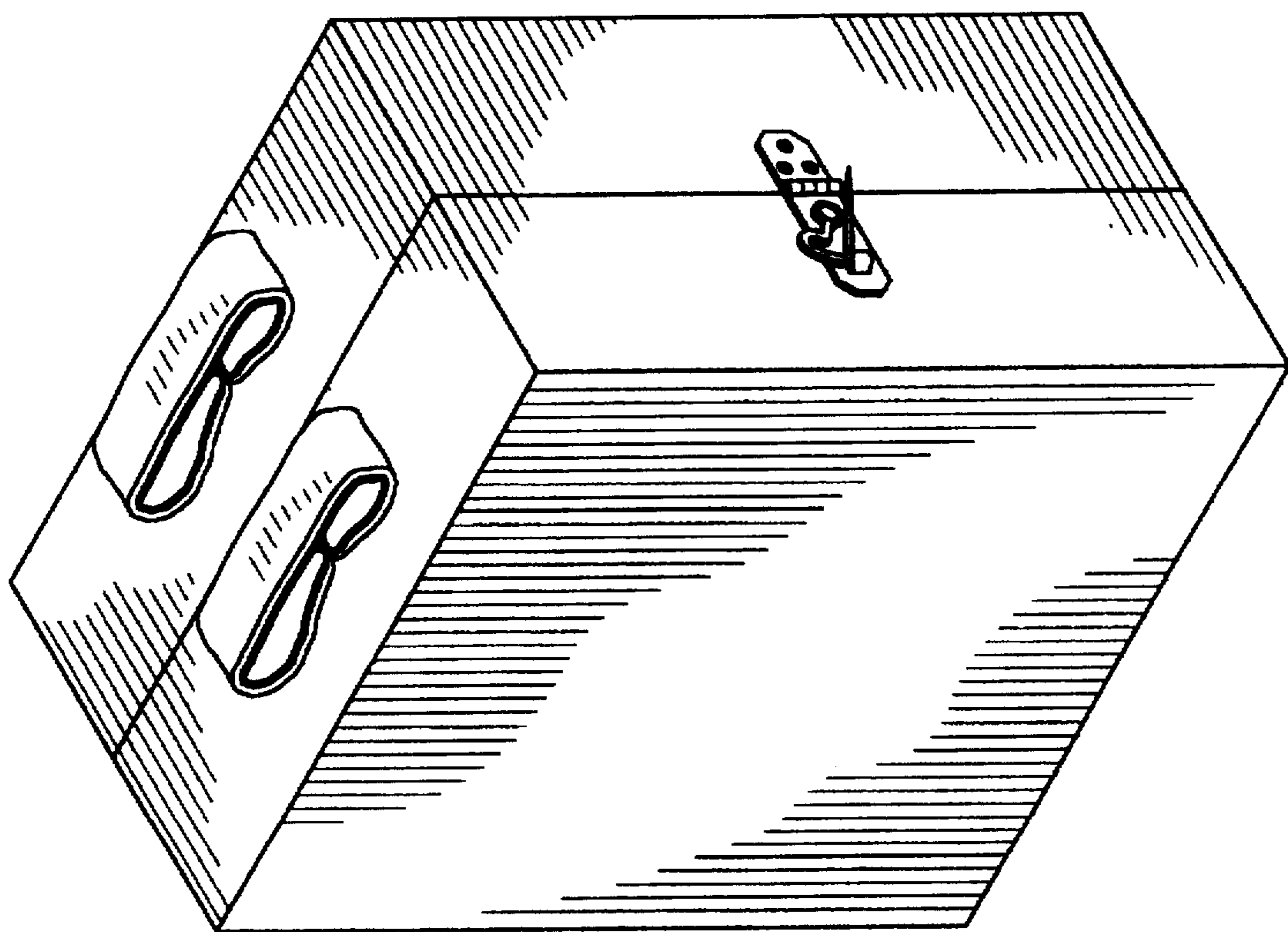

FIG. 2

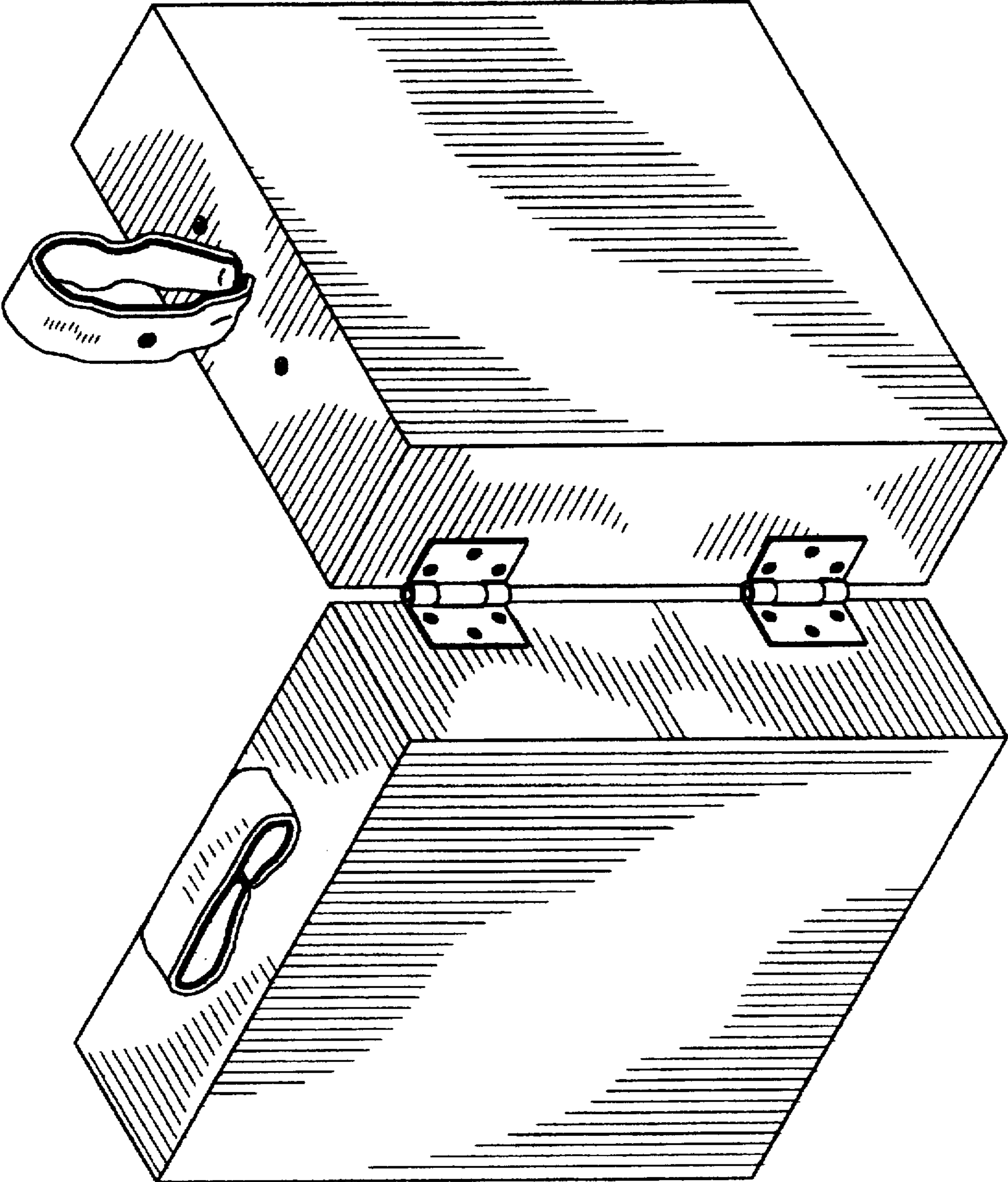

FIG. 3

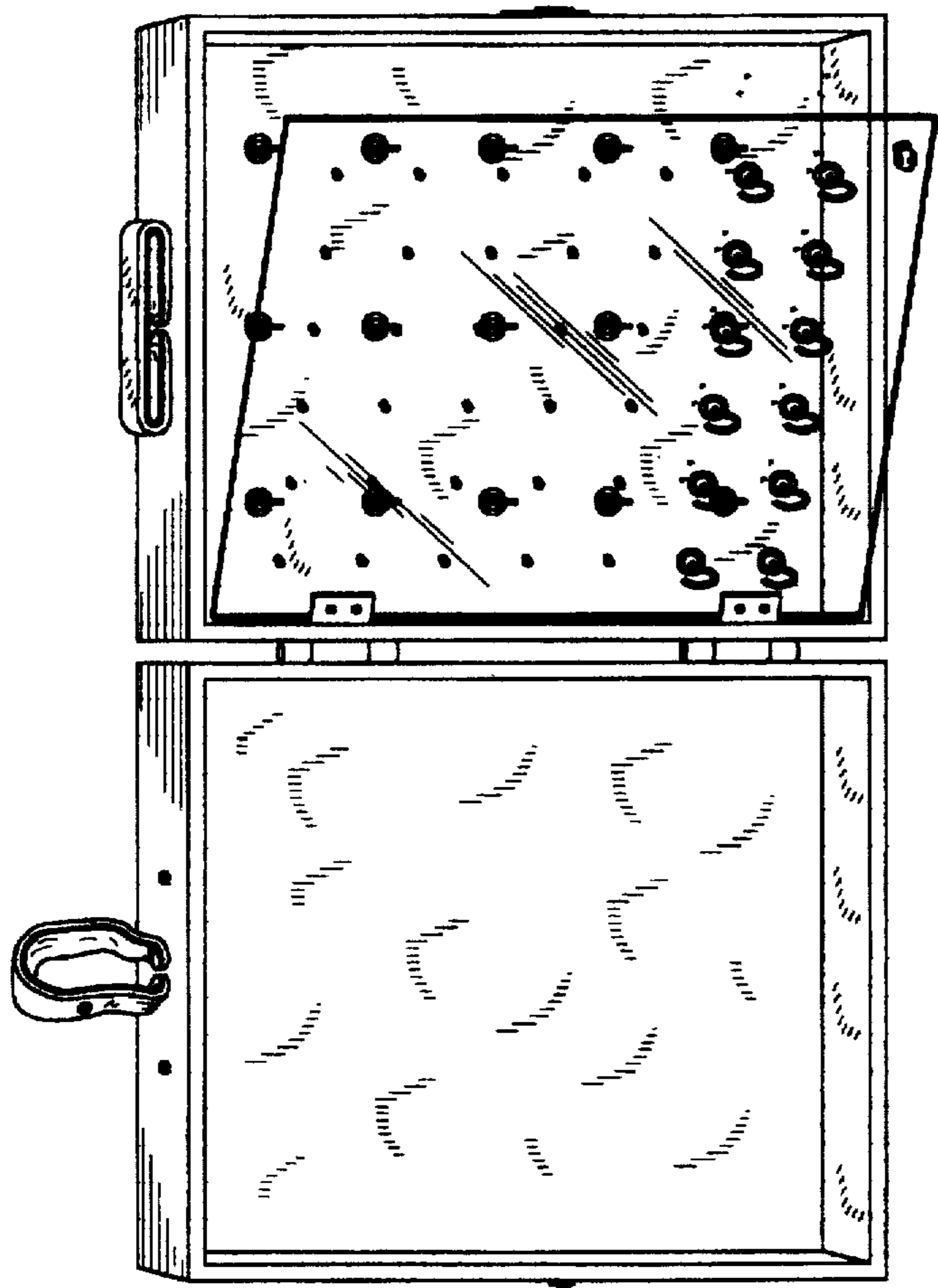

FIG. 4

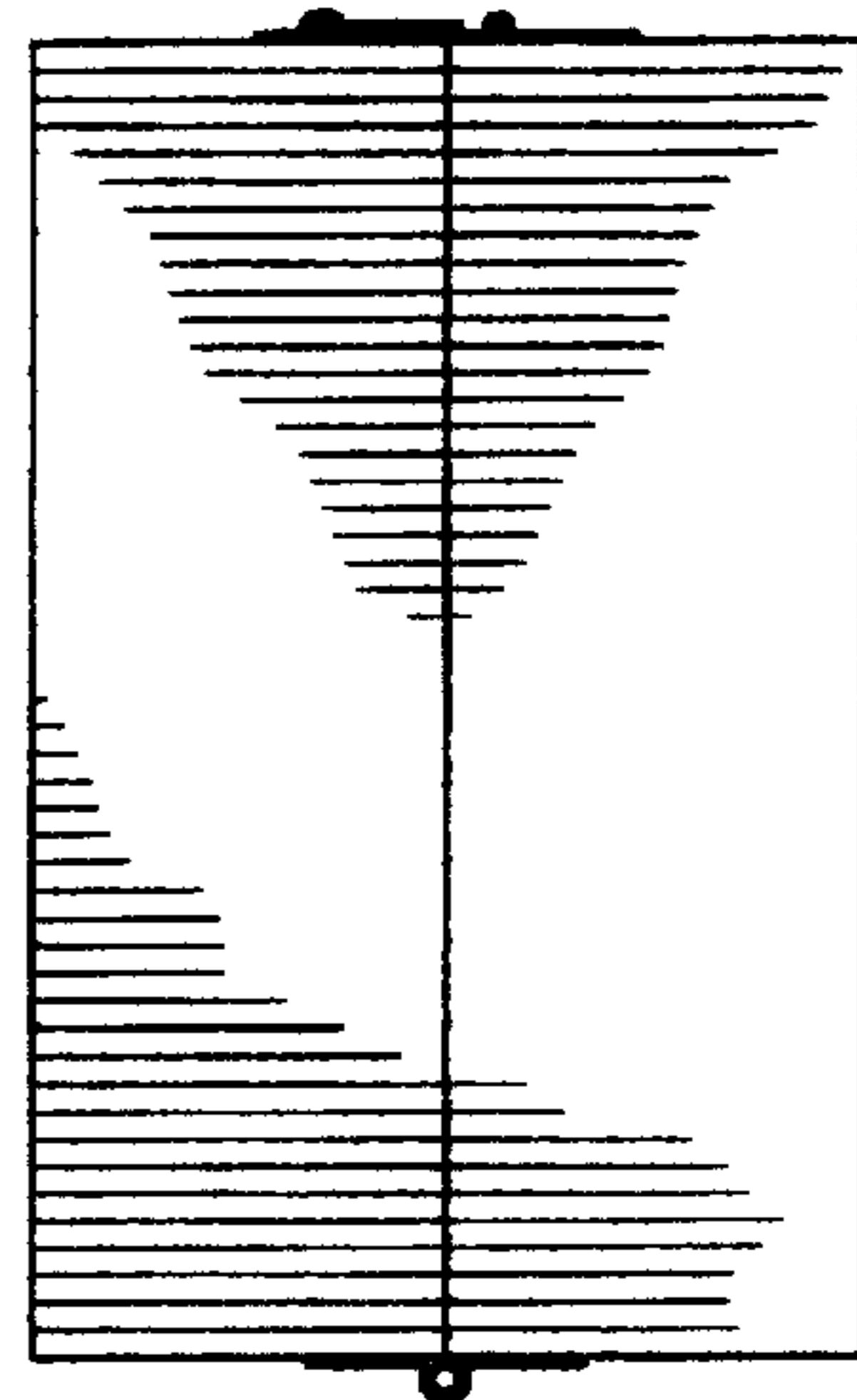

FIG. 5