



US00D393181S

# United States Patent [19]

[11] Patent Number: **Des. 393,181**

**Panta**

[45] Date of Patent: **\*\*Apr. 7, 1998**

## [54] SERVING TRAY

## OTHER PUBLICATIONS

[75] Inventor: **Hector Virgilio Panta**, Guayaquil, Ecuador

Tennis Racket Server, Gifts and Decorative Accessories p. 146. Jan. 1980.

[73] Assignee: **Pantalimentos, Cia Ltda.**, Guayaquil

*Primary Examiner*—M. N. Pandozzi  
*Attorney, Agent, or Firm*—Brinks Hofer Gilson & Lione

[\*\*] Term: **14 Years**

## [57] CLAIM

[21] Appl. No.: **43,628**

The ornamental design for the serving tray, as shown and described.

[22] Filed: **Sep. 8, 1995**

## DESCRIPTION

## [30] Foreign Application Priority Data

Mar. 7, 1995 [EC] Ecuador ..... SDI-95-235

[51] LOC (6) Cl. .... **07-01**

[52] U.S. Cl. .... **D7/553; D7/555; D7/549**

[58] Field of Search ..... D7/500, 505, 507, D7/538, 701, 540, 541, 542, 546, 547, 549, 550, 552, 553, 554, 555, 557, 601, 602, 610, 619, 620, 612, 340, 551; 220/630, 23.83, 23.8; D32/40, 46, 49; D19/35; D3/313

FIG. 1 is a perspective view showing the serving tray of the present invention;

FIG. 2 is a top view thereof;

FIG. 3 is a sectional view along 3—3, as shown in FIG. 2 thereof;

FIG. 4 is a sectional view along 4—4, as shown in FIG. 2 thereof;

FIG. 5 is a sectional view along 5—5, as shown in FIG. 2 thereof;

FIG. 6 is a sectional view along 6—6, as shown in FIG. 2 thereof;

FIG. 7 is a sectional view along 7—7, as shown in FIG. 2 thereof;

FIG. 8 is a first side view thereof;

FIG. 9 is a second side view thereof;

FIG. 10 is a front view thereof;

FIG. 11 is a rear view thereof;

FIG. 12 is an enlarged fragmentary view of the surface of the bottom of the larger well;

FIG. 13 is a sectional view along 13—13 as shown in FIG. 12; and,

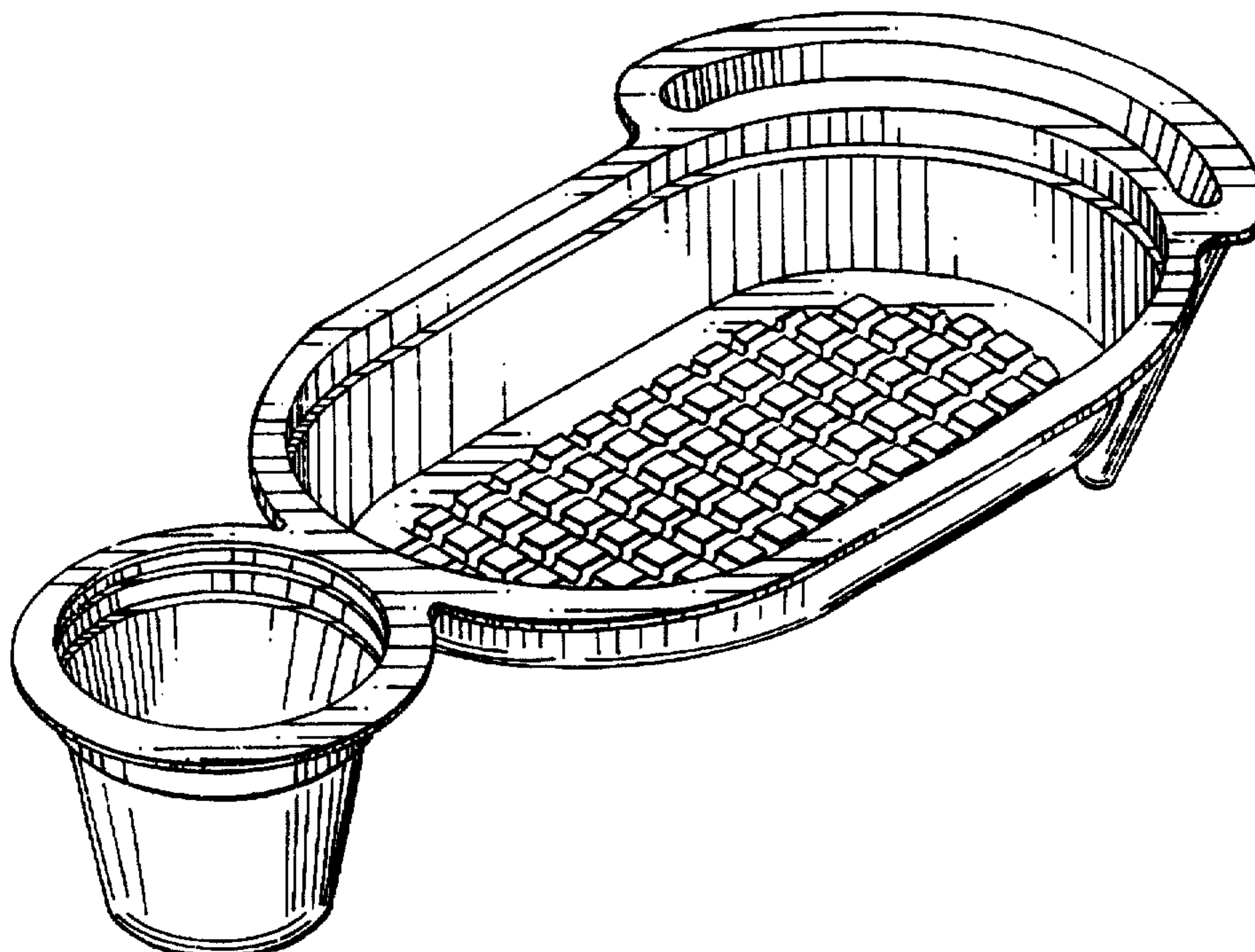
FIG. 14 is a bottom view thereof.

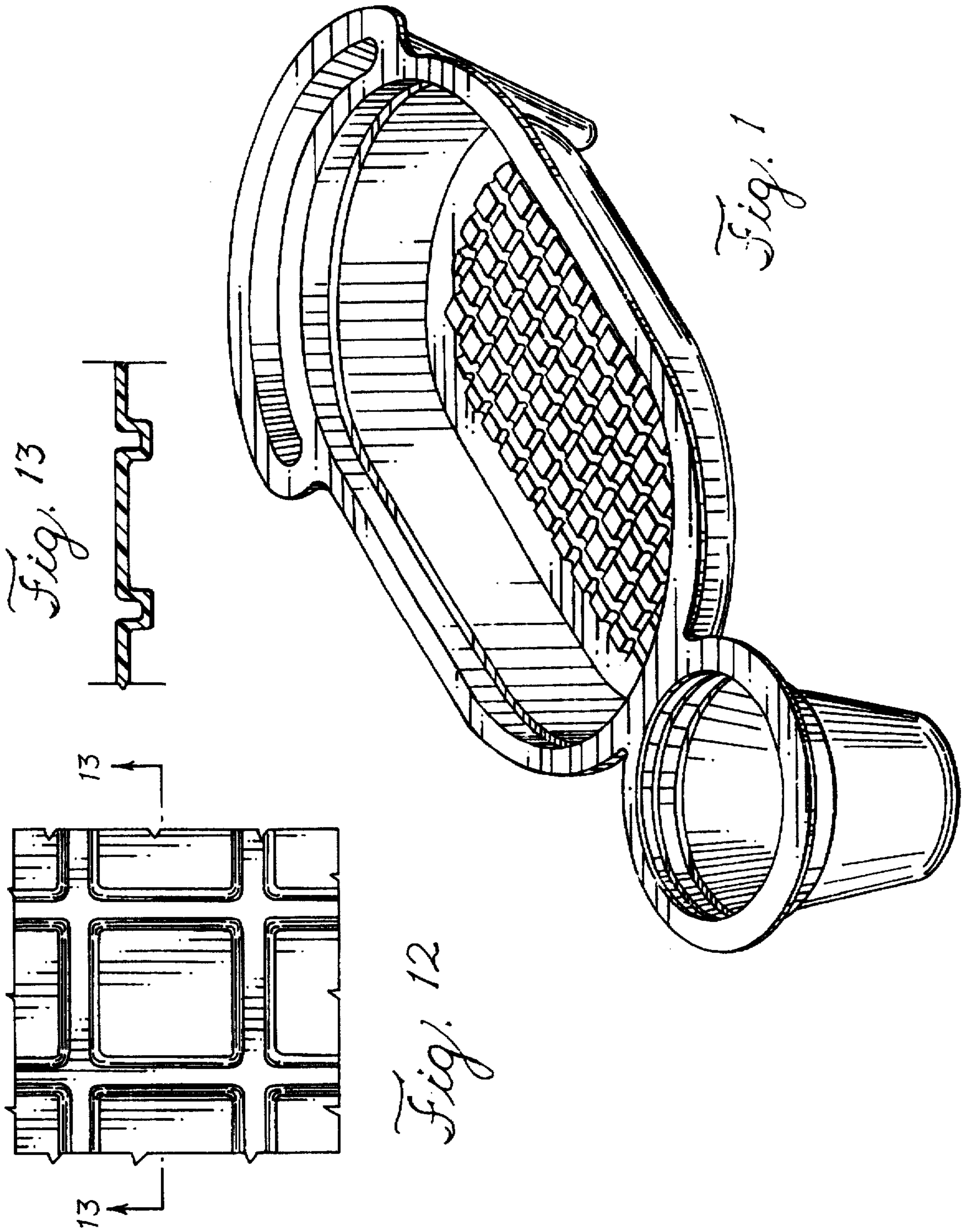
## [56] References Cited

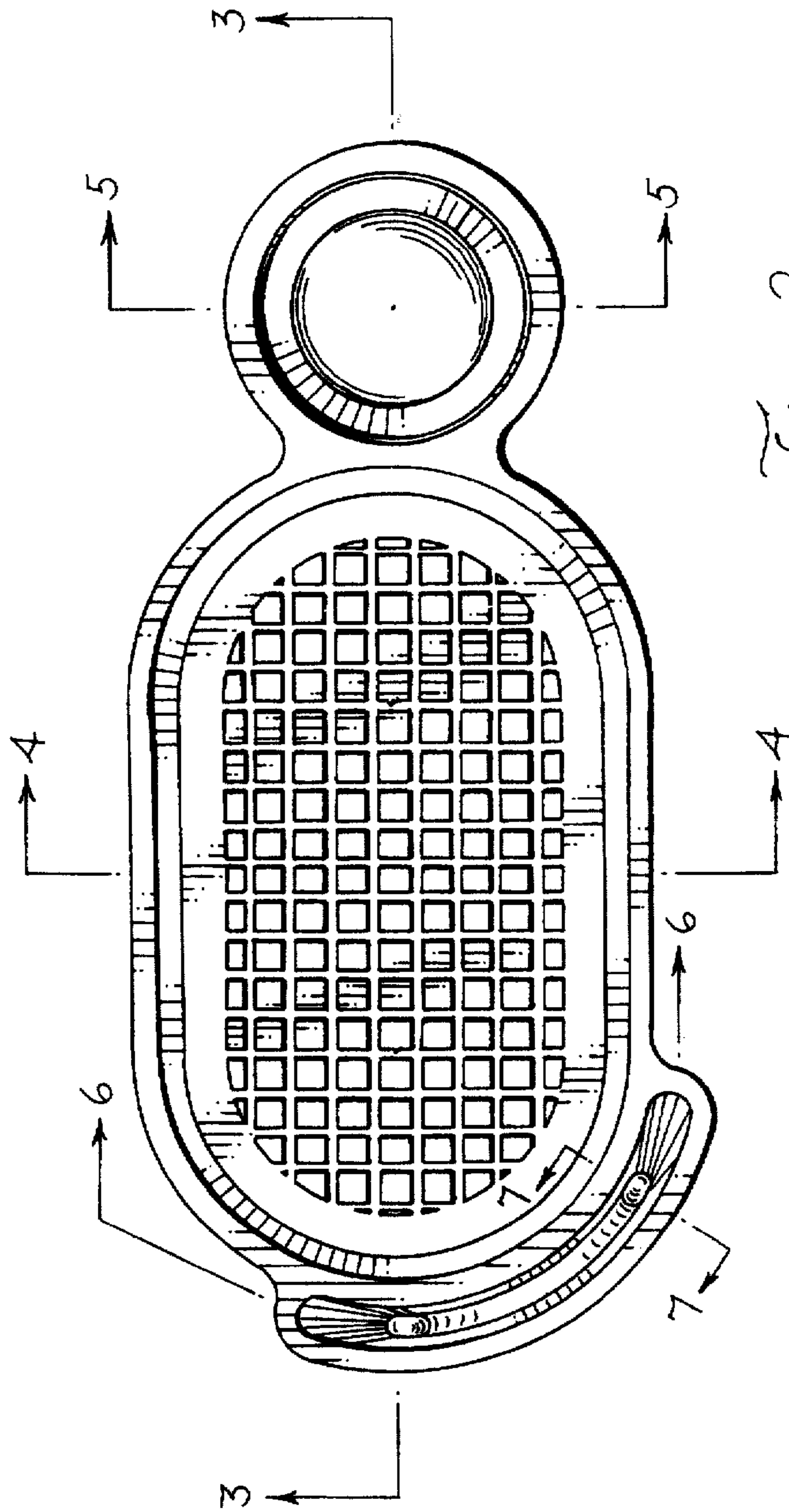
### U.S. PATENT DOCUMENTS

292,651	1/1884	Hentschke	.....	220/23.83
D. 307,529	5/1990	Baetens	.....	D7/549
D. 331,860	12/1992	Stanfield	.....	D7/555 X
D. 336,217	6/1993	Picozza	.....	D7/555 X
D. 353,212	12/1994	Lewis et al.	.....	D7/549 X
2,003,895	6/1935	Martin	.....	D7/555 X
3,110,303	11/1963	Brownrigg	.....	D7/360
4,516,685	5/1985	French	.....	220/23.83
4,989,422	2/1991	Powell	.....	D7/554 X
5,110,170	5/1992	Boatwright	.....	D7/507 X
5,259,528	11/1993	Pace et al.	.....	220/23.8 X

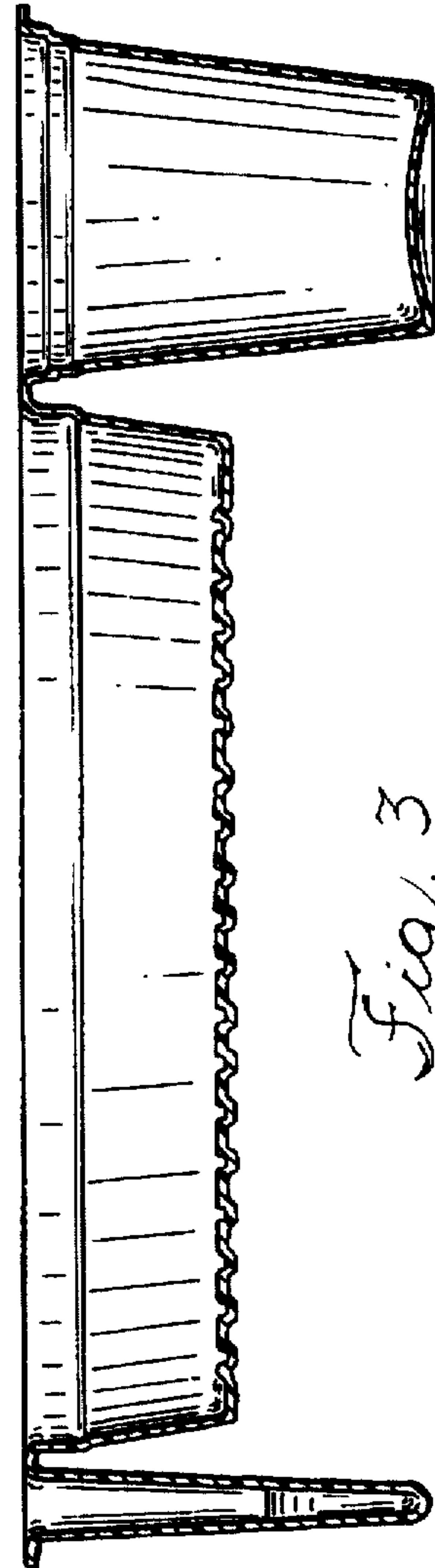
**1 Claim, 5 Drawing Sheets**





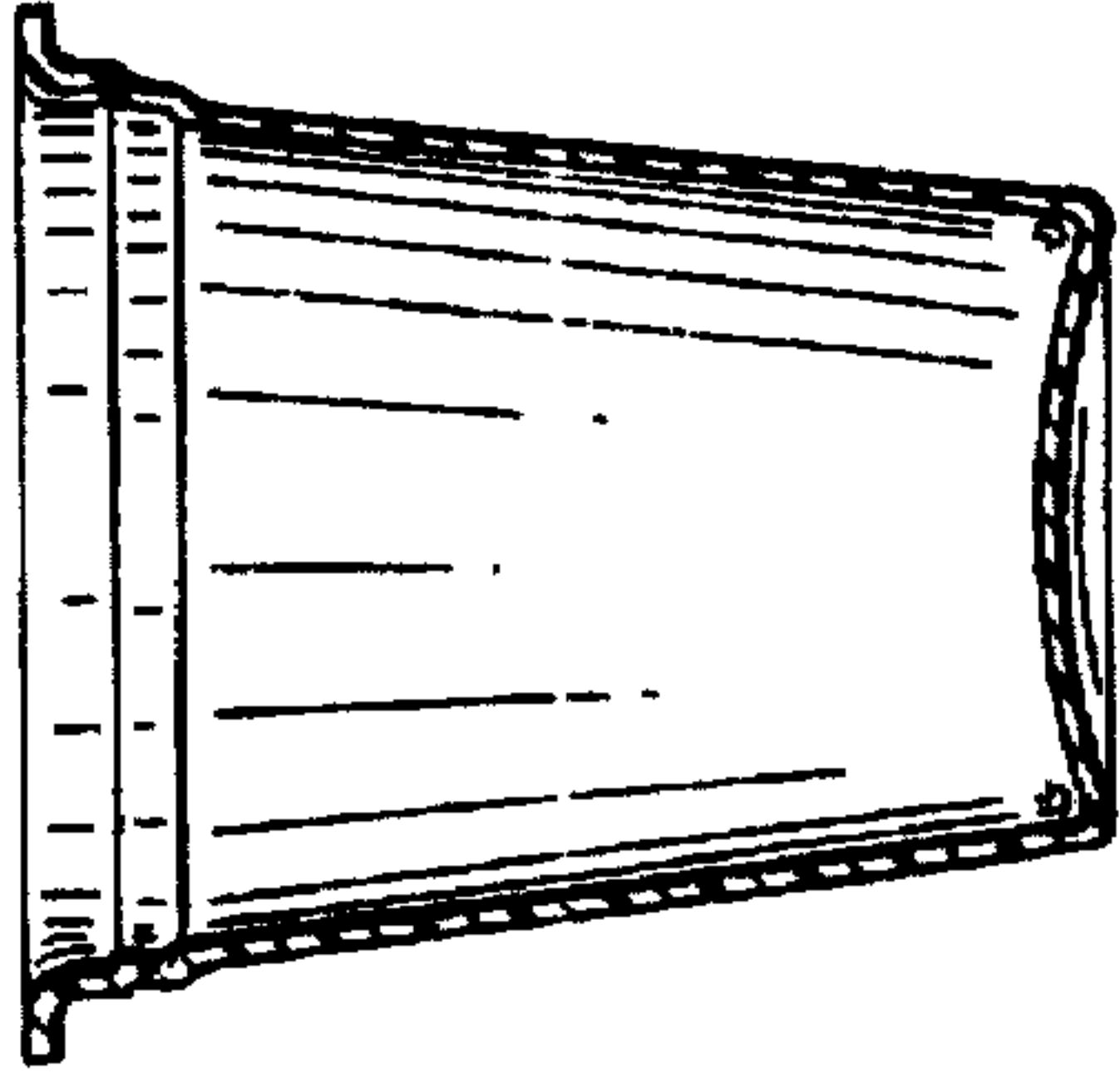


*Fig. 2*

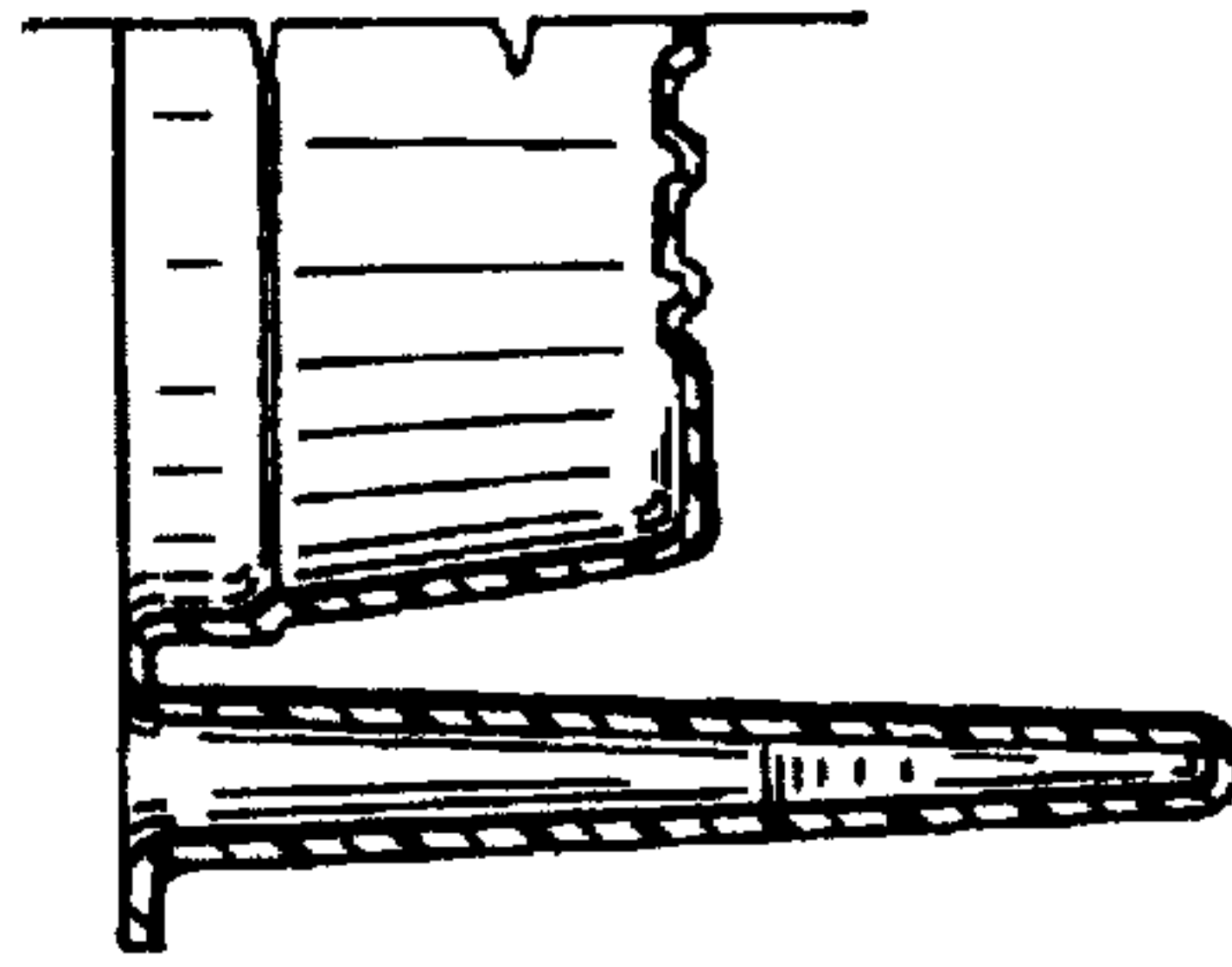


*Fig. 3*

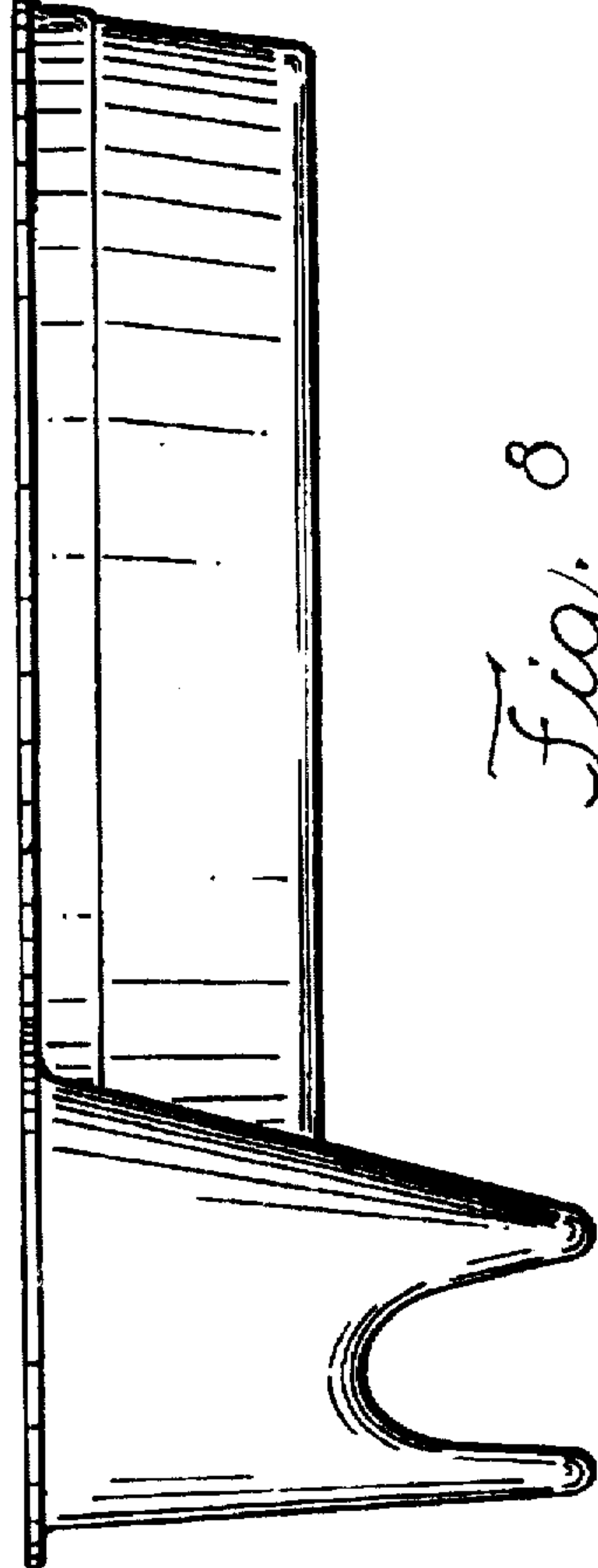
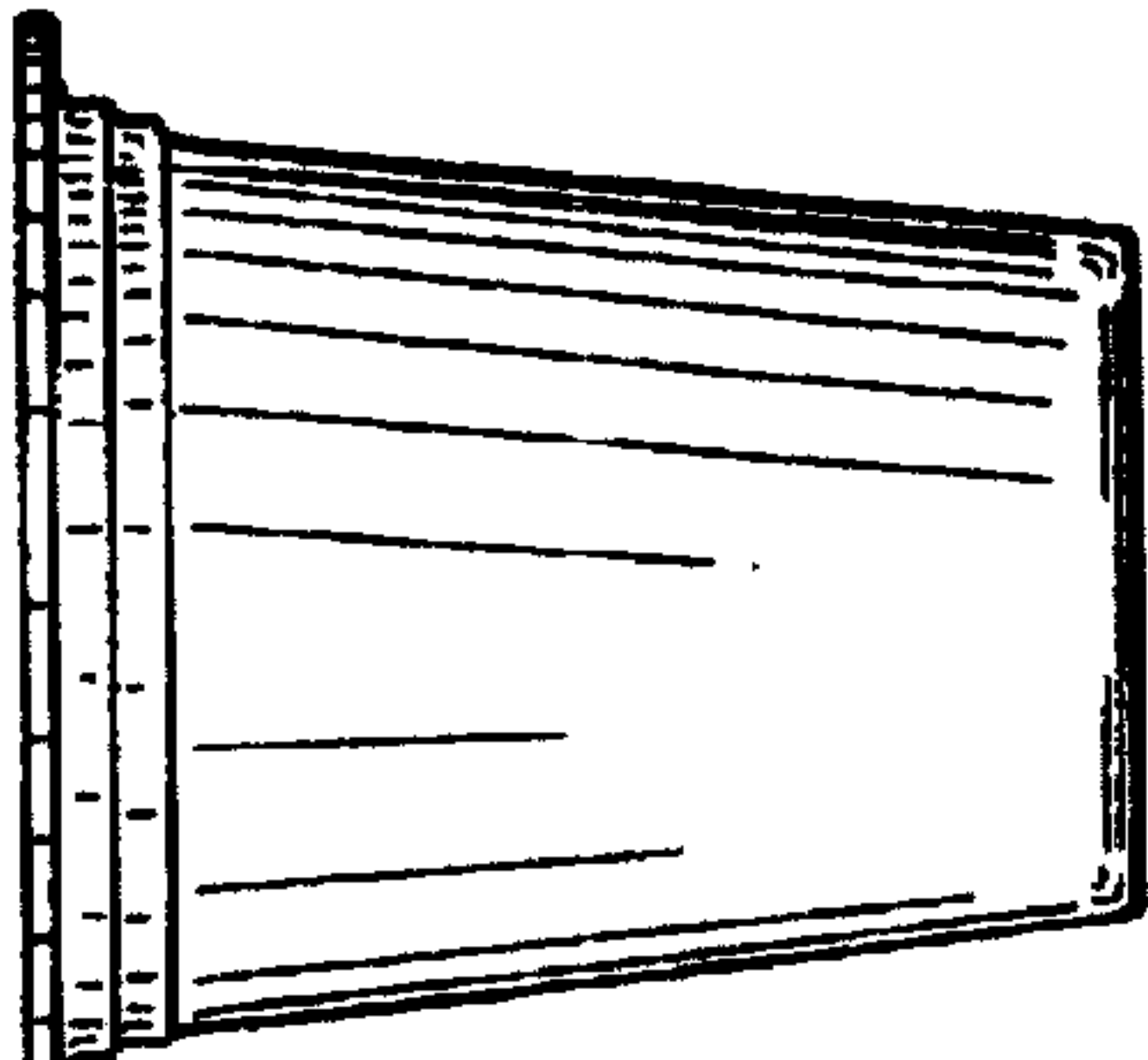




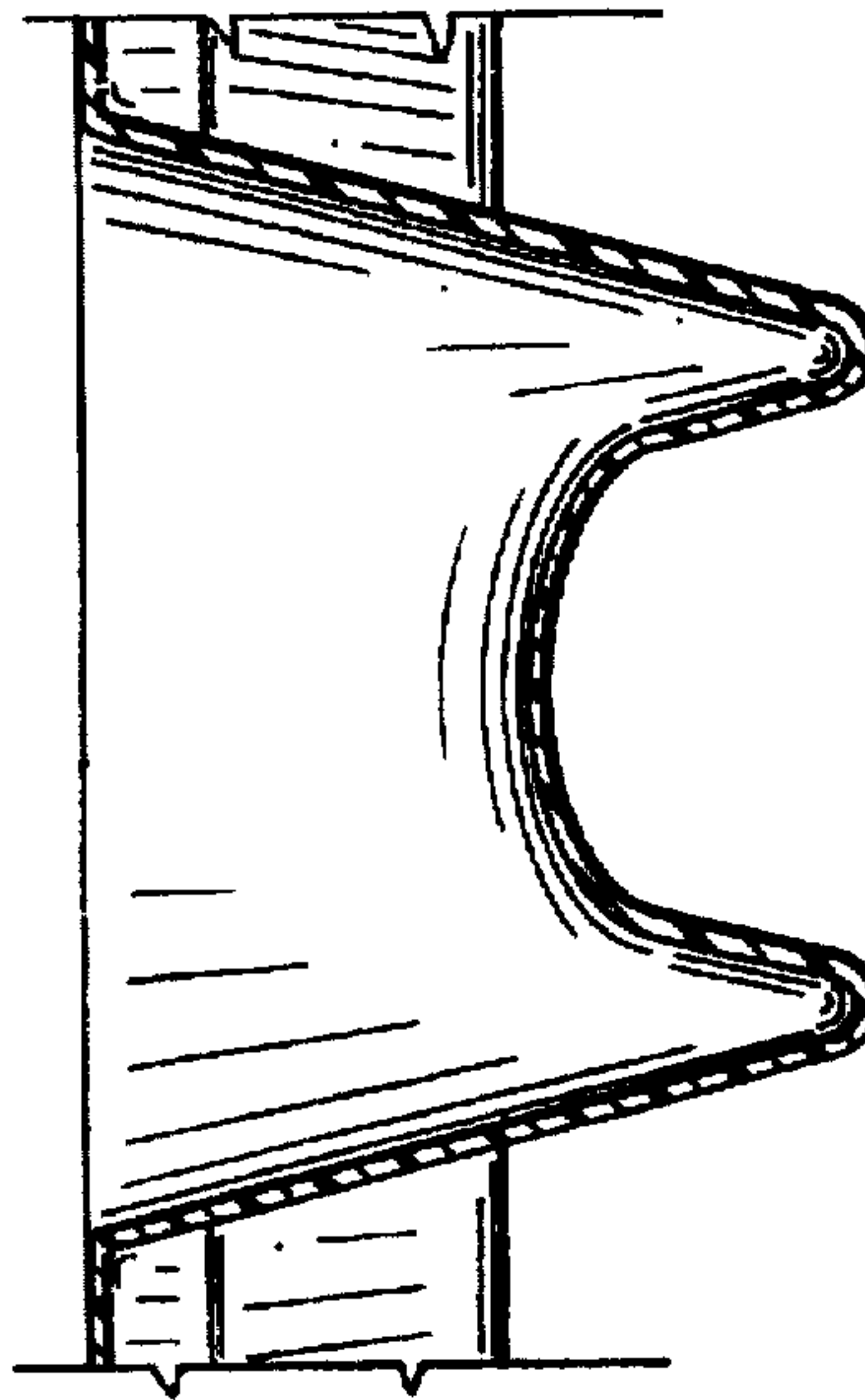
*Fig. 5*



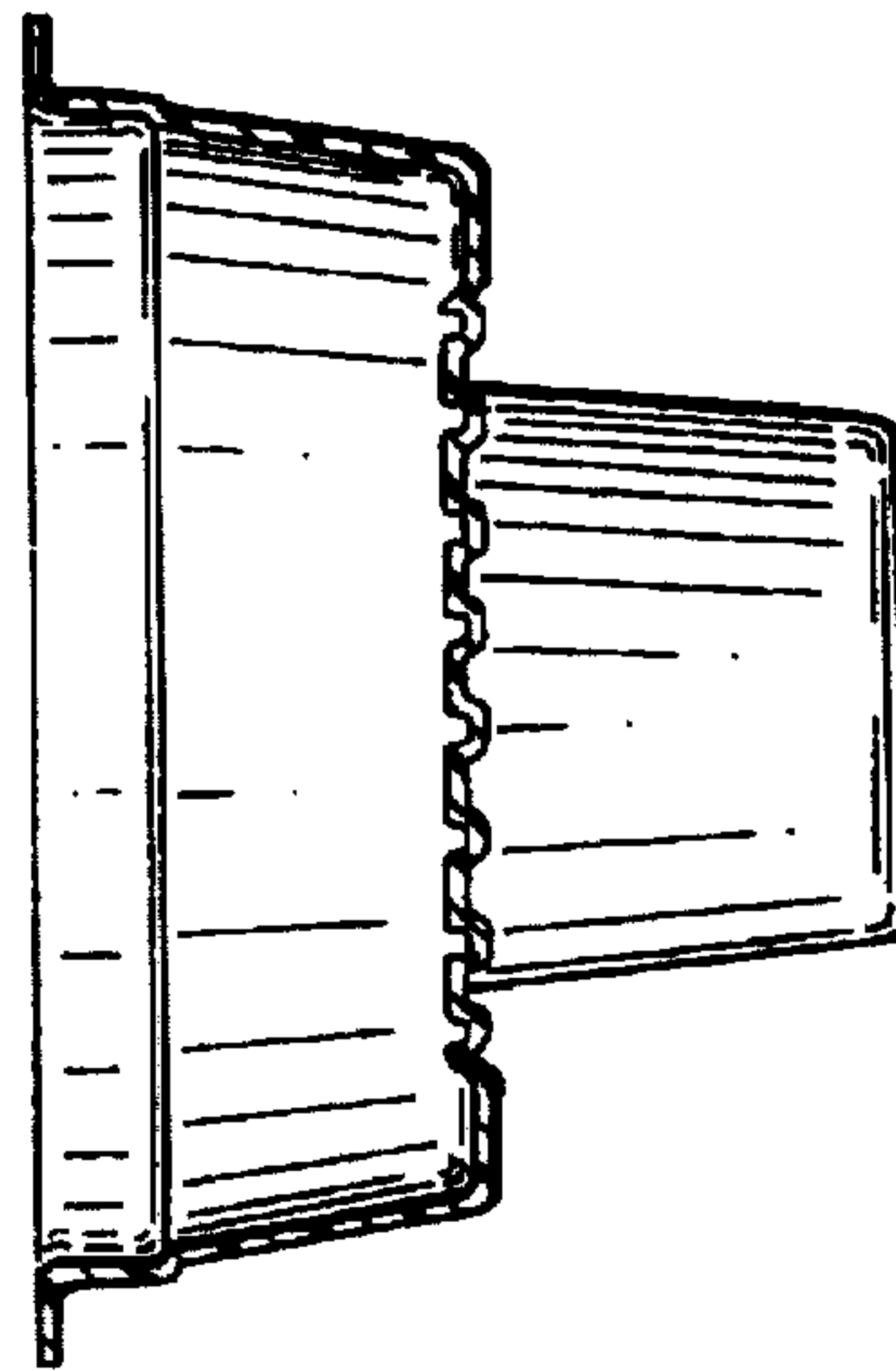
*Fig. 7*



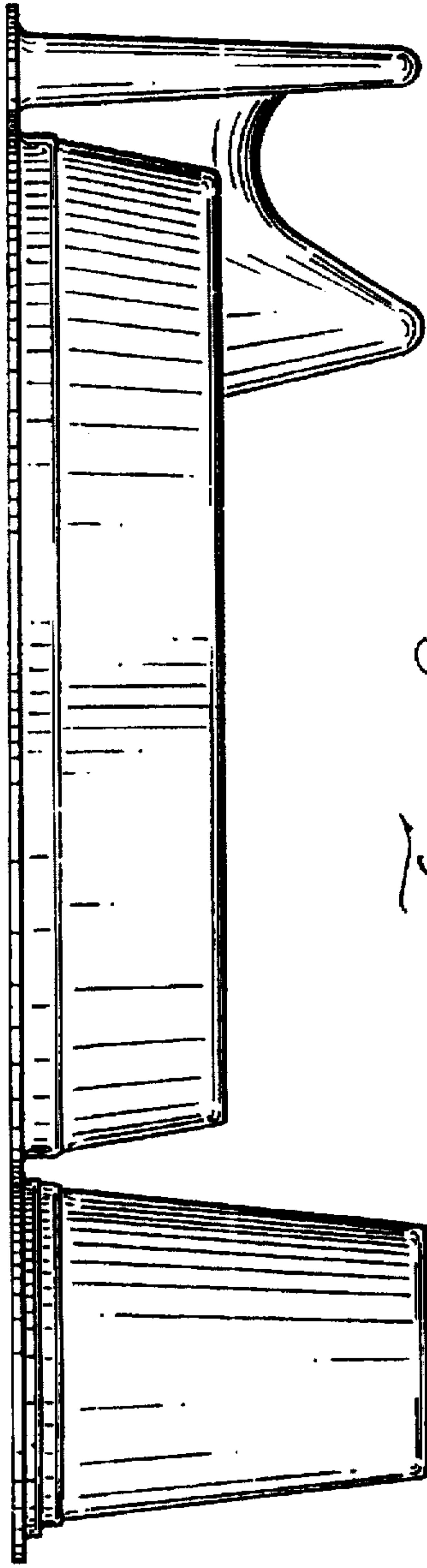
*Fig. 8*



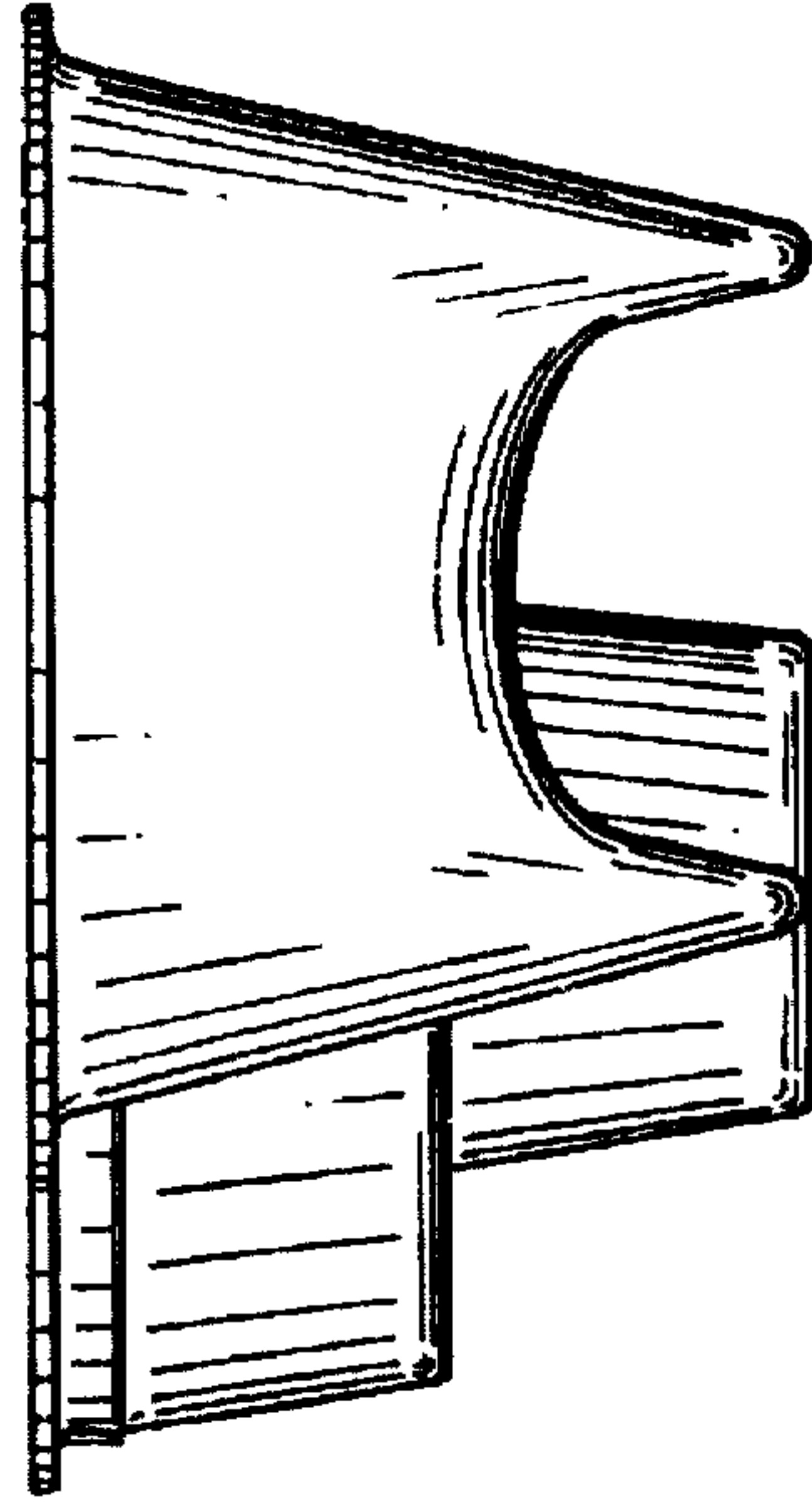
*Fig. 6*



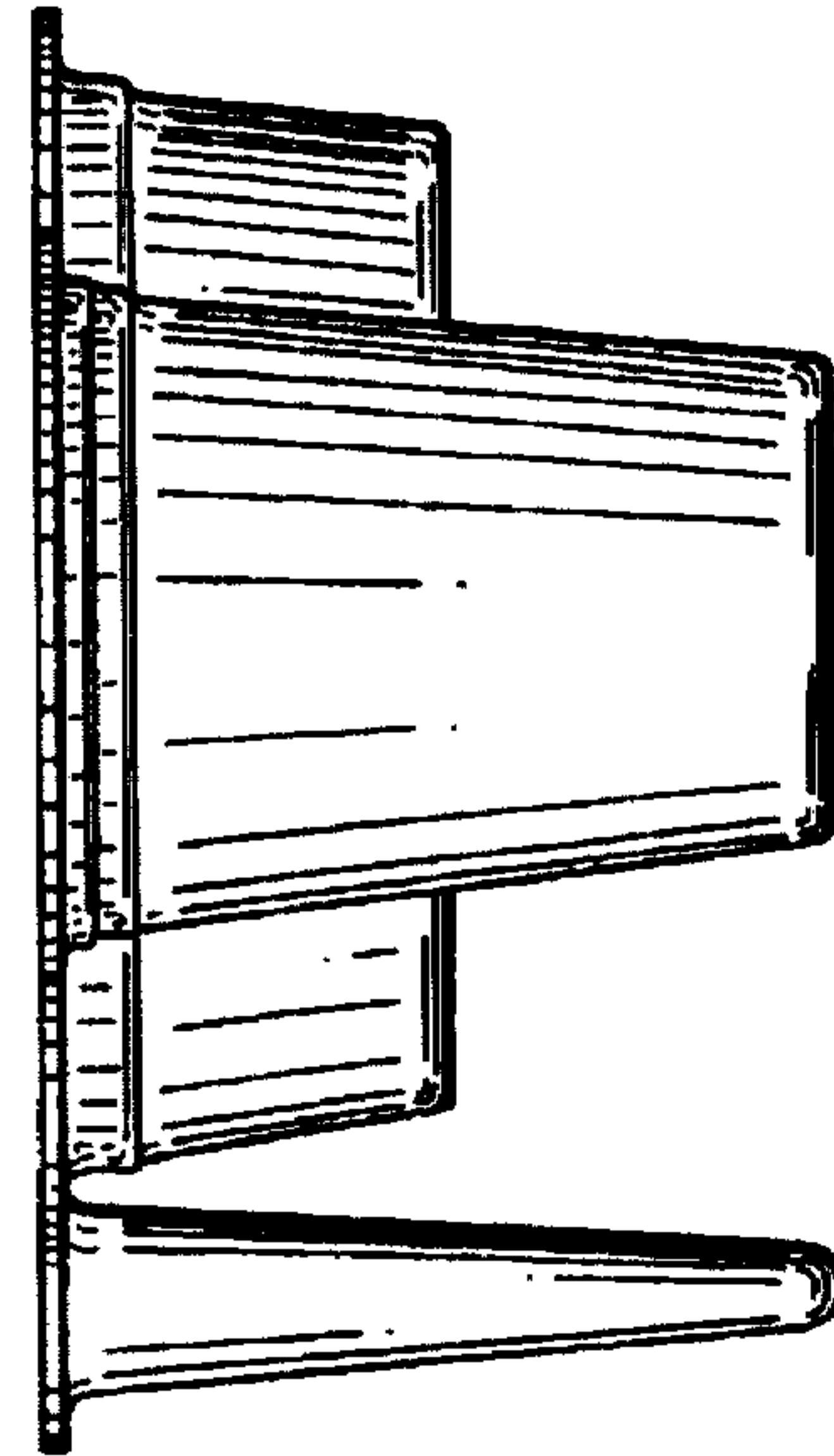
*Fig. 4*



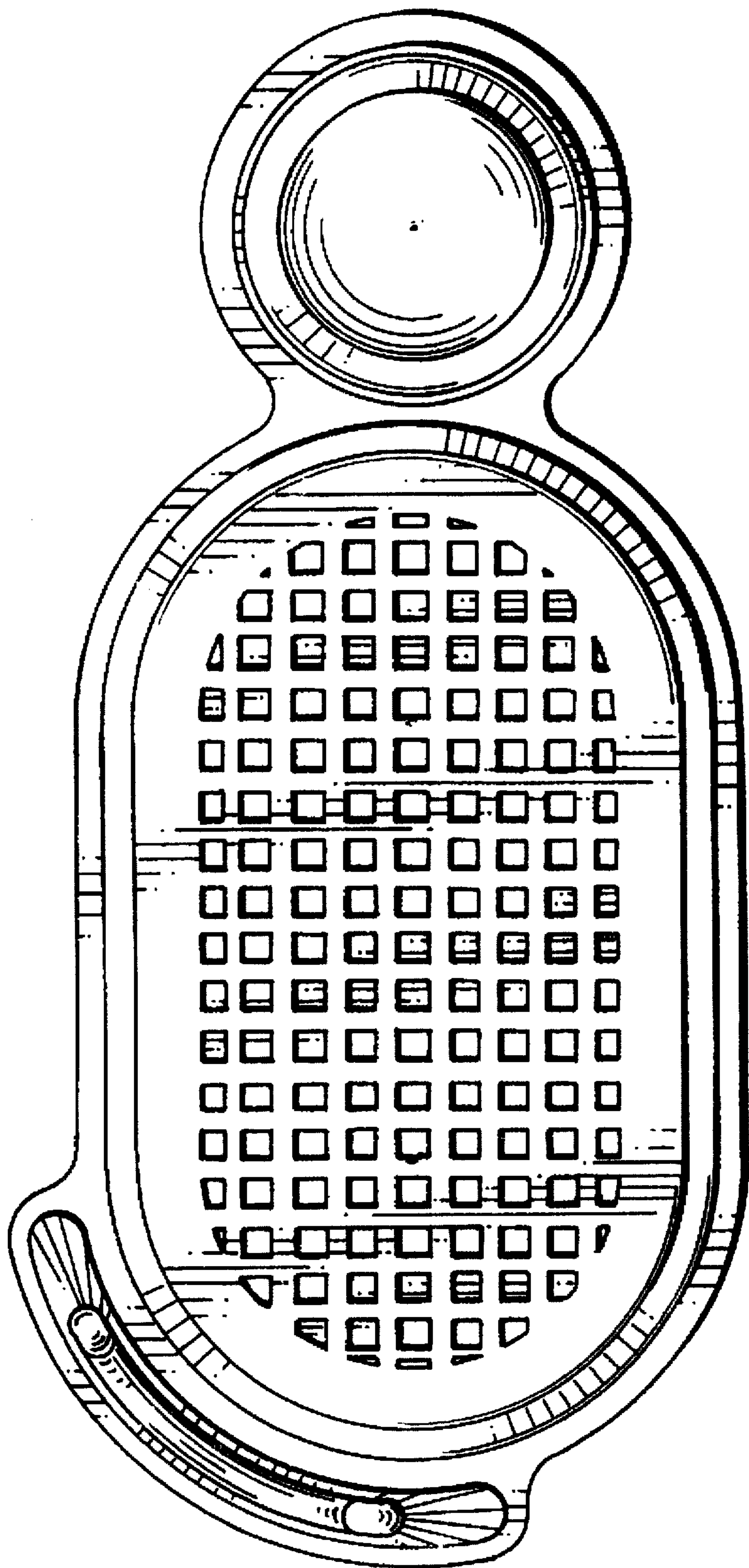
*Fig. 9*



*Fig. 11*



*Fig. 10*



*Fig. 14*