



US00D393168S

United States Patent [19]

Arcese et al.

[11] Patent Number: Des. 393,168

[45] Date of Patent: **Apr. 7, 1998

[54] **DISPENSER FOR LIQUIDS**

[76] Inventors: **Edward R. Arcese**, 501 Lexington St.
Unit #48, Waltham, Mass. 02154;
Edward R. Arcese, Jr., 52 Fitzgerald
Rd., Marlborough, Mass. 01752

[**] Term: 14 Years

[21] Appl. No.: 72,020

[22] Filed: Jun. 2, 1997

[51] LOC (6) Cl. 07-07

[52] U.S. Cl. D6/545

[58] Field of Search D6/542-545; 221/208,
221/282, 283; 222/105, 173, 180, 181.1,
630

[56] **References Cited**

U.S. PATENT DOCUMENTS

D. 383,631 9/1997 Wirt et al. D6/545
4,946,072 8/1990 Albert 222/105

Primary Examiner—Brian N. Vinson
Attorney, Agent, or Firm—Mark P. White

[57] **CLAIM**

The ornamental design for a dispenser for liquids, as shown and described.

DESCRIPTION

FIG. 1 is a front elevational view of a dispenser for liquids showing our new design;

FIG. 2 is a right side elevational view thereof, the left side being a mirror image of that shown;

FIG. 3 is a top plan view thereof;

FIG. 4 is a bottom plan view thereof; and,

FIG. 5 is a rear elevational view thereof.

1 Claim, 3 Drawing Sheets

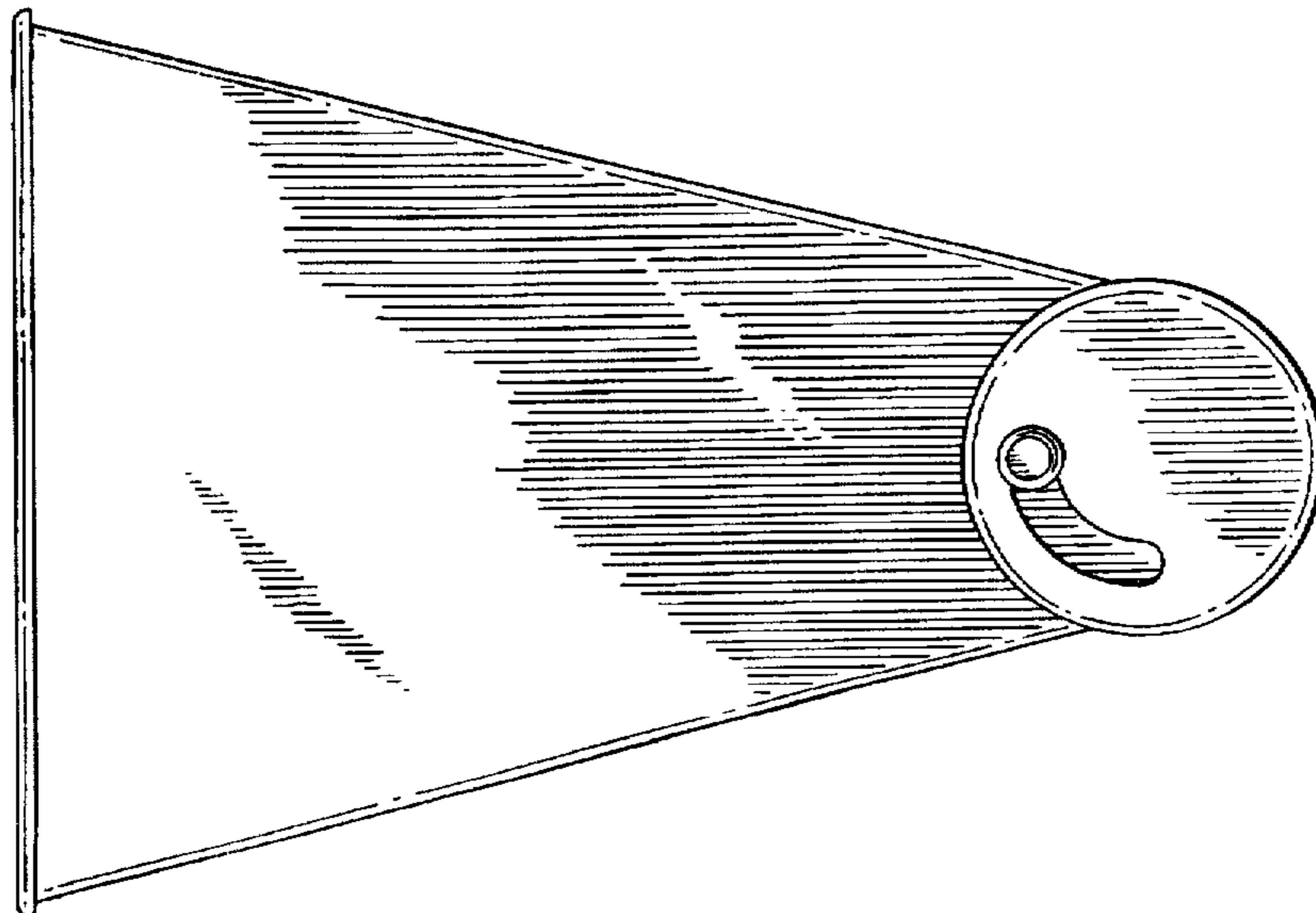
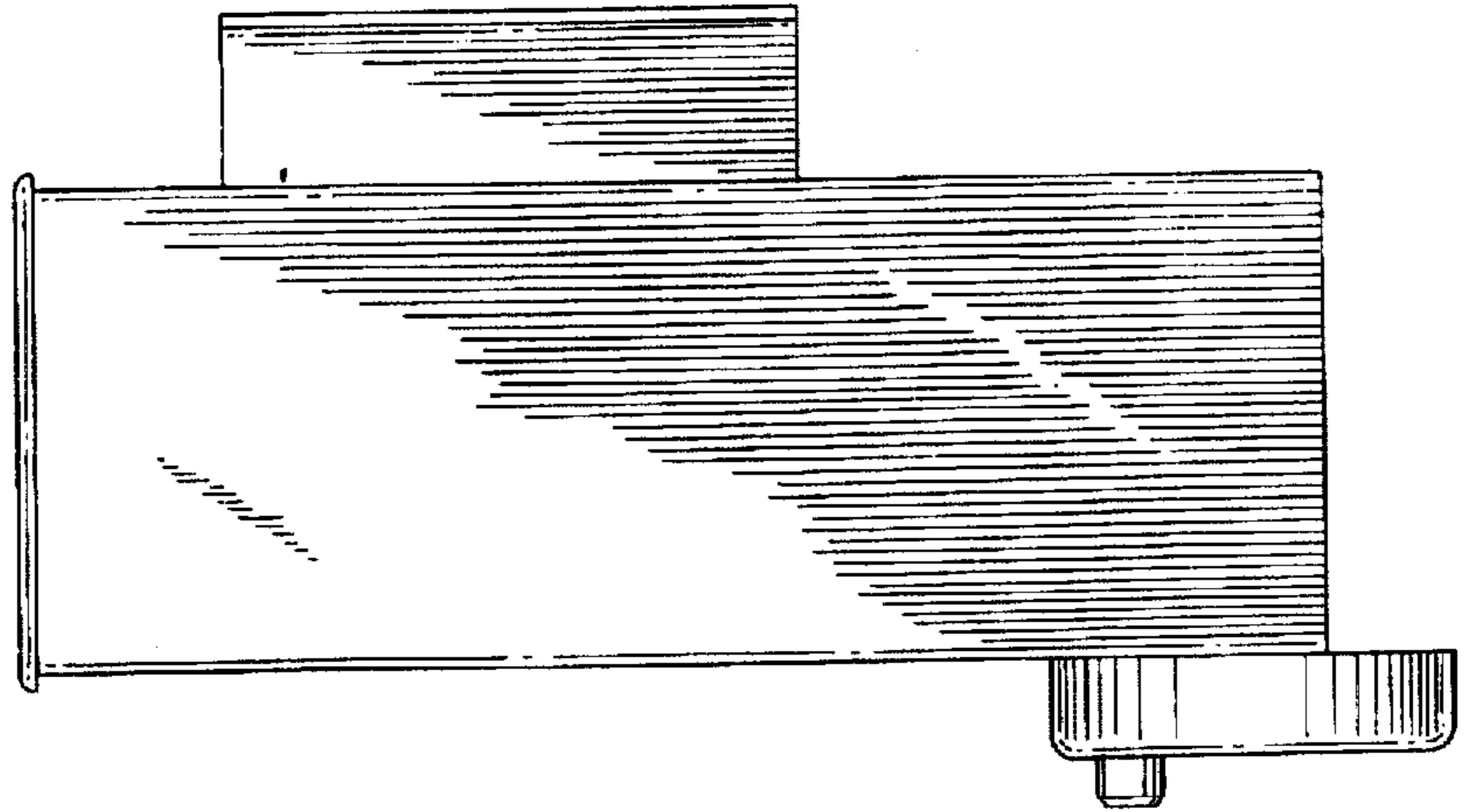

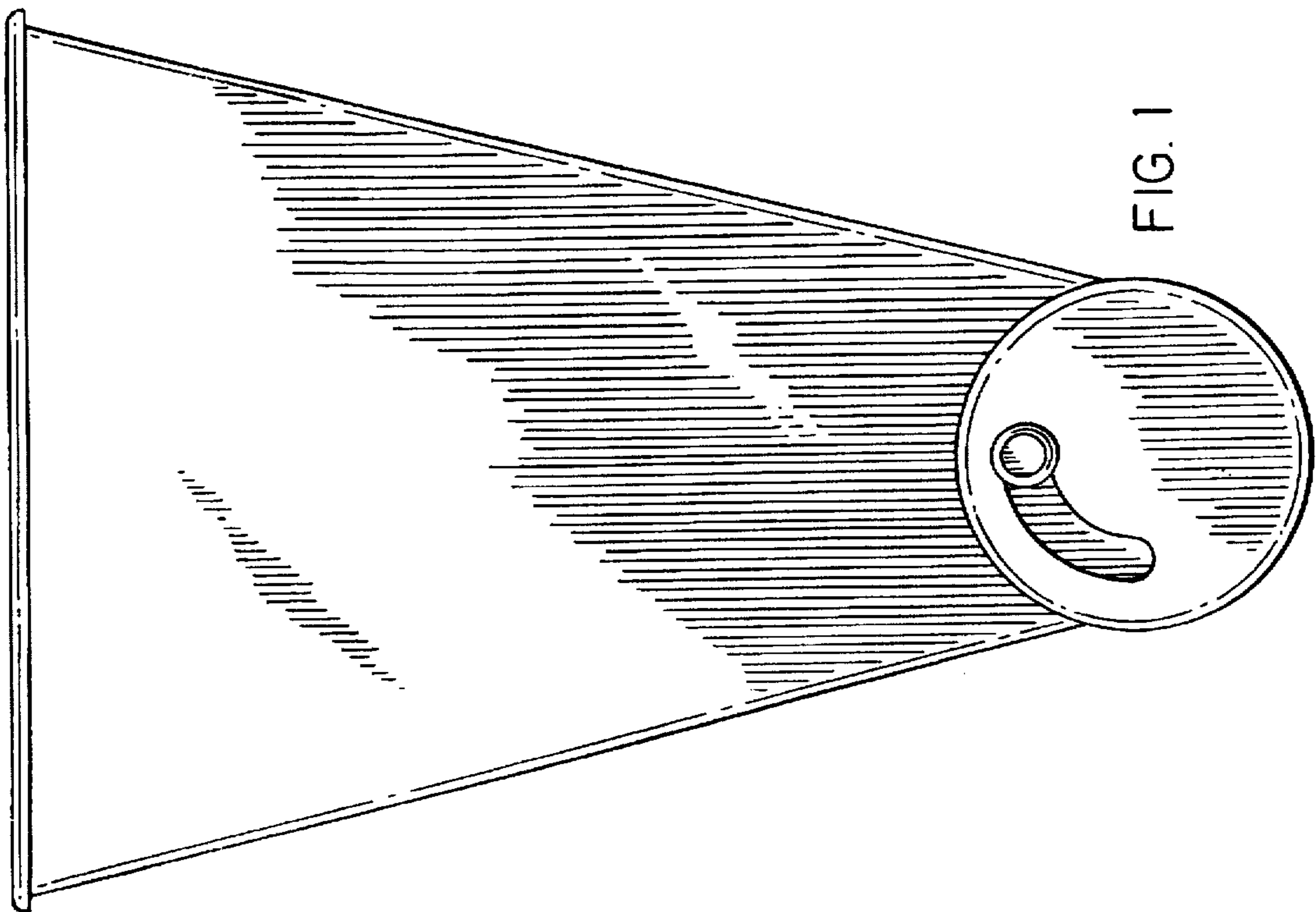
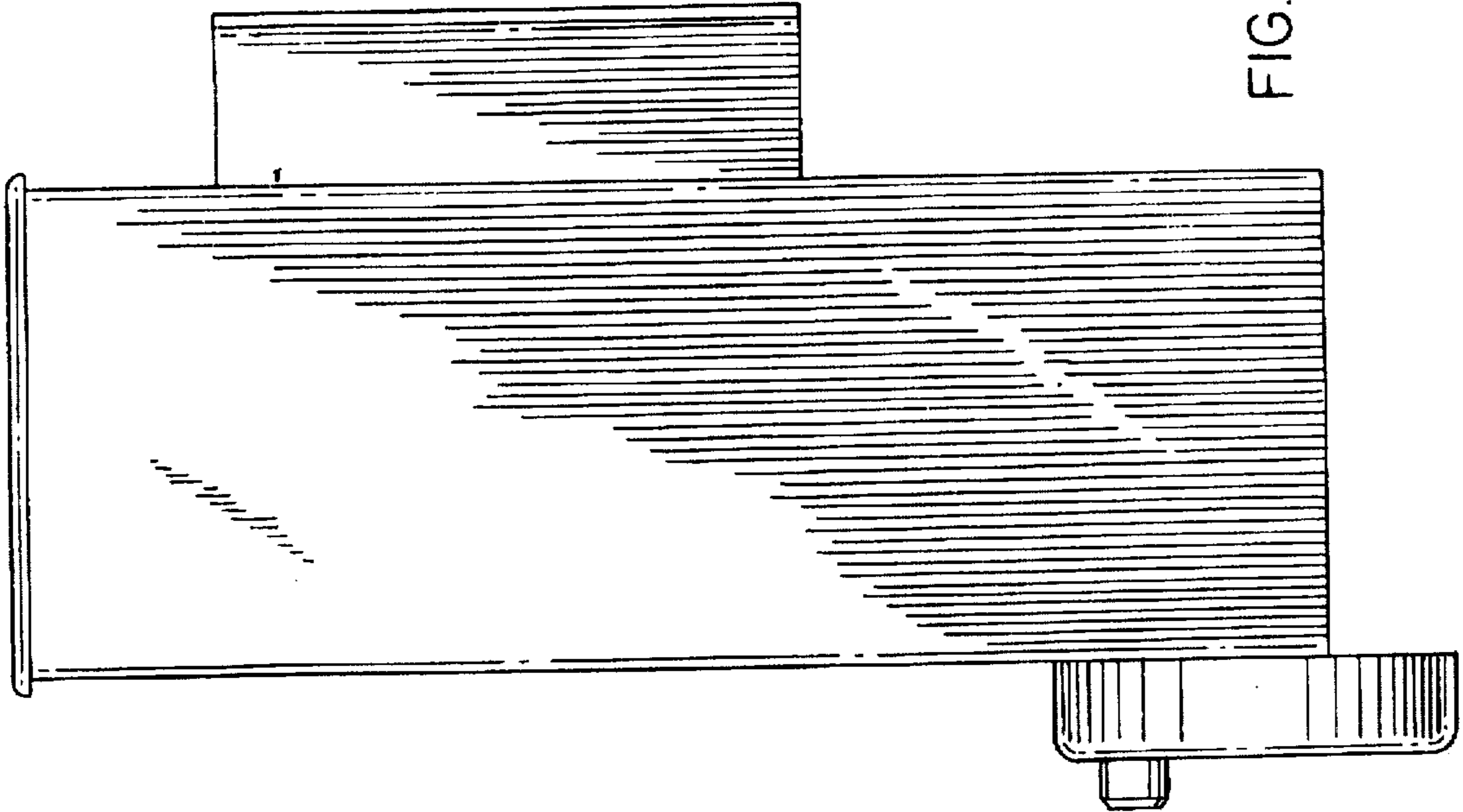

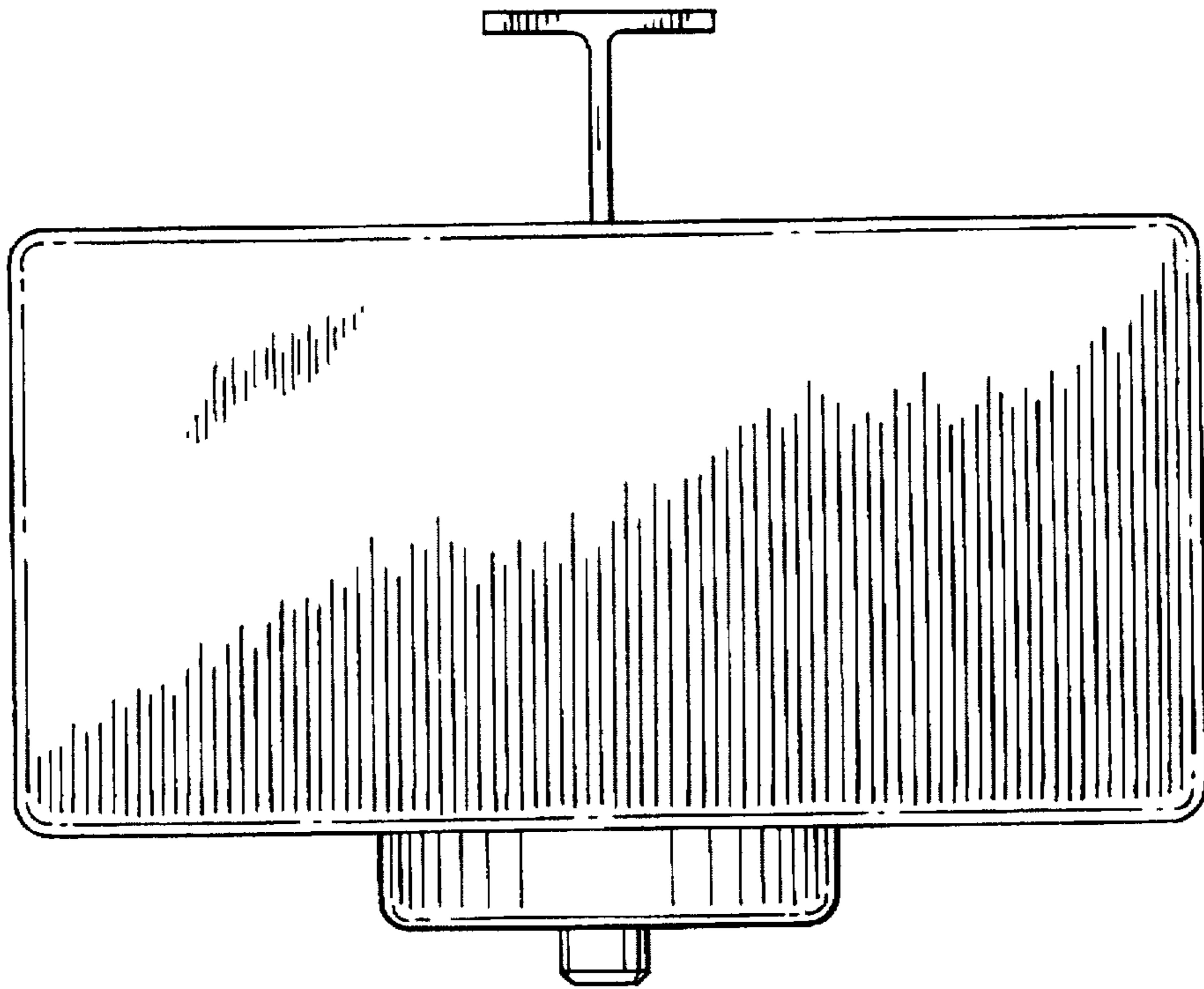

FIG. 3

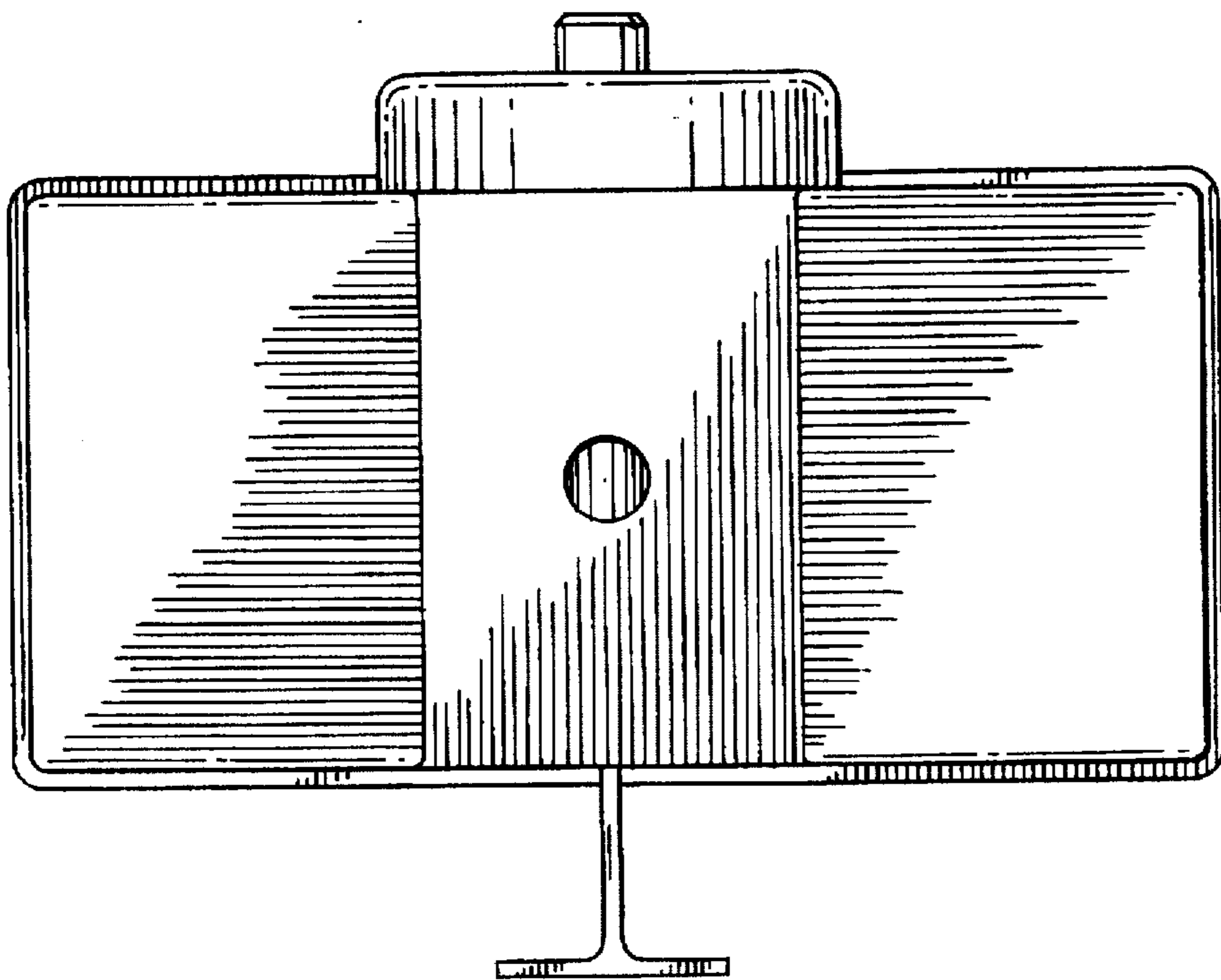

FIG. 4

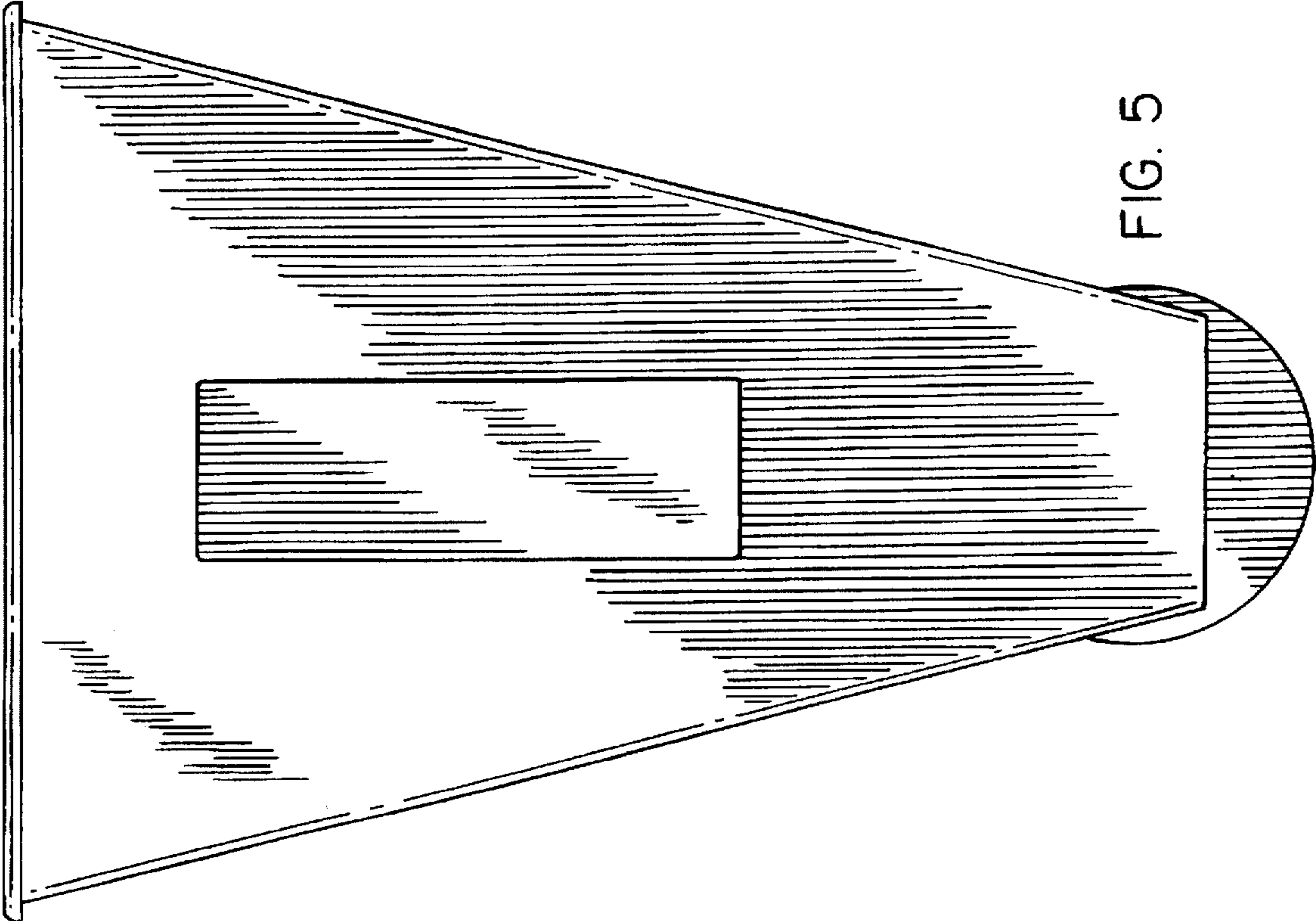

FIG. 5