

US00D393118S

United States Patent [19]

Garrett et al.

[11] Patent Number: **Des. 393,118**

[45] Date of Patent: ****Mar. 31, 1998**

[54] **IRON**

D. 291,616 8/1987 Henny D32/70
D. 309,516 7/1990 Klok D32/70

[75] Inventors: **Barbara Garrett**, South Miami, Fla.;
Chi Kin Mak, Wan Chan, Hong Kong

Primary Examiner—Susan J. Lucas
Assistant Examiner—Cynthia E. Ramirez
Attorney, Agent, or Firm—Dickstein, Shapiro Morin &
Oshinsky LLP

[73] Assignee: **Windmere-Durable Holdings, Inc.**,
Miami Lakes, Fla.

[**] Term: **14 Years**

[57] CLAIM

[21] Appl. No.: **64,822**

The ornamental design for an iron, as shown and described.

[22] Filed: **Jan. 10, 1997**

DESCRIPTION

[51] LOC (6) Cl. **07-05**

[52] U.S. Cl. **D32/70**

[58] Field of Search D32/68, 70, 71,
D32/69, 72, 73; 219/245, 246, 247, 254,
273, 275, 276, 77.7, 77.9, 79, 88, 77.2;
38/69, 74, 77.1, 77.2, 77.5, 77.7, 77.8

FIG. 1 is a bottom, front and left view showing my new design;

FIG. 2 is a front view thereof;

FIG. 3 is a back view thereof;

FIG. 4 is a top view thereof;

FIG. 5 is a bottom view thereof;

FIG. 6 is a left side view thereof; and,

FIG. 7 is a right side view thereof.

[56] References Cited

U.S. PATENT DOCUMENTS

D. 290,891 7/1987 Stutzer et al. D32/70

1 Claim, 6 Drawing Sheets

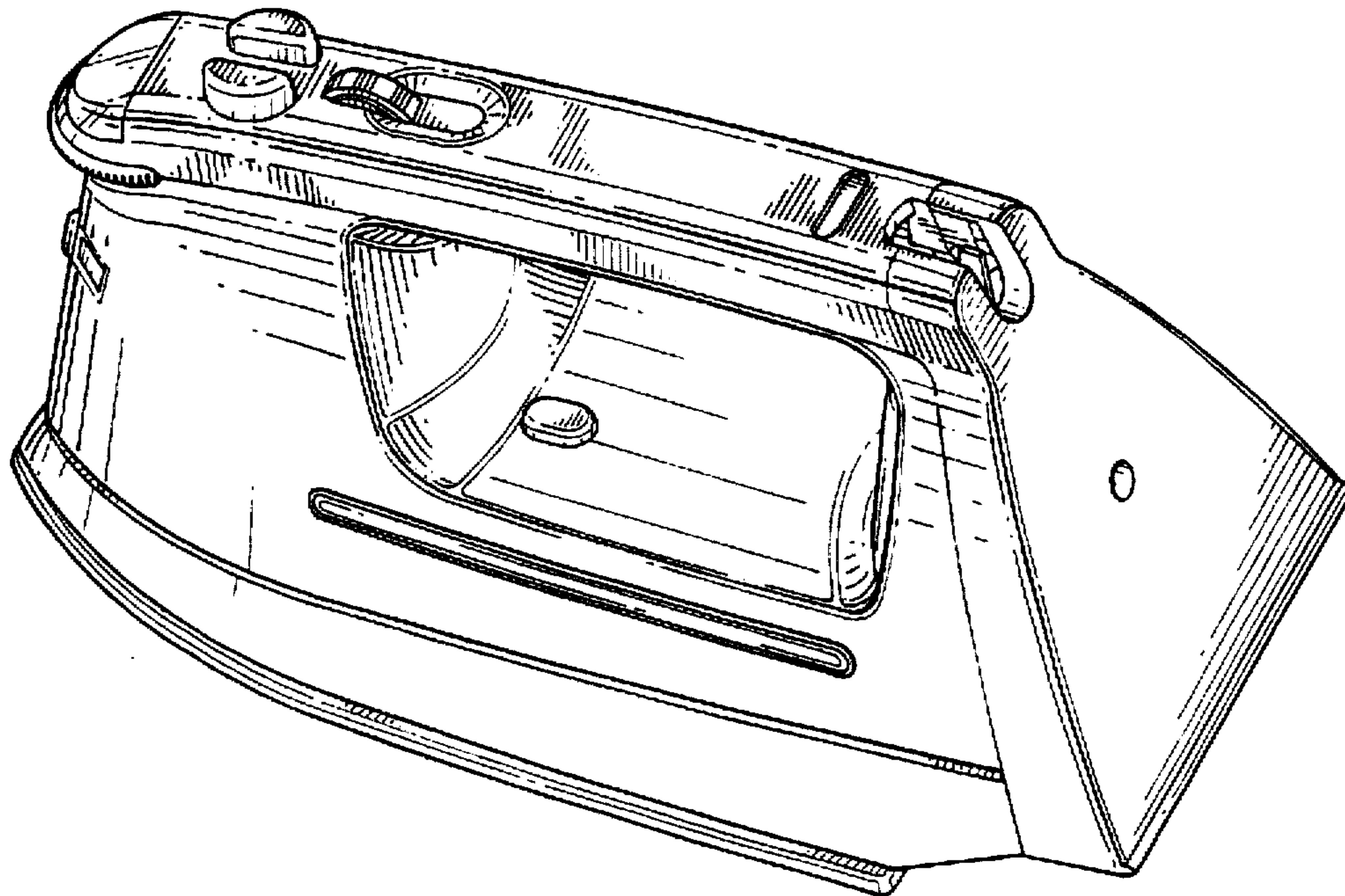

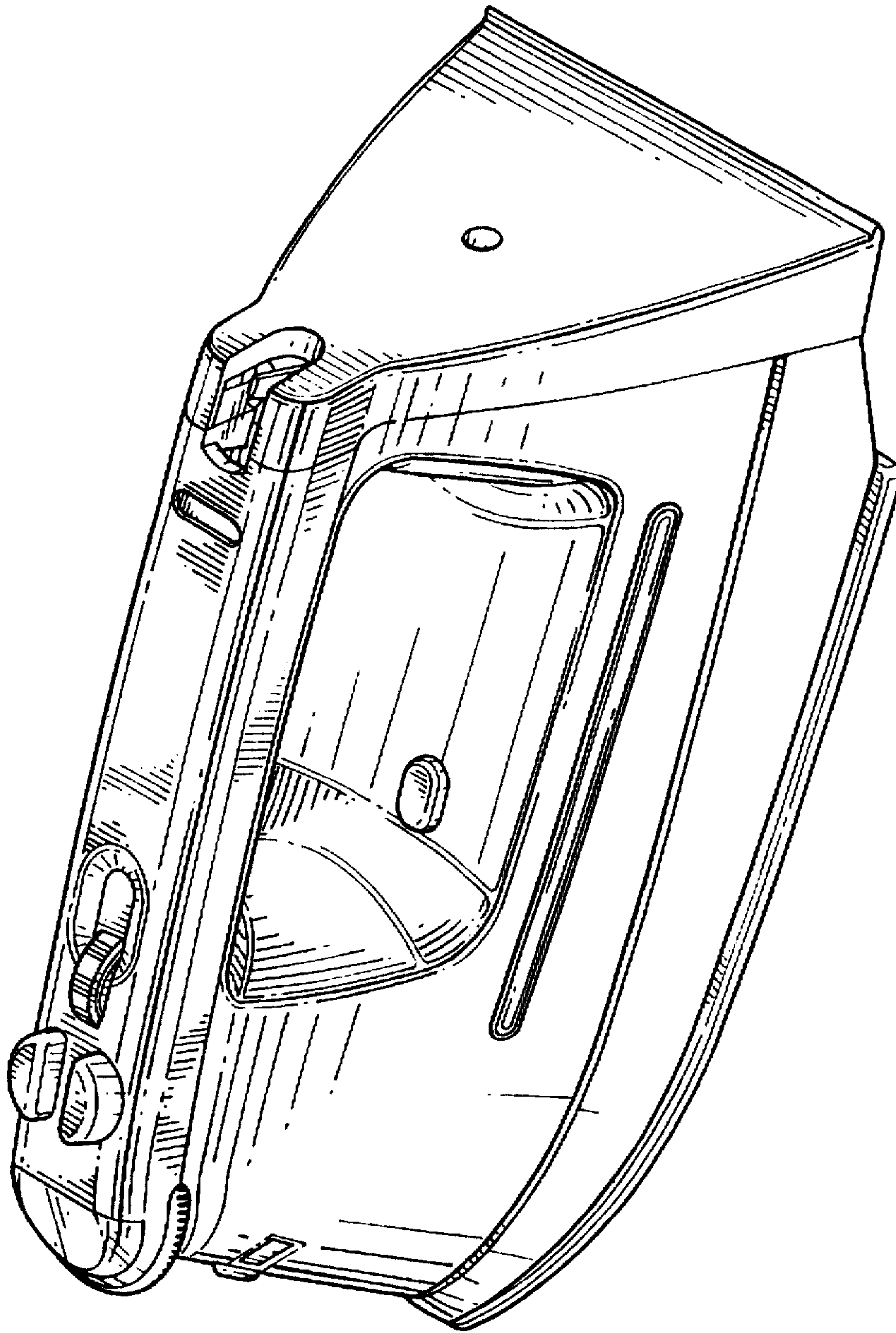

FIG. 1

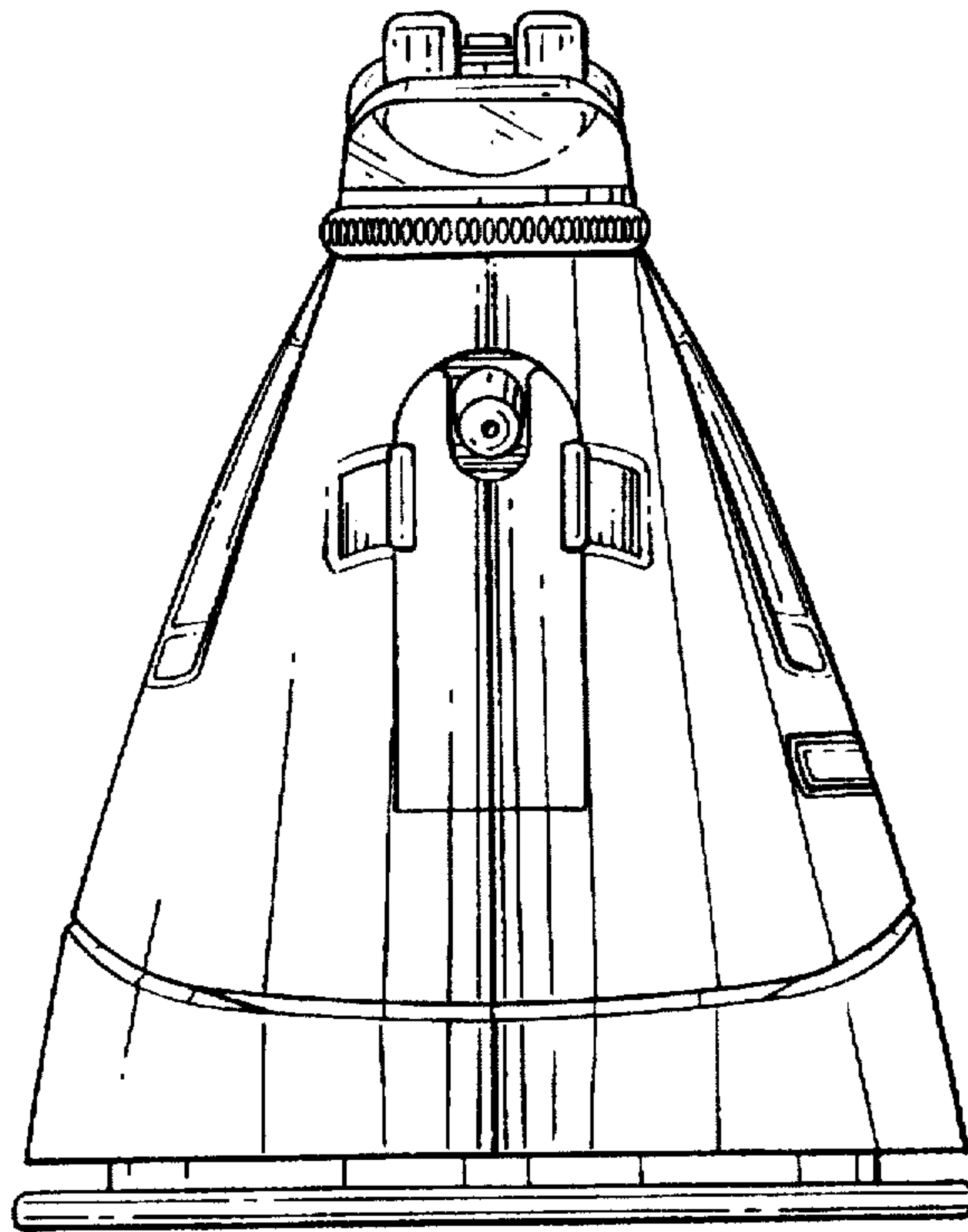

FIG. 2

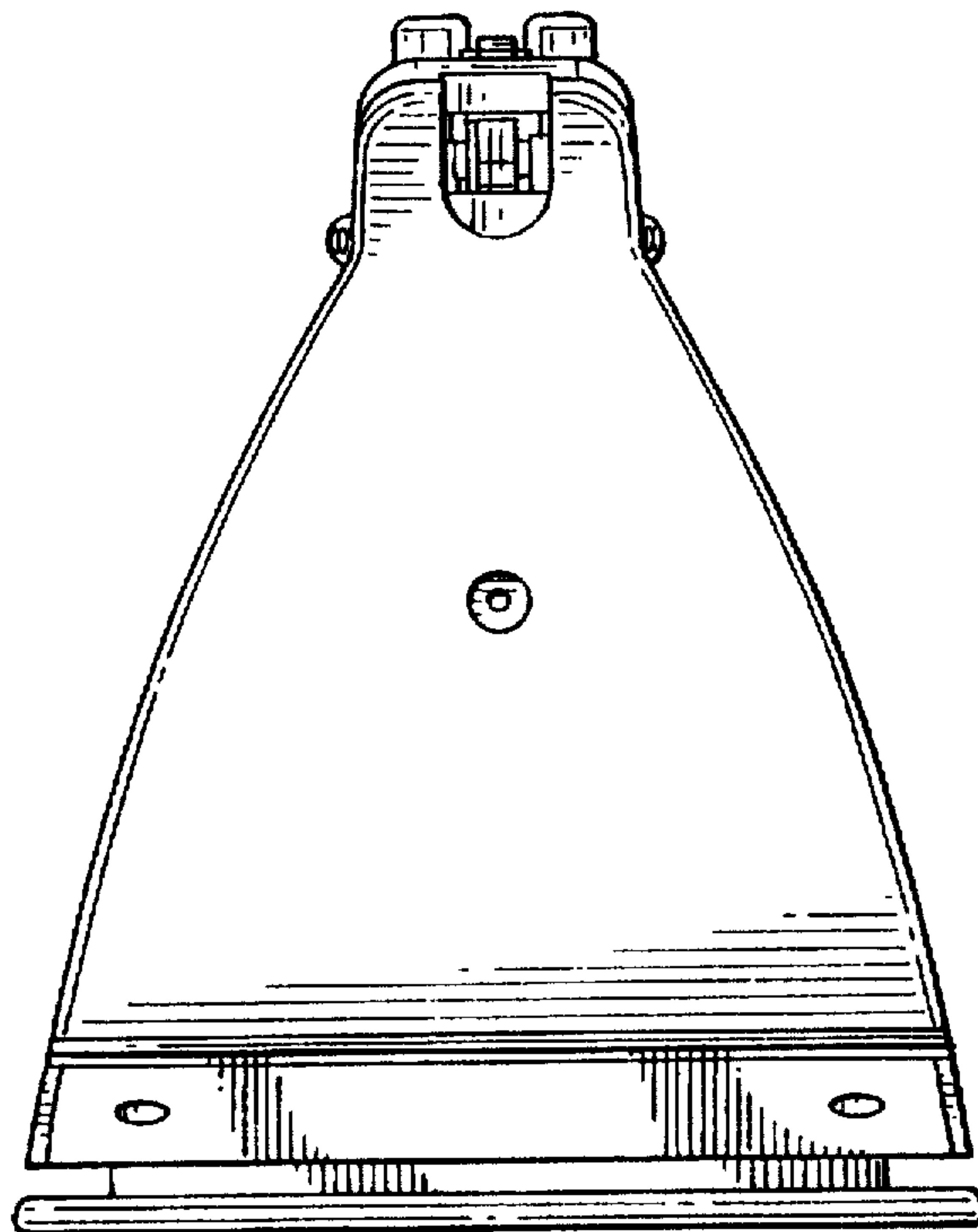

FIG. 3

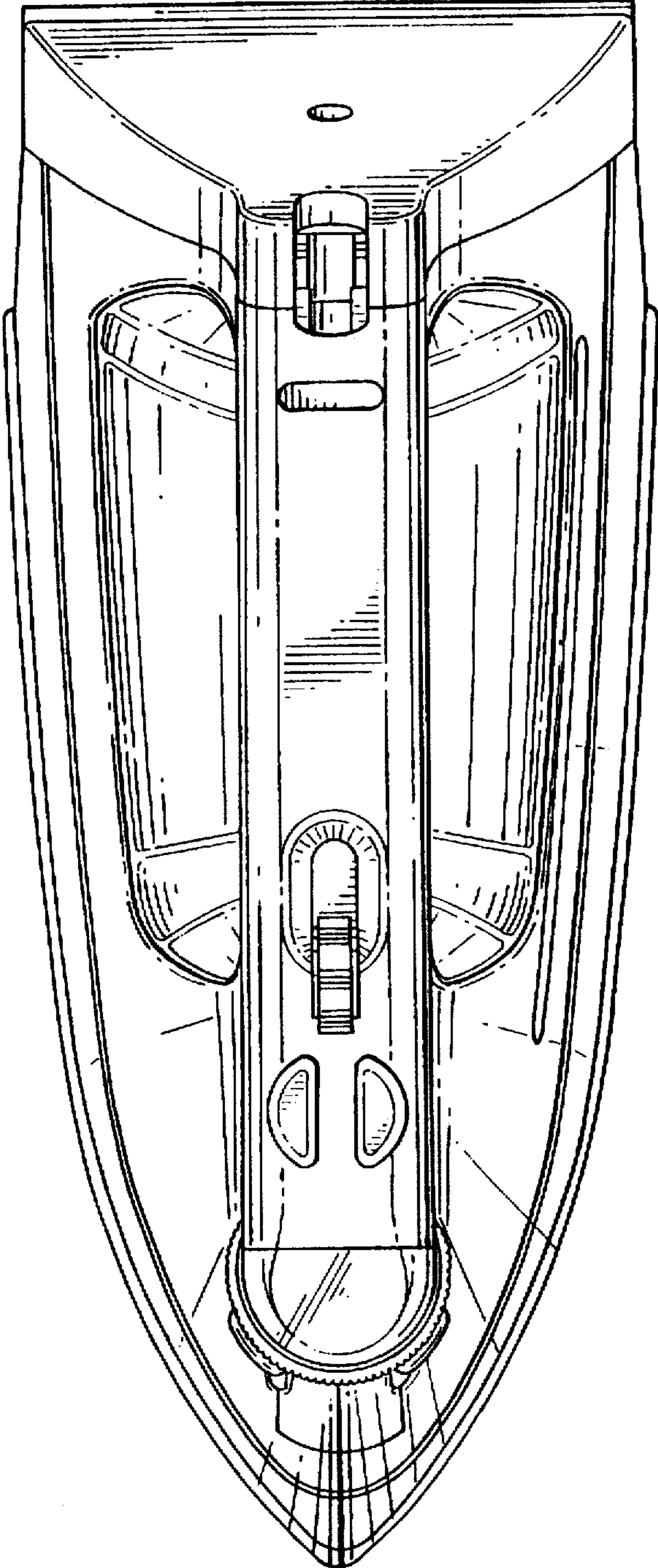

FIG. 4

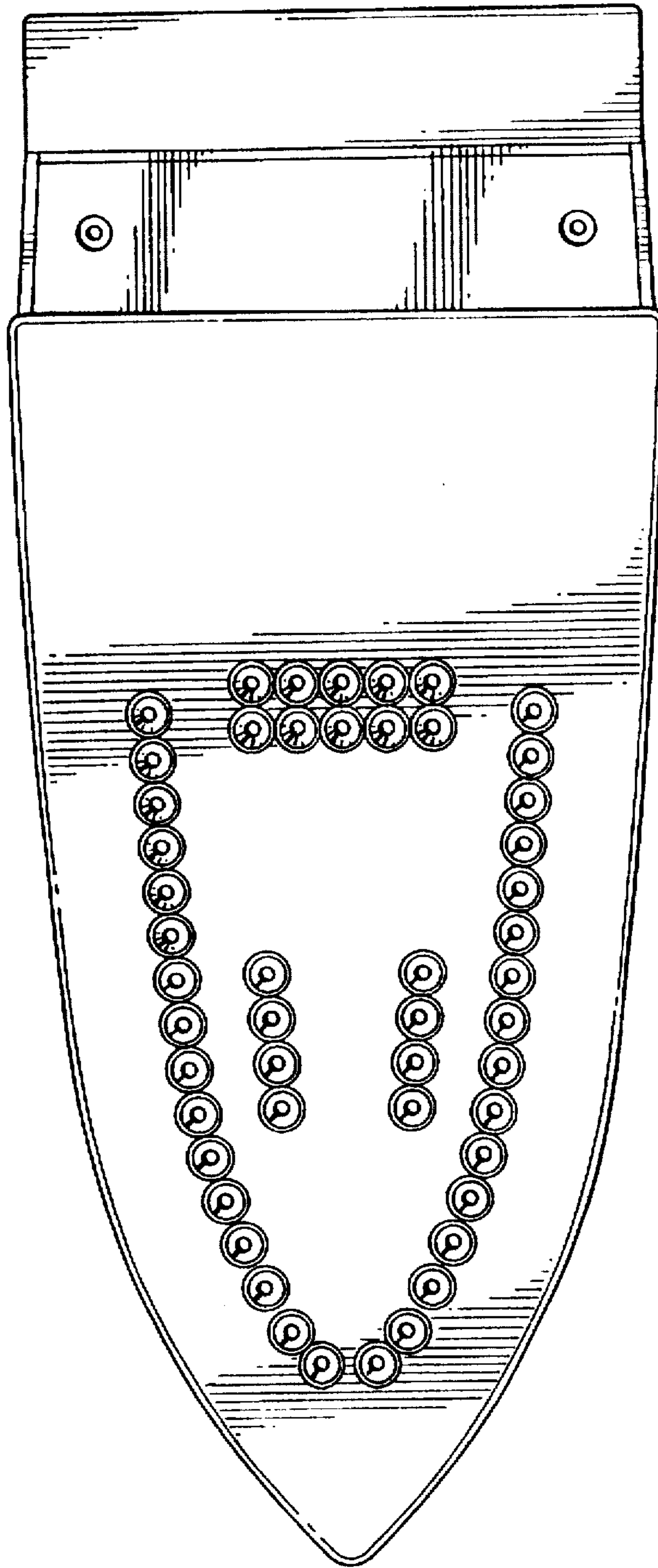

FIG. 5

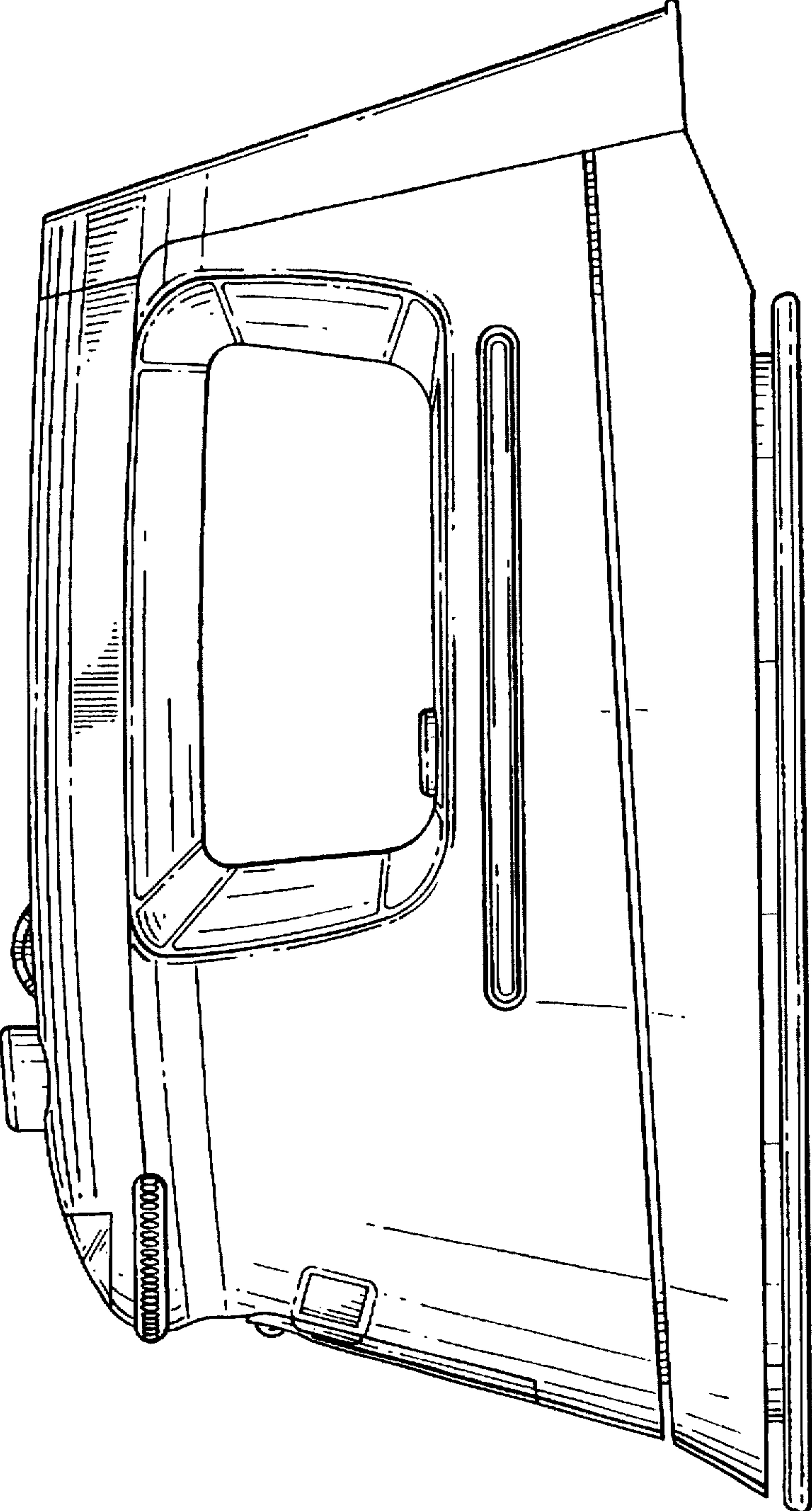

FIG. 6

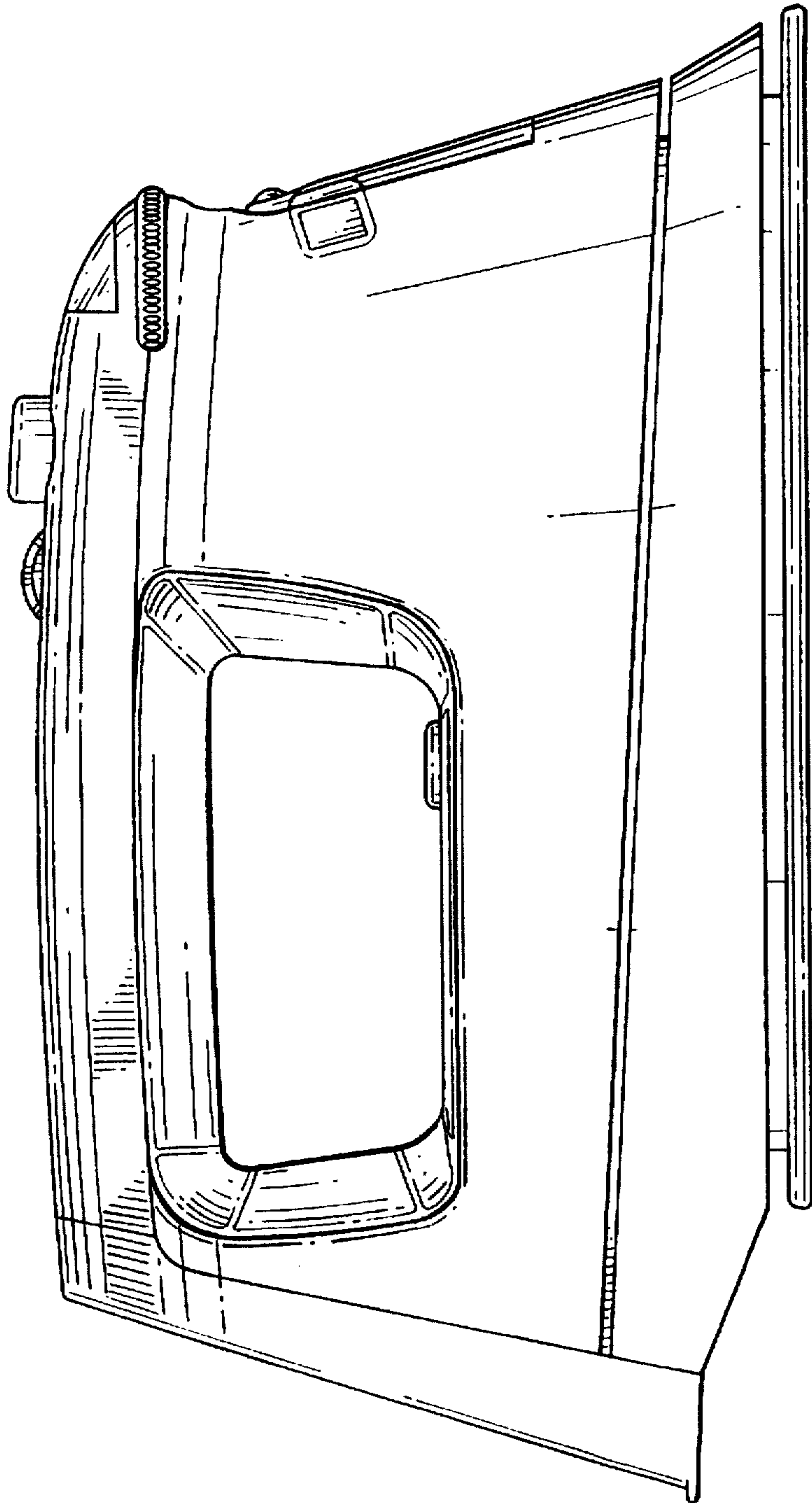

FIG. 7