

US00D393083S

# United States Patent [19] Caltrider

[11] Patent Number: Des. 393,083

[45] Date of Patent: \*\*Mar. 31, 1998

[54] WINDOW POUR MOLD

[75] Inventor: Larry John Caltrider, Des Moines, Iowa

[73] Assignee: M & G Manufacturing Co. Inc., Adel, Iowa

[\*\*] Term: 14 Years

[21] Appl. No.: 71,053

[22] Filed: May 17, 1997

[51] LOC (6) Cl. .... 25-99

[52] U.S. Cl. .... D25/199; D25/61; D25/124

[58] Field of Search ..... D25/124, 61, 164, D25/52, 199; 52/211, 587.1, 699, 208, 204.1, 206, 319, 322, 320, 326, 472, 656.1, 656.5; 249/39, 22, 177, 61

[56] **References Cited**

**U.S. PATENT DOCUMENTS**

D. 236,477	8/1975	Niendorf .....	D25/199
4,159,098	6/1979	Wong .....	249/61
4,430,831	2/1984	Kemp .....	249/39
4,589,624	5/1986	Jones .....	249/39

Primary Examiner—Doris Clark  
Attorney, Agent, or Firm—Robert A. Seemann

[57] **CLAIM**

The ornamental design for a window pour mold, as shown and described.

**DESCRIPTION**

FIG. 1 is a fragmentary perspective view of a window pour mold showing my new design;

FIG. 2 is a broken right end view of FIG. 1;

FIG. 3 is a fragmentary top view;

FIG. 4 is a fragmentary rear view;

FIG. 5 is a fragmentary bottom view;

FIG. 6 is a fragmentary front view; and,

FIG. 7 is a front view of four mitered sections of the window pour mold in place in a section of concrete wall. The view is from slightly below and to the left of center. The broken line portion of FIG. 7 is for illustrative purposes only and forms no part of the claimed design.

The window pour mold is broken on the end to indicate indeterminate length.

**1 Claim, 4 Drawing Sheets**

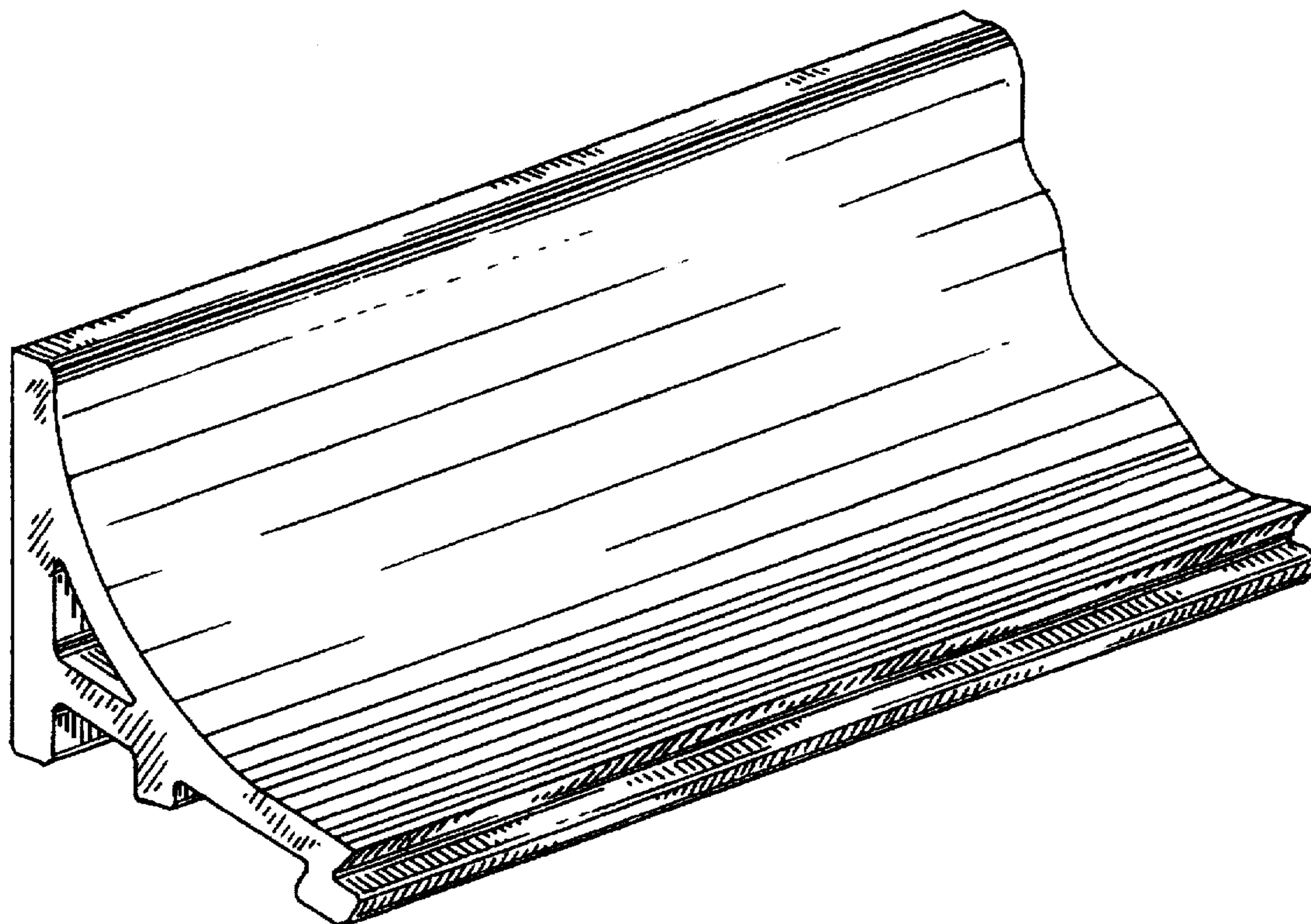

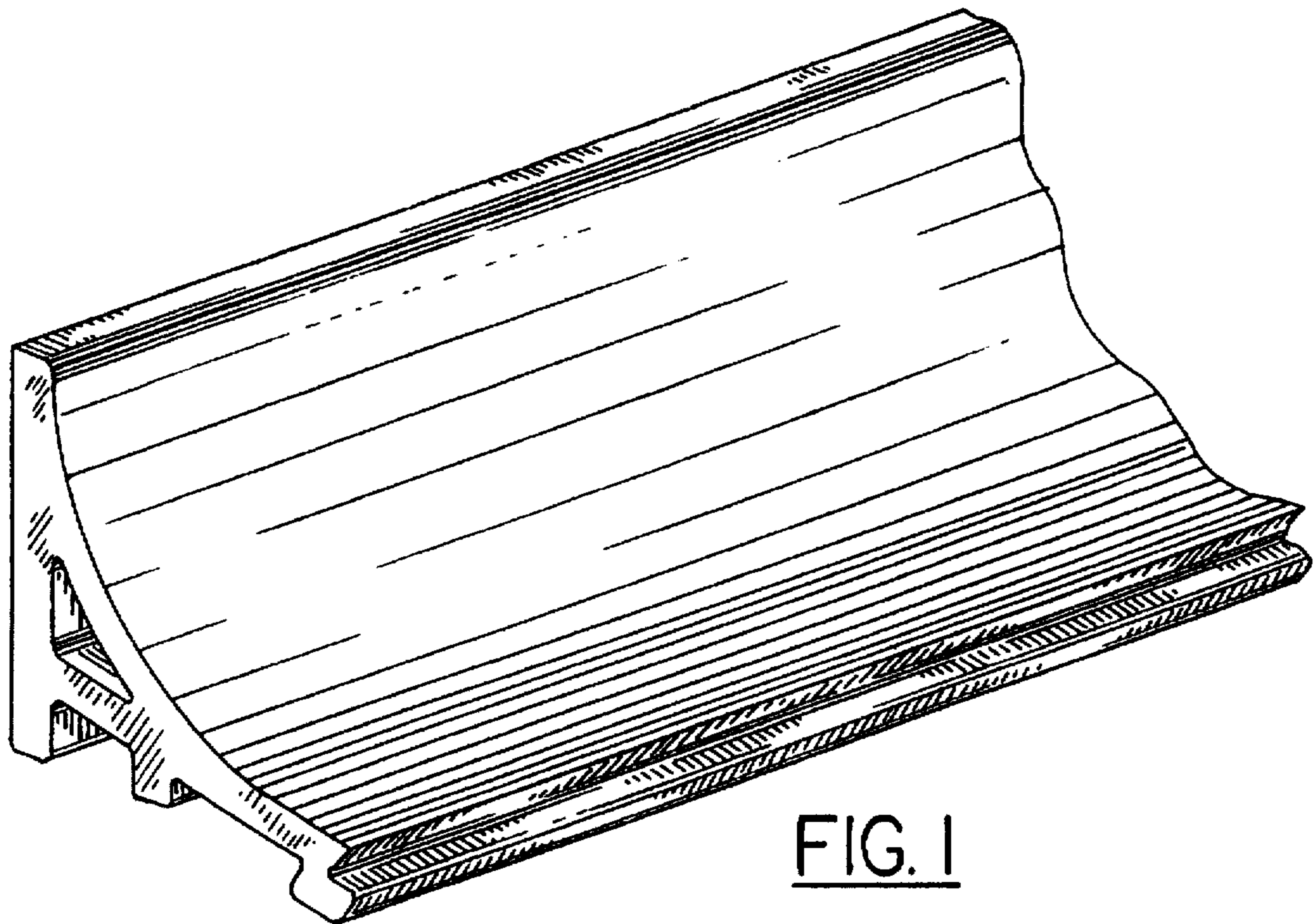

FIG. 1

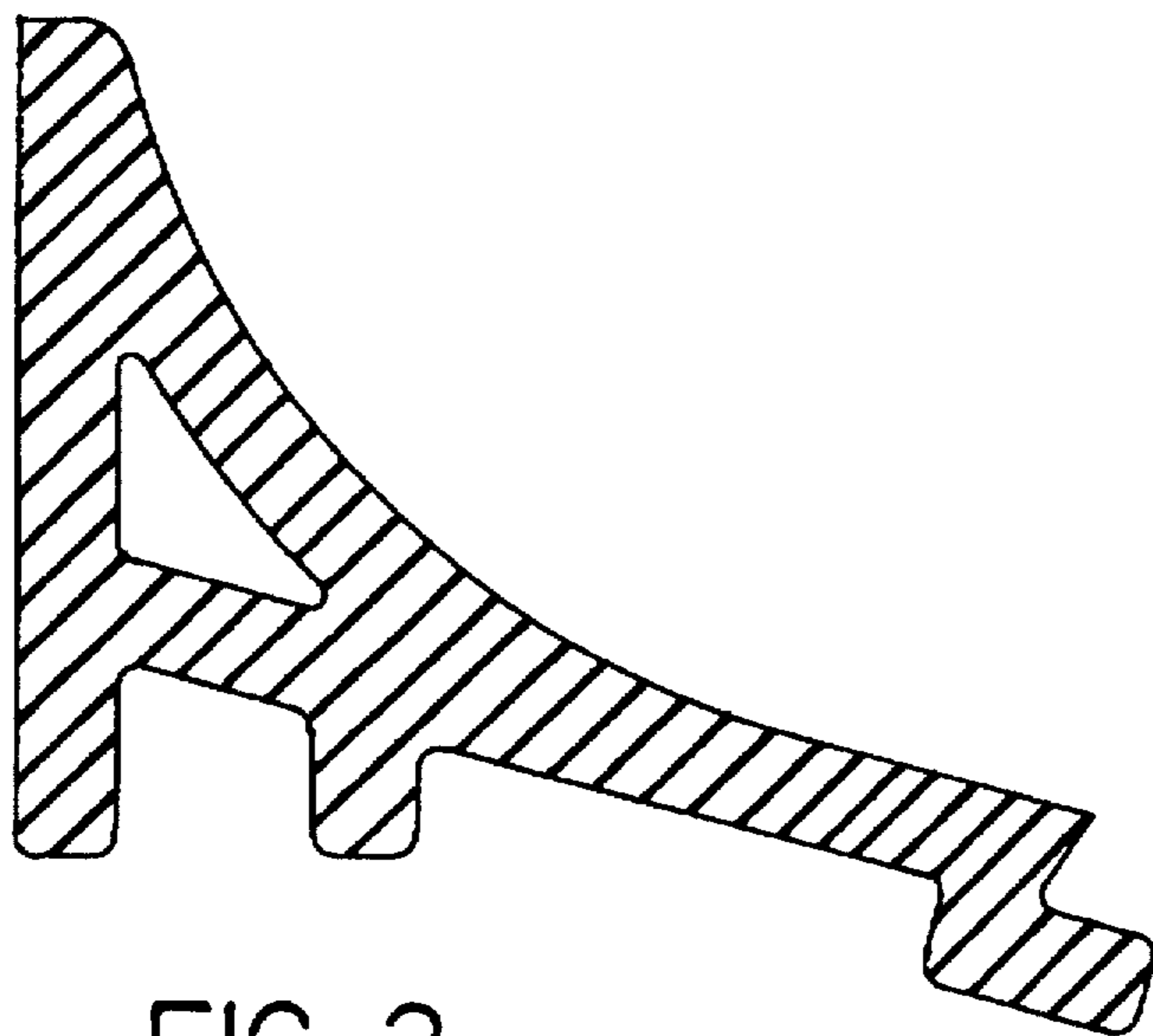

FIG. 2

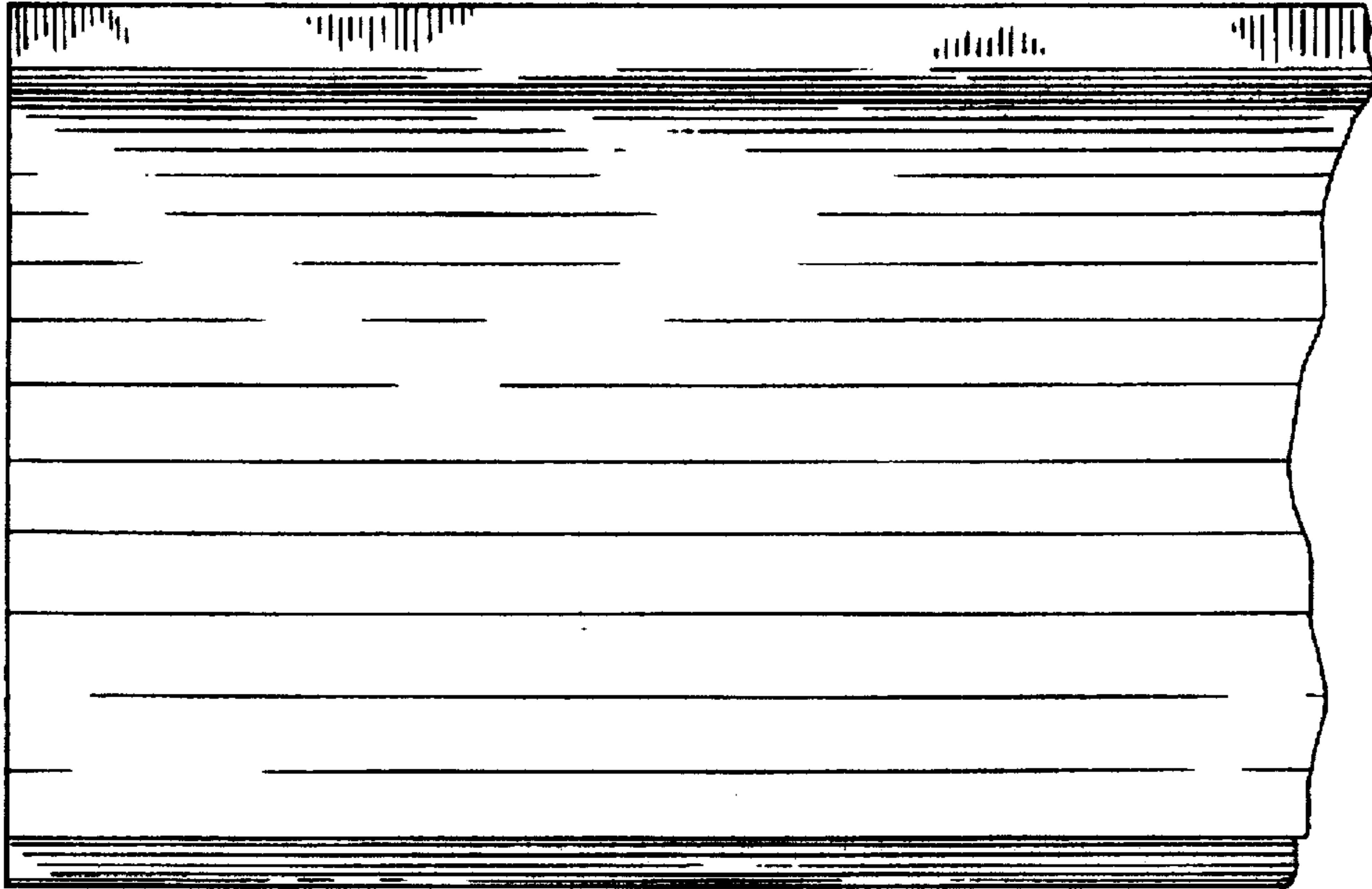

FIG. 3



FIG. 4

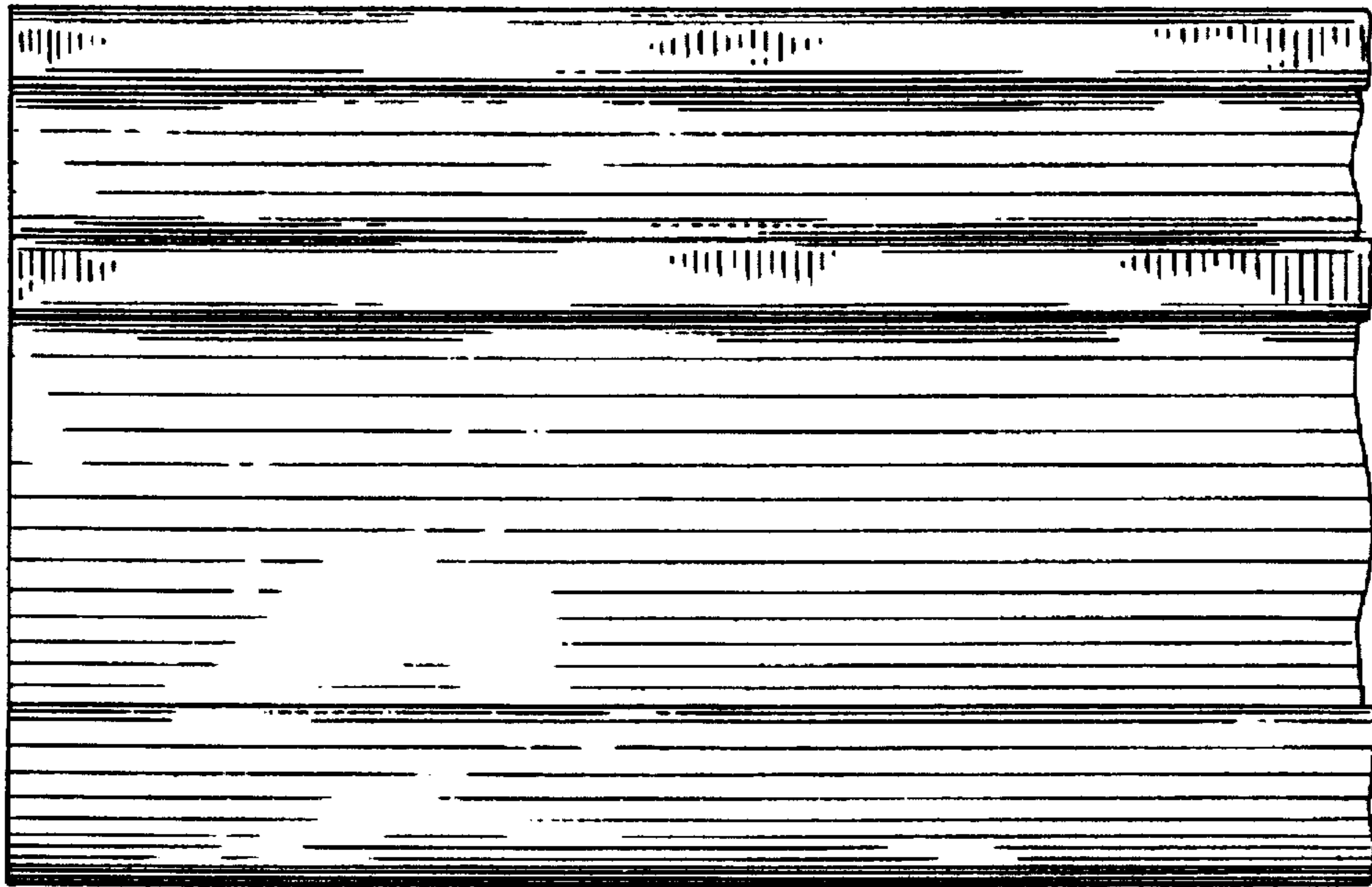

FIG. 5

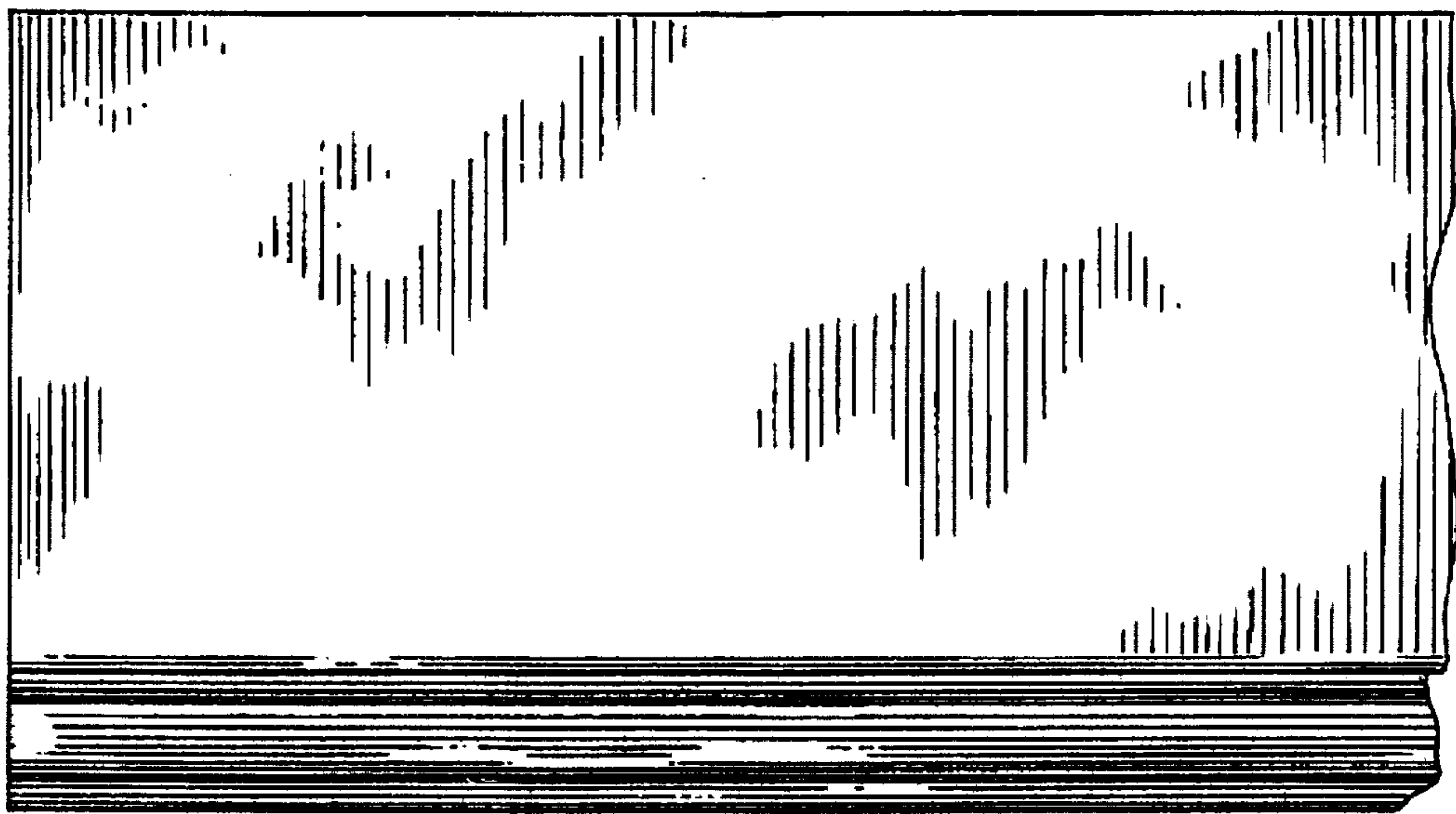

FIG. 6

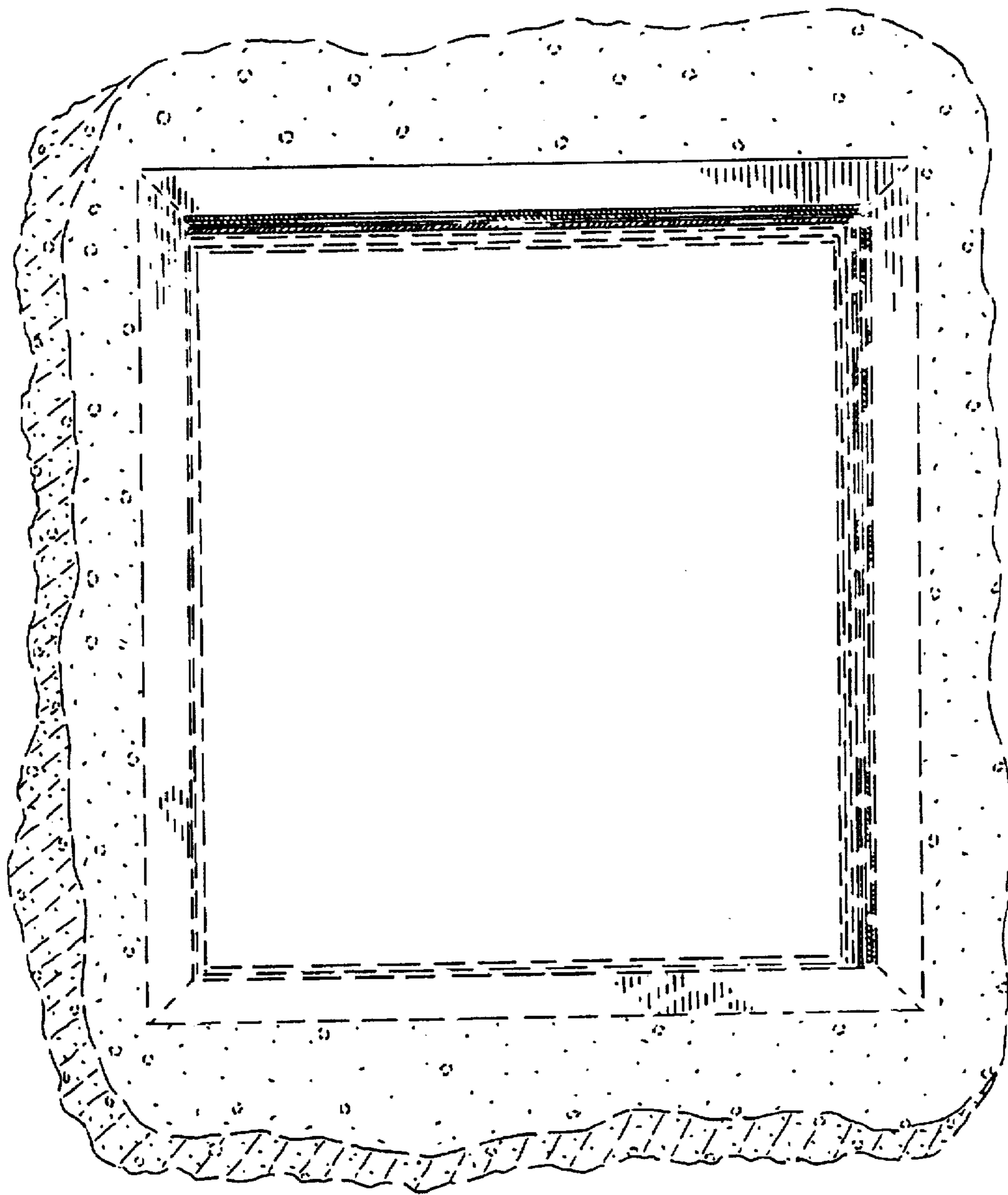

FIG. 7

UNITED STATES PATENT AND TRADEMARK OFFICE  
**CERTIFICATE OF CORRECTION**

PATENT NO. : Des. 393,083  
DATED : March 31, 1998  
INVENTOR(S) : Larry John Caltrider

Page 1 of 1

It is certified that error appears in the above-identified patent and that said Letters Patent is hereby corrected as shown below:

Title page,

Item [73], Assignee, change the assignee's name from "M & G Manufacturing Co. Inc." to -- **M & G Manufacturing Company** --

Signed and Sealed this

Fifth Day of August, 2003

A handwritten signature in black ink, appearing to read "James E. Rogan", with a horizontal line drawn underneath it.

JAMES E. ROGAN  
*Director of the United States Patent and Trademark Office*