



US00D393032S

United States Patent [19]

Stone et al.

[11] Patent Number: Des. 393,032

[45] Date of Patent: **Mar. 31, 1998

[54] GOLF CLUB HEAD

[75] Inventors: Daniel J. Stone, Long Beach; Stephen C. Chien, Irvine, both of Calif.; Harold Meyer, Voreppe, France

[73] Assignee: Roger Cleveland Golf Company, Inc., Cypress, Calif.

[**] Term: 14 Years

[21] Appl. No.: 65,223

[22] Filed: Jan. 24, 1997

[51] LOC (6) Cl. 21-02

[52] U.S. Cl. D21/217

[58] Field of Search D21/217-219, D21/214, 220; 473/251-256, 324, 327, 328, 340, 341

[56] References Cited

U.S. PATENT DOCUMENTS

D. 352,324	11/1994	Sicaeros	D21/214
4,248,430	2/1981	Kepler	473/340
4,930,783	6/1990	Antonious	473/340

OTHER PUBLICATIONS

Golf Day; p. 12; Bullett driver, upper right of page, Apr. 1995.

Primary Examiner—Ted Shooman

Assistant Examiner—Mitchell I. Siegel

Attorney, Agent, or Firm—Parkhurst & Wendel, L.L.P.

[57] CLAIM

The ornamental design for a golf club head, as shown and described.

DESCRIPTION

FIG. 1 is an elevated bottom perspective view of a golf club head showing our new design; FIG. 2 is a back view thereof; FIG. 3 is a front view thereof; FIG. 4 is a top view thereof; FIG. 5 is a bottom view thereof; FIG. 6 is a left view thereof; and, FIG. 7 is a right view thereof.

The broken line showing of a fragmented shaft is for illustrative purposes only and forms no part of the claimed design.

1 Claim, 2 Drawing Sheets

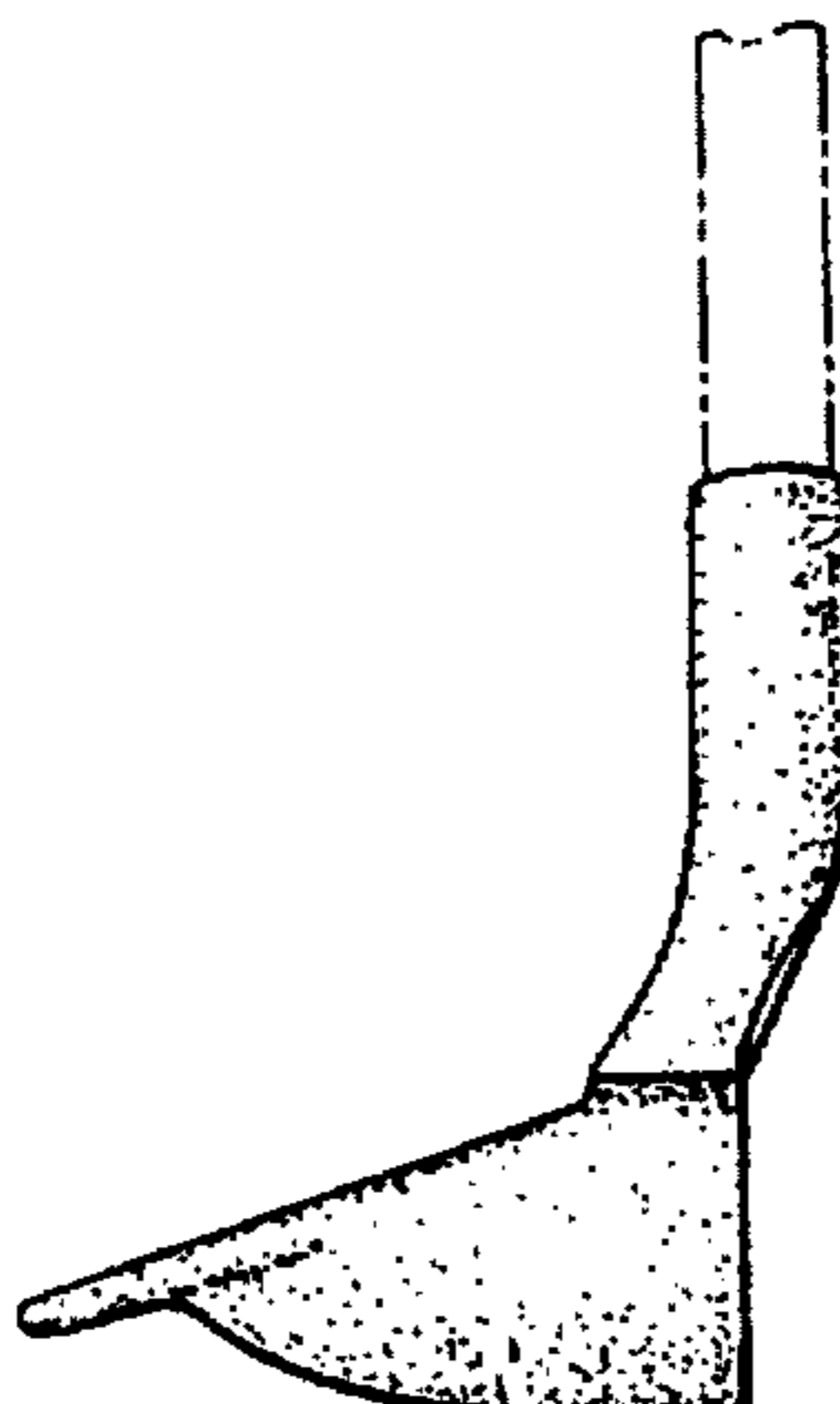
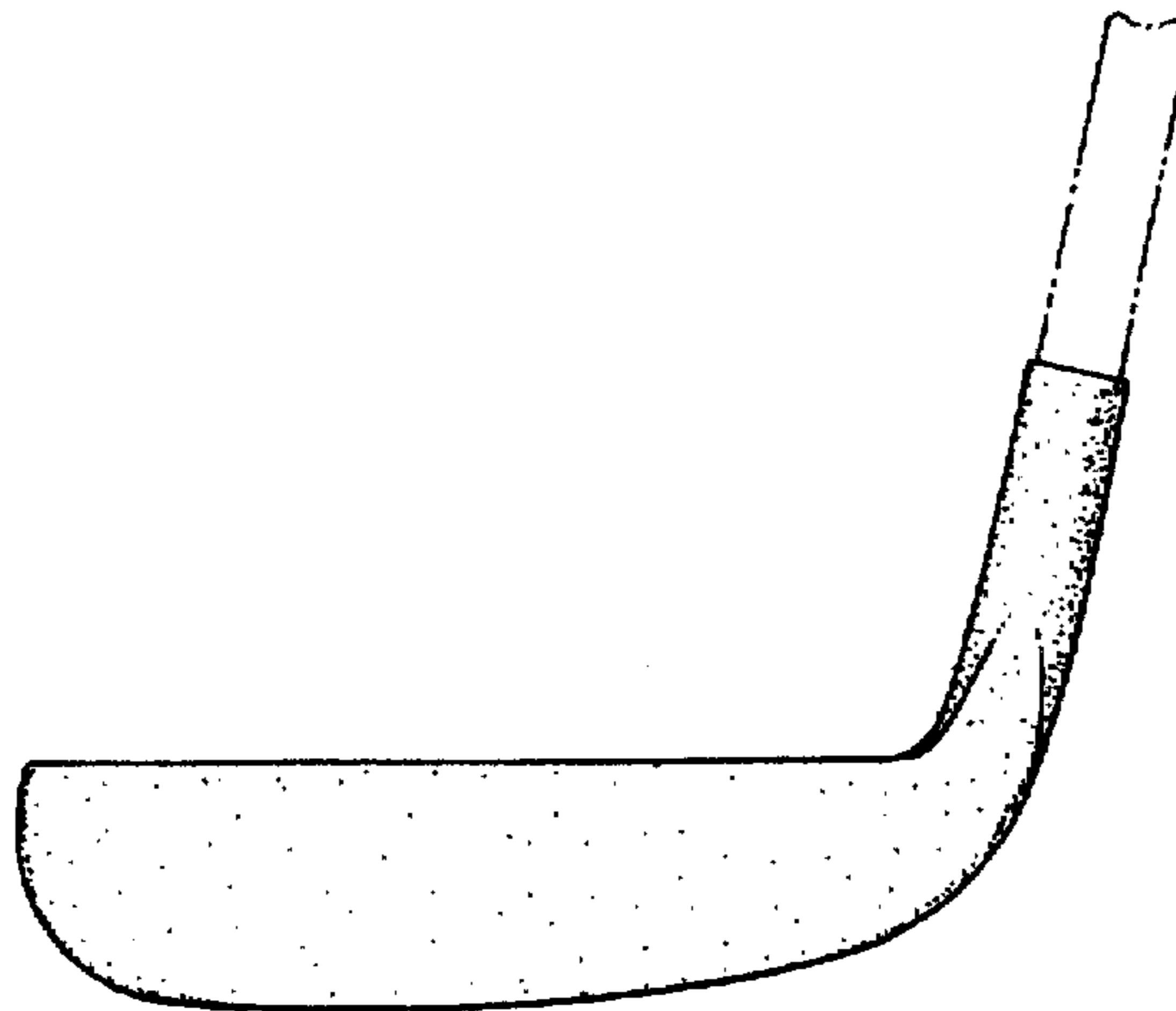

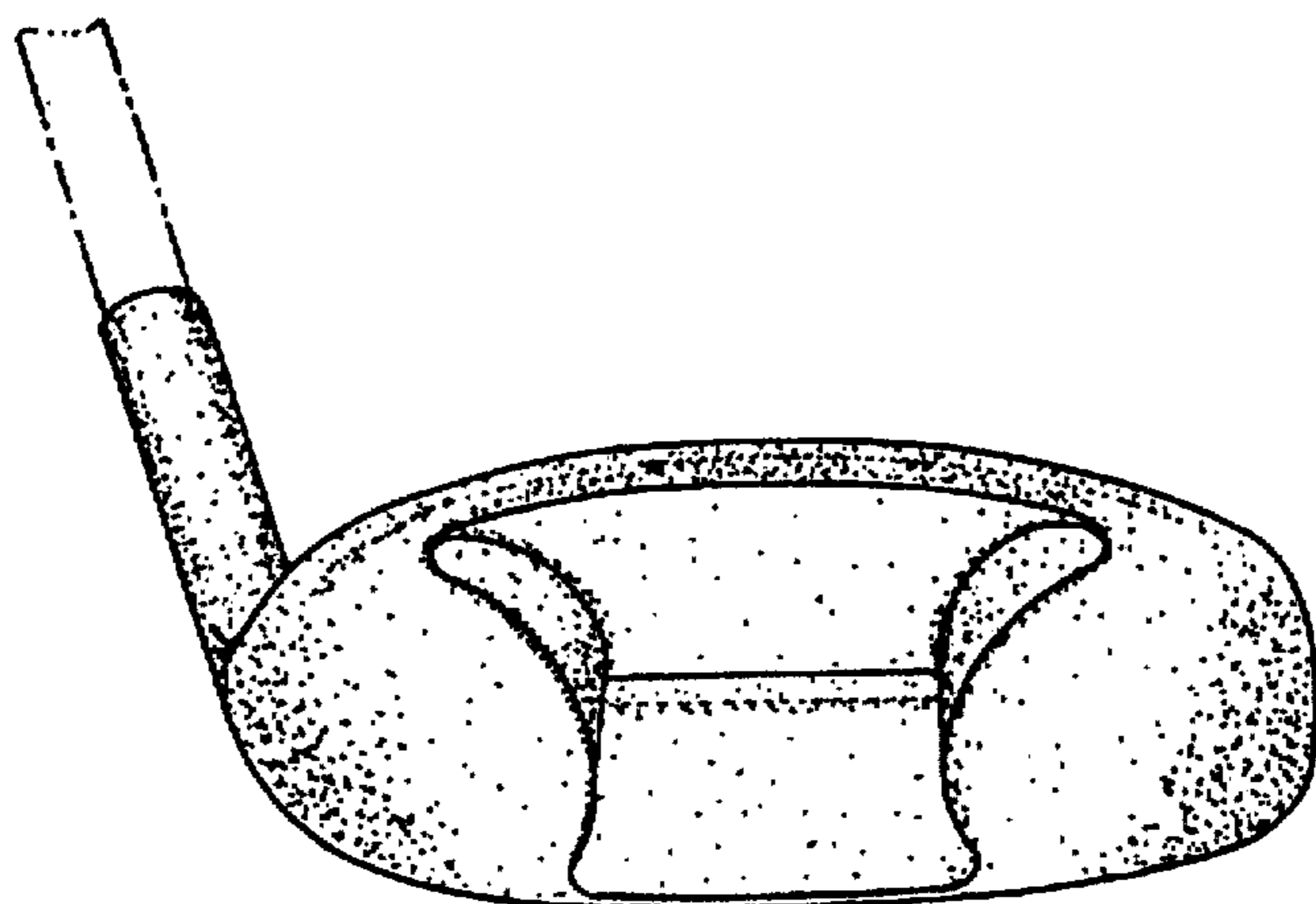

Figure 1

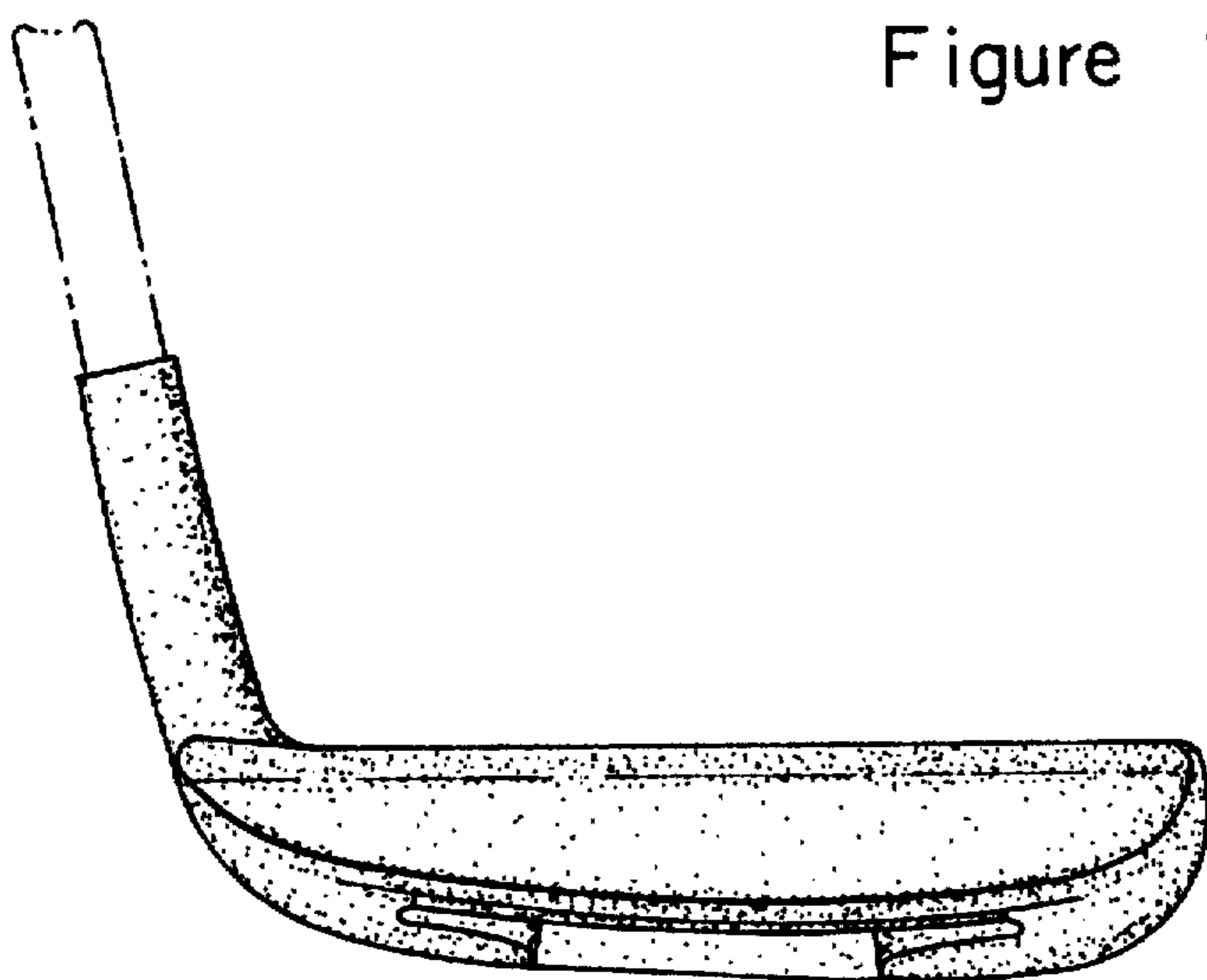

Figure 2

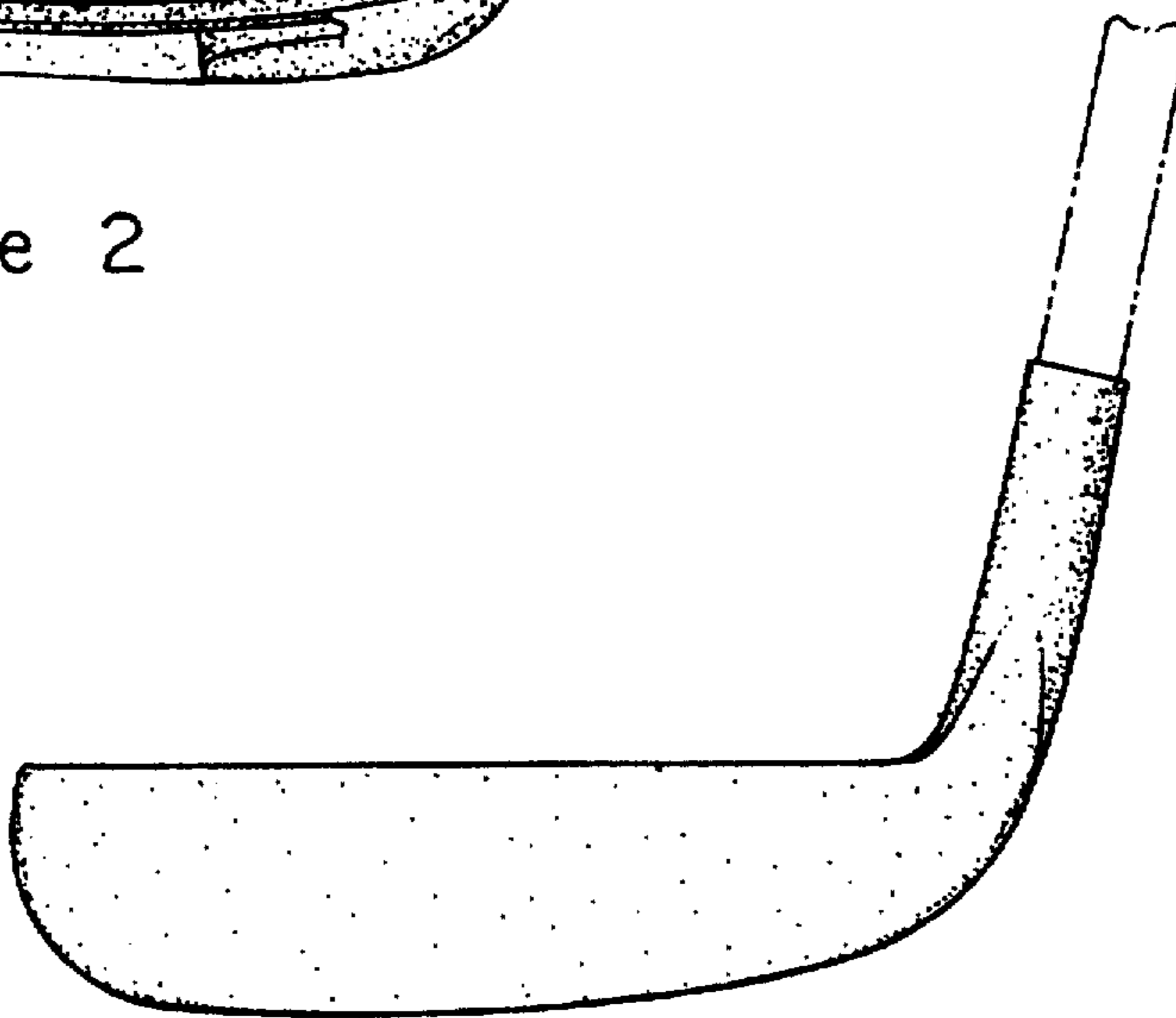

Figure 3

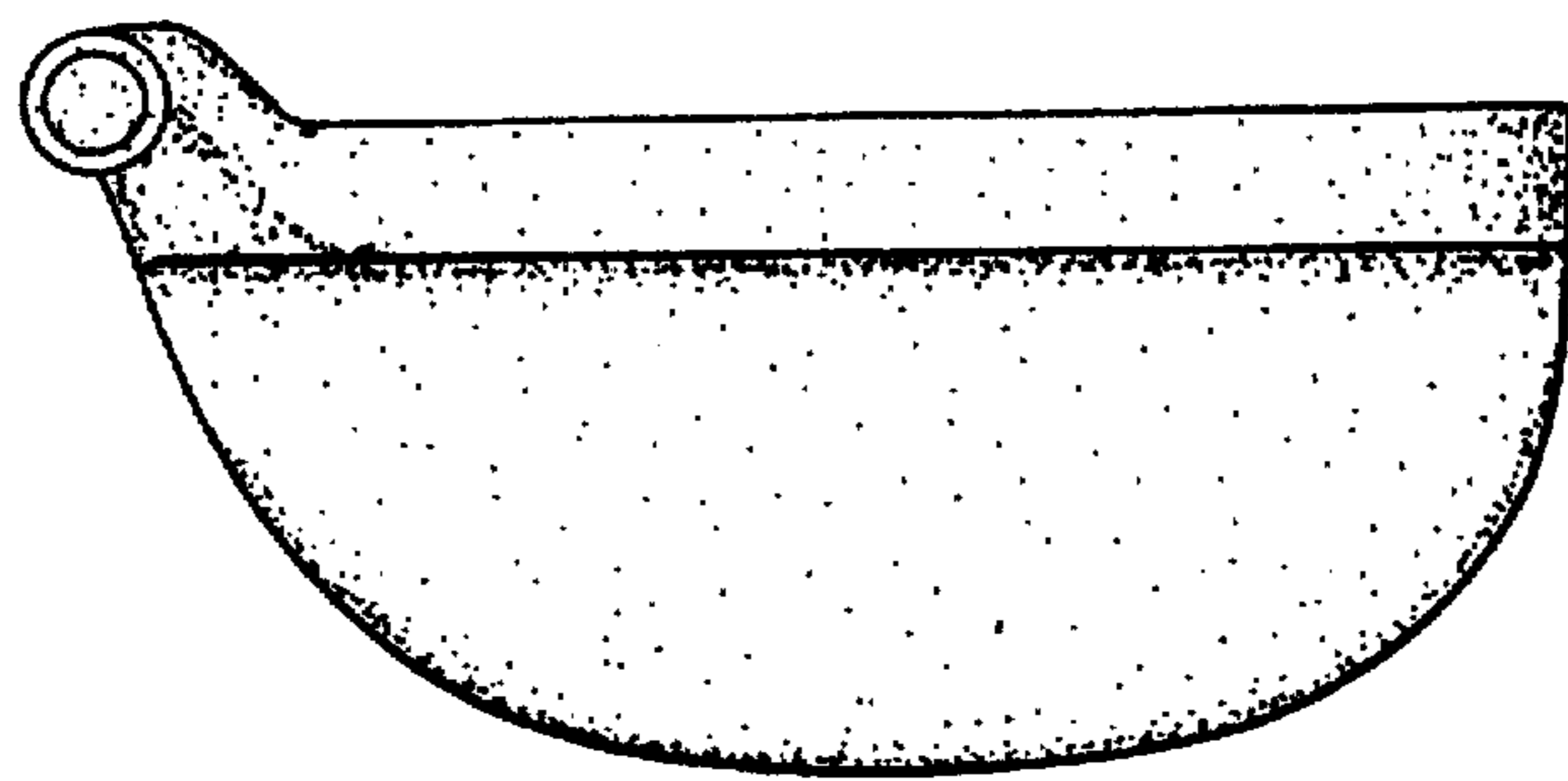

Figure 4

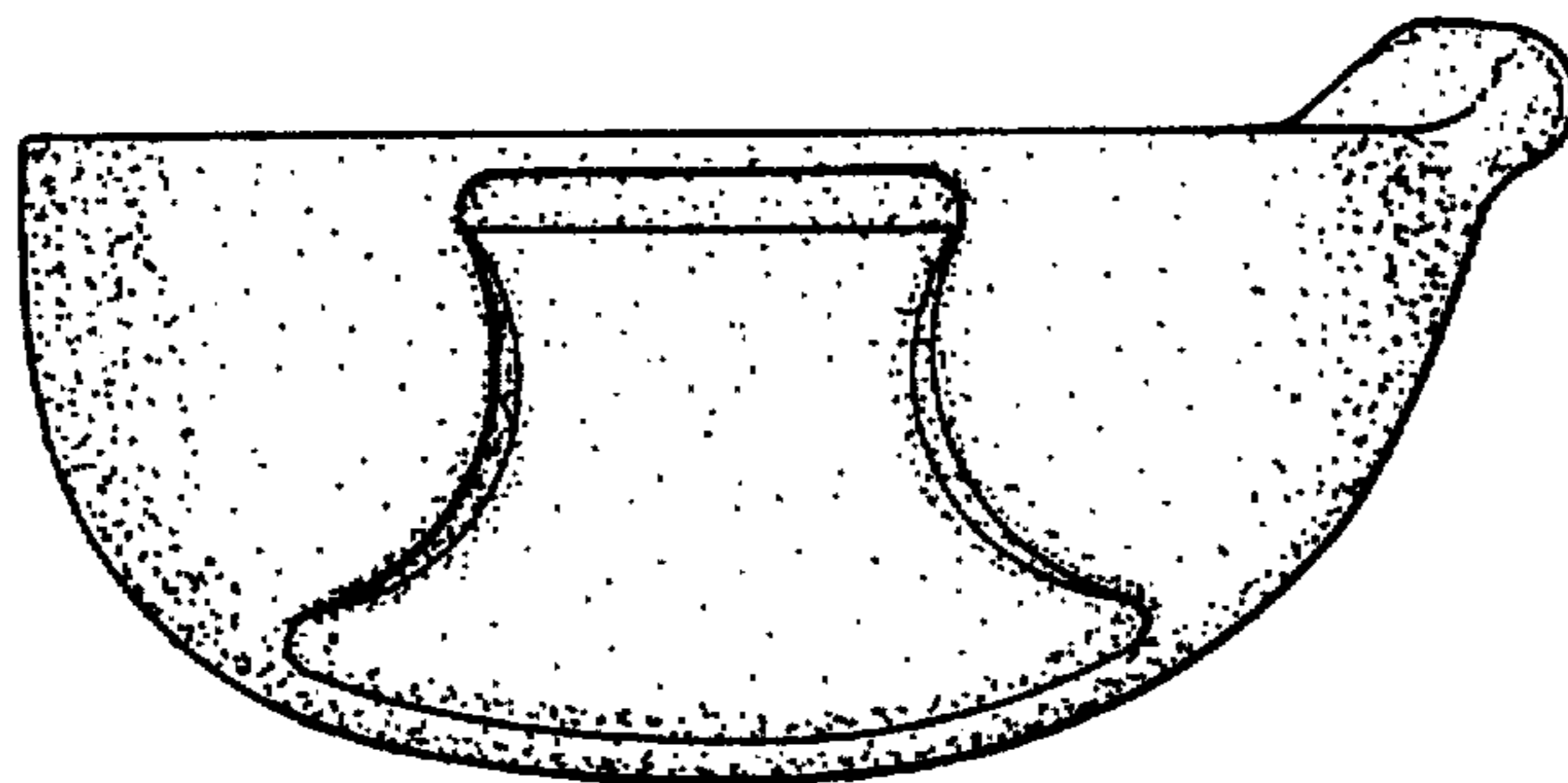

Figure 5

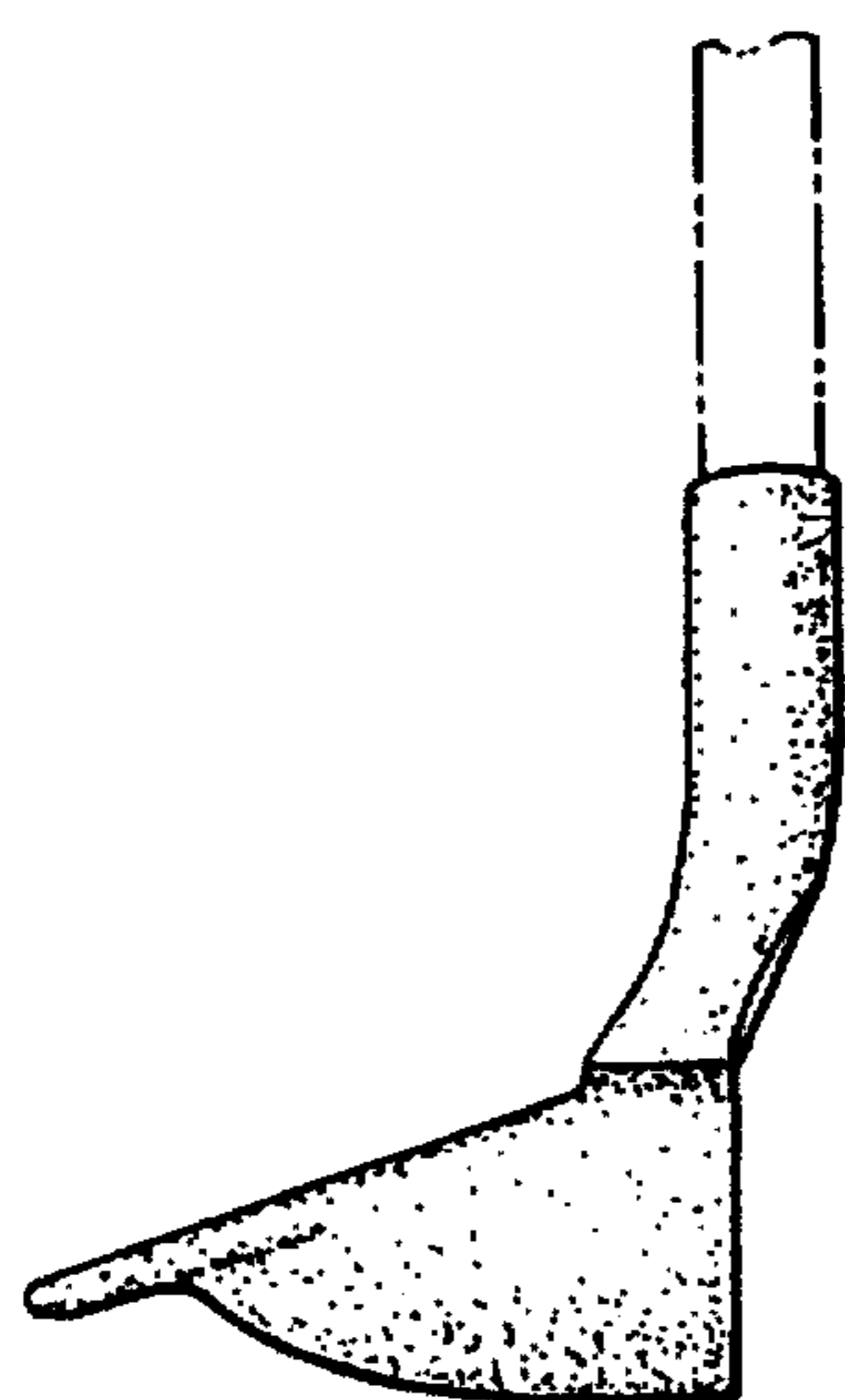

Figure 6

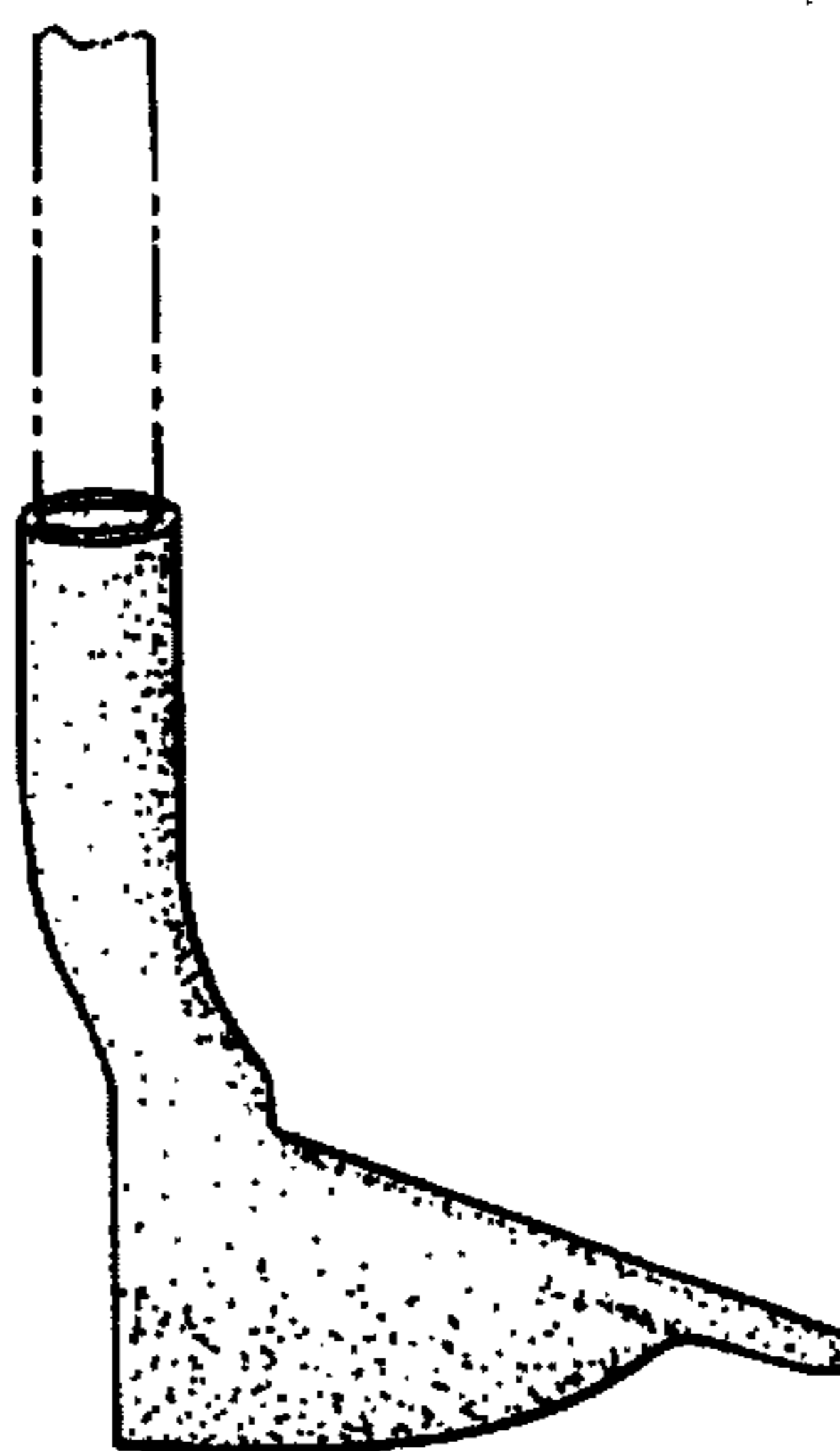

Figure 7