



US00D392986S

United States Patent [19]
Katou

[11] **Patent Number: Des. 392,986**
[45] **Date of Patent: **Mar. 31, 1998**

[54] **BINOCULARS**

[75] **Inventor: Takaharu Katou, Chino, Japan**
[73] **Assignee: Nikon Corporation, Tokyo, Japan**
[**] **Term: 14 Years**

D. 299,724	2/1989	Aoki	D16/133
D. 307,154	4/1990	Shishikura	D16/133
D. 346,175	4/1994	Chan	D16/133
D. 347,649	6/1994	Hashimoto et al.	D16/133
D. 359,972	7/1995	Takahashi	D16/133
D. 361,777	8/1995	Akabane et al.	D16/133
4,325,602	4/1982	Lange	359/408
5,231,535	7/1993	Peters et al.	359/414

[21] **Appl. No.: 70,965**
[22] **Filed: May 20, 1997**

Primary Examiner—Paula A. Mortimer
Attorney, Agent, or Firm—Oliff & Berridge, PLC

[30] **Foreign Application Priority Data**

Dec. 24, 1996 [JP] Japan 8-38927

[57] **CLAIM**

The ornamental design for binoculars, as shown.

[51] **LOC (6) Cl. 16-06**
[52] **U.S. Cl. D16/133**
[58] **Field of Search D16/130, 132,**
D16/133; 359/407, 408, 409, 410, 411,
412, 413, 414, 415, 416, 417, 418

DESCRIPTION

FIG. 1 is a front elevational view of binoculars showing my new design;
FIG. 2 is a rear elevational view thereof;
FIG. 3 is a top plan elevational view thereof;
FIG. 4 is a bottom plan elevational view thereof;
FIG. 5 is a left side elevational view thereof;
FIG. 6 is a right side elevational view thereof;
FIG. 7 is a front perspective view thereof; and,
FIG. 8 is a front perspective view of the binocular in a collapsed position.

[56] **References Cited**

U.S. PATENT DOCUMENTS

D. 223,298	4/1972	Senda	D16/133
D. 272,362	1/1984	Hengst et al.	D16/133
D. 287,369	12/1986	Janke et al.	D16/133
D. 292,412	10/1987	Janke et al.	D16/133

1 Claim, 4 Drawing Sheets

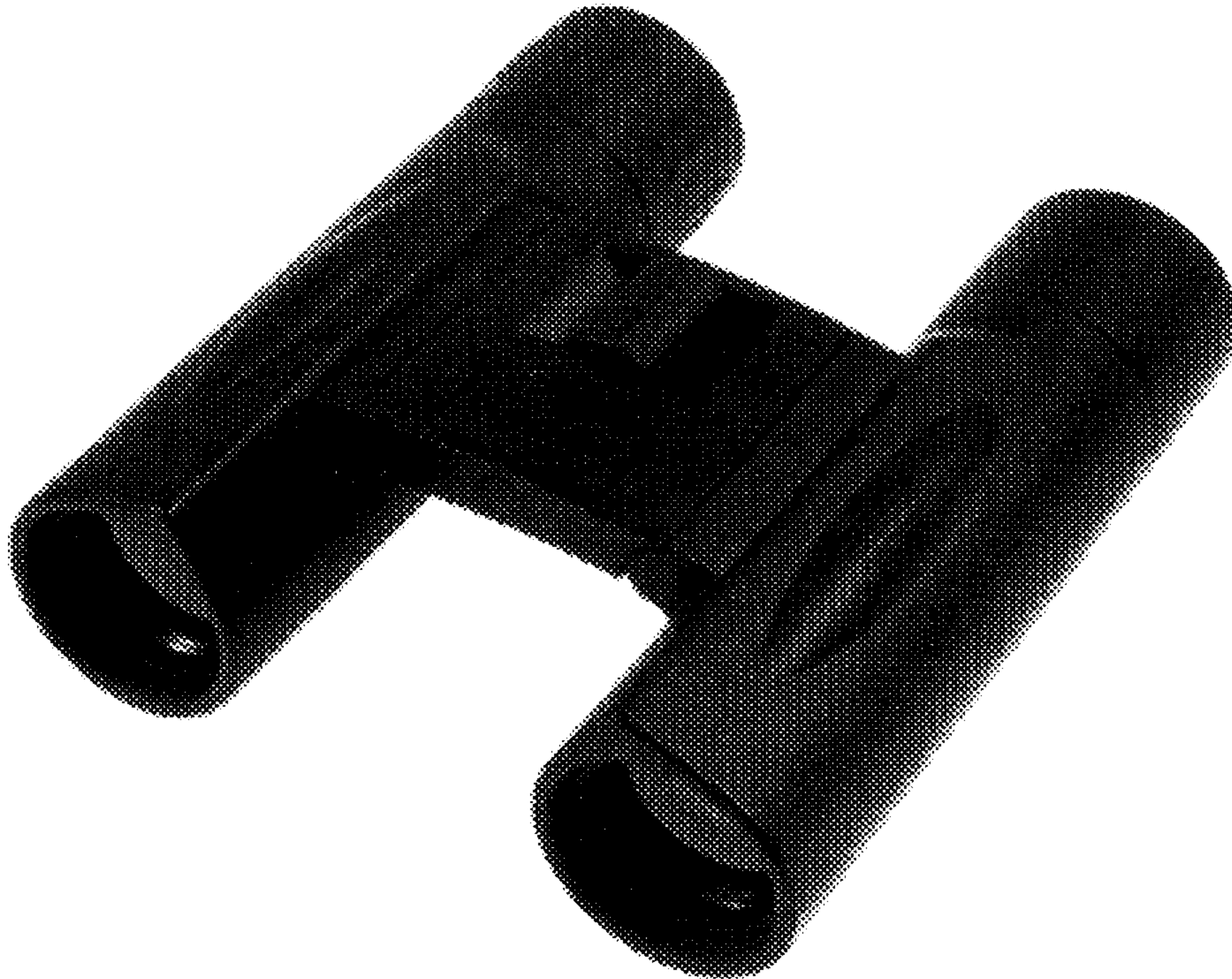

FIG. 1

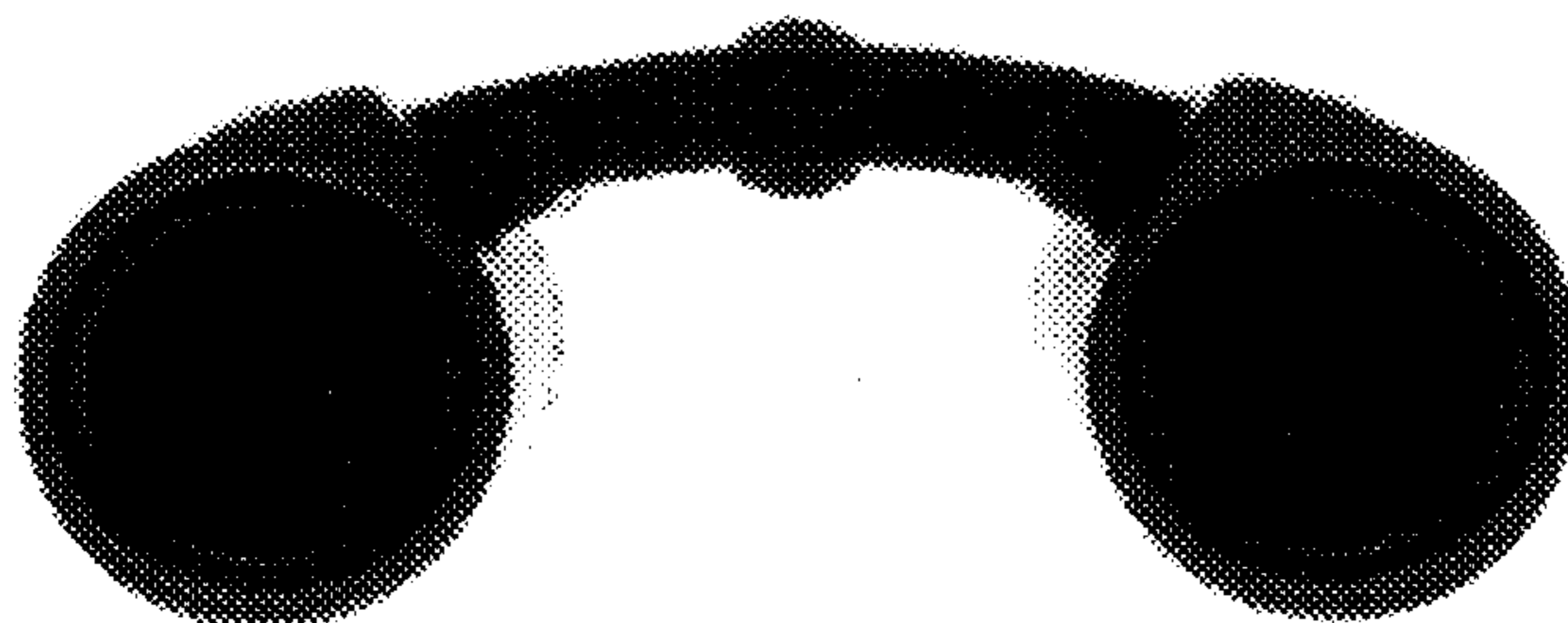

FIG. 2

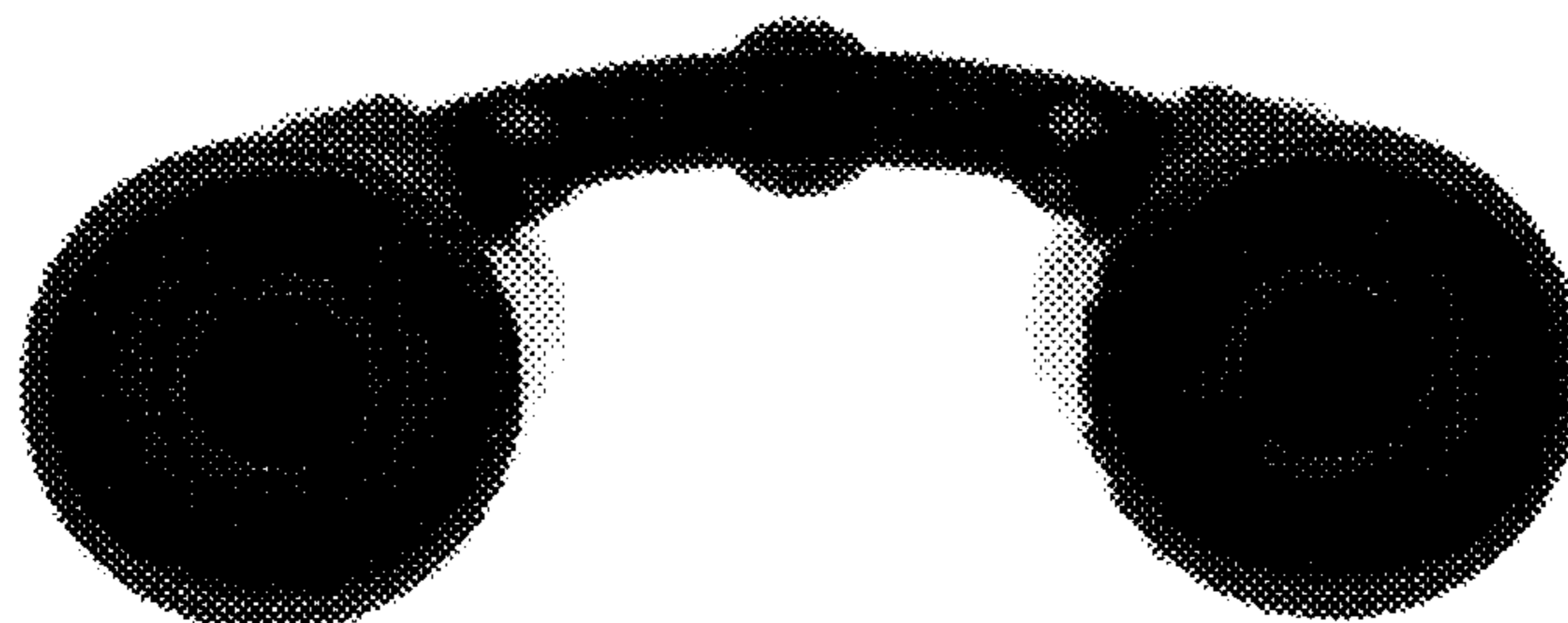

FIG. 3

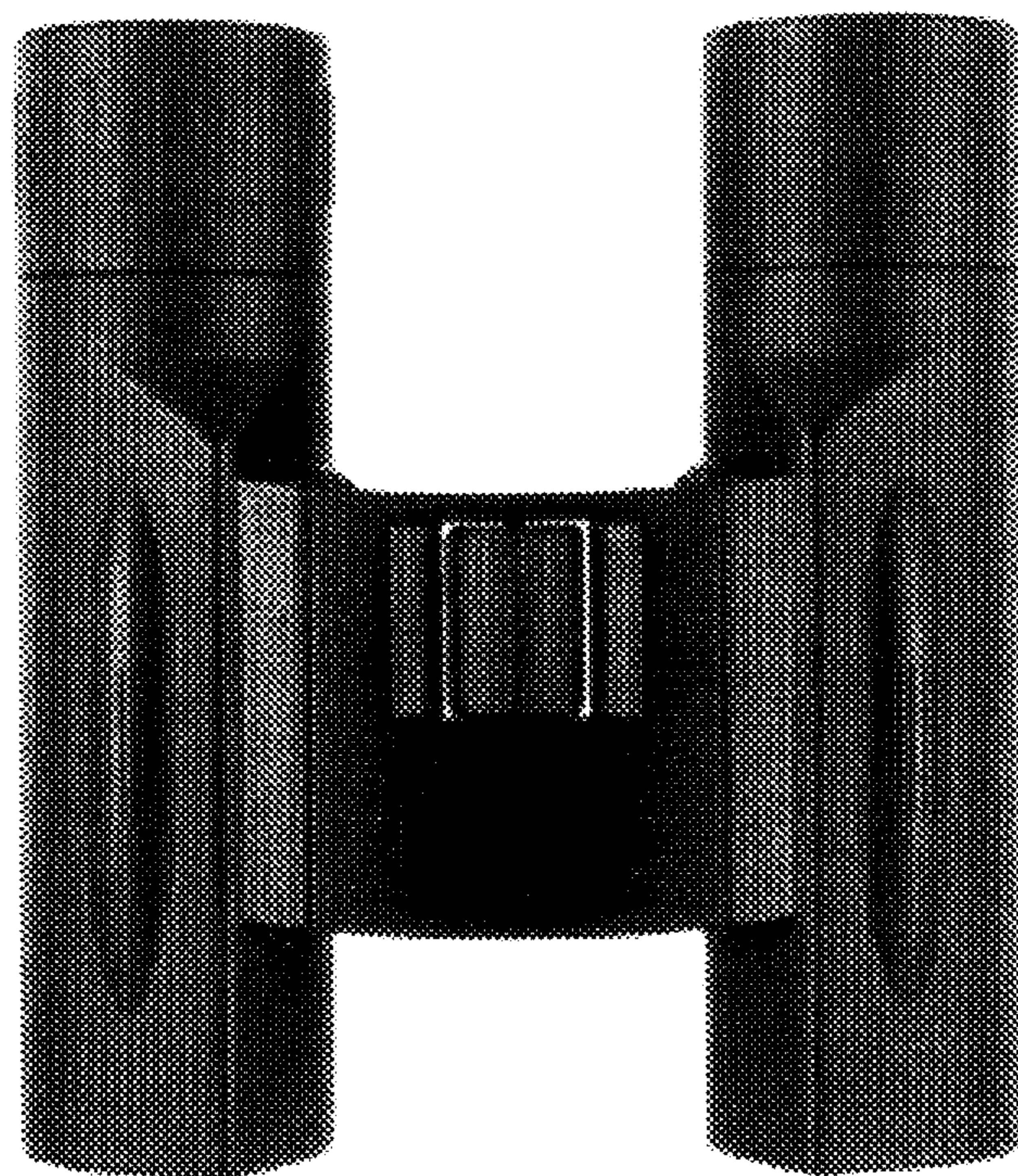

FIG. 4

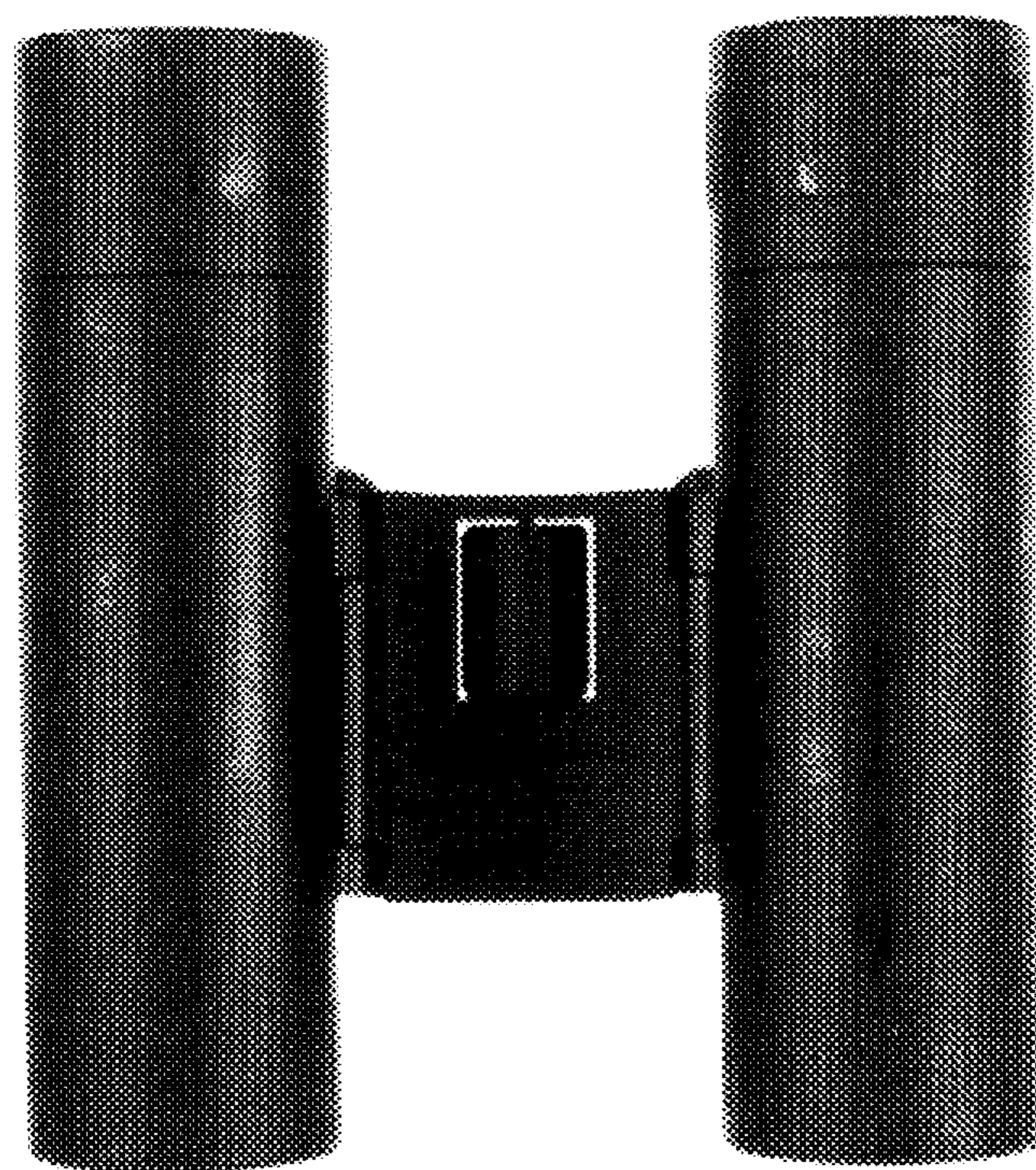

FIG. 5

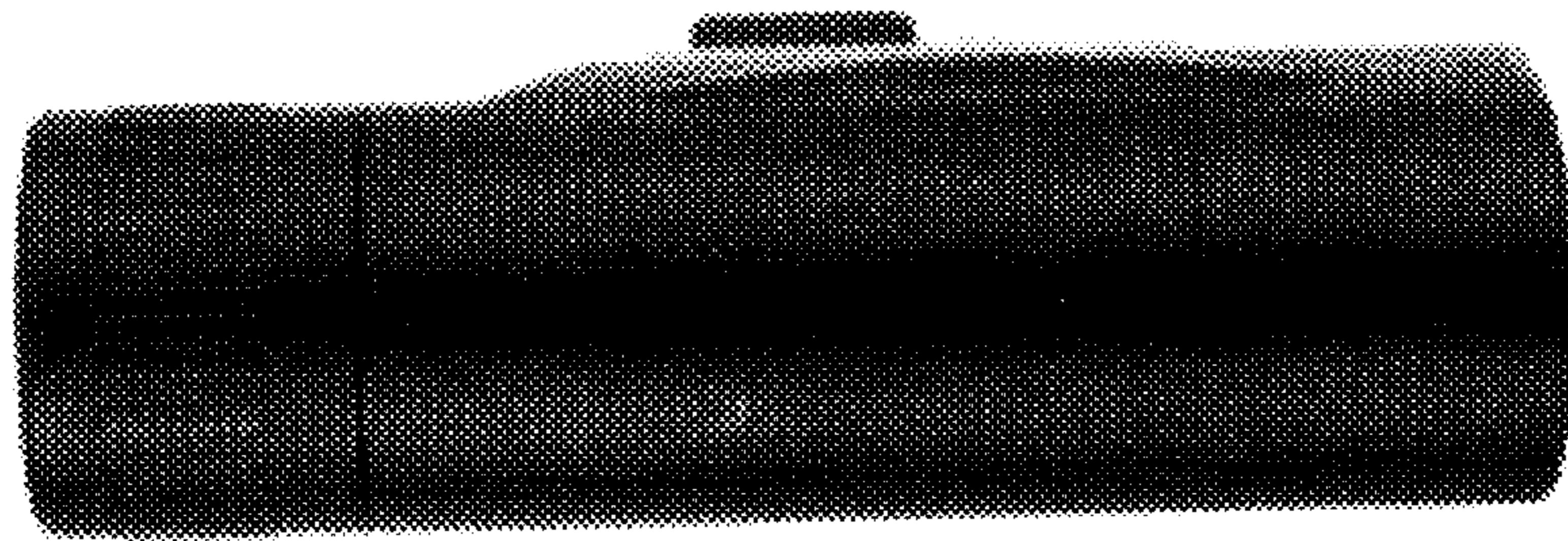

FIG. 6

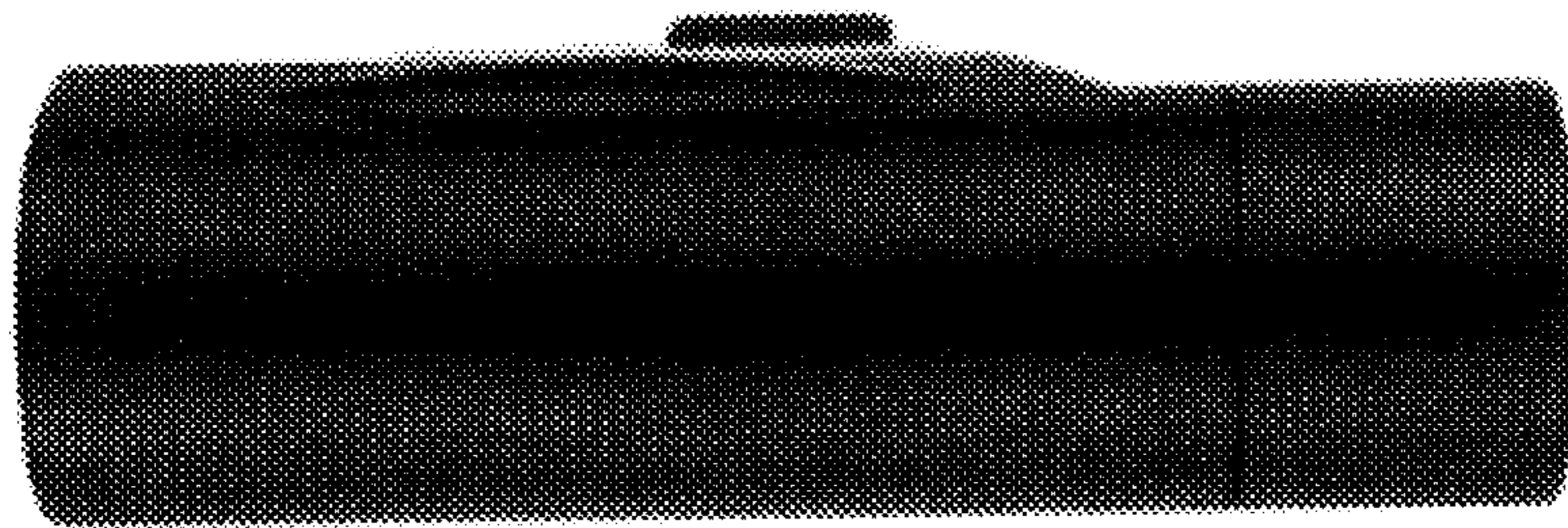

FIG. 7

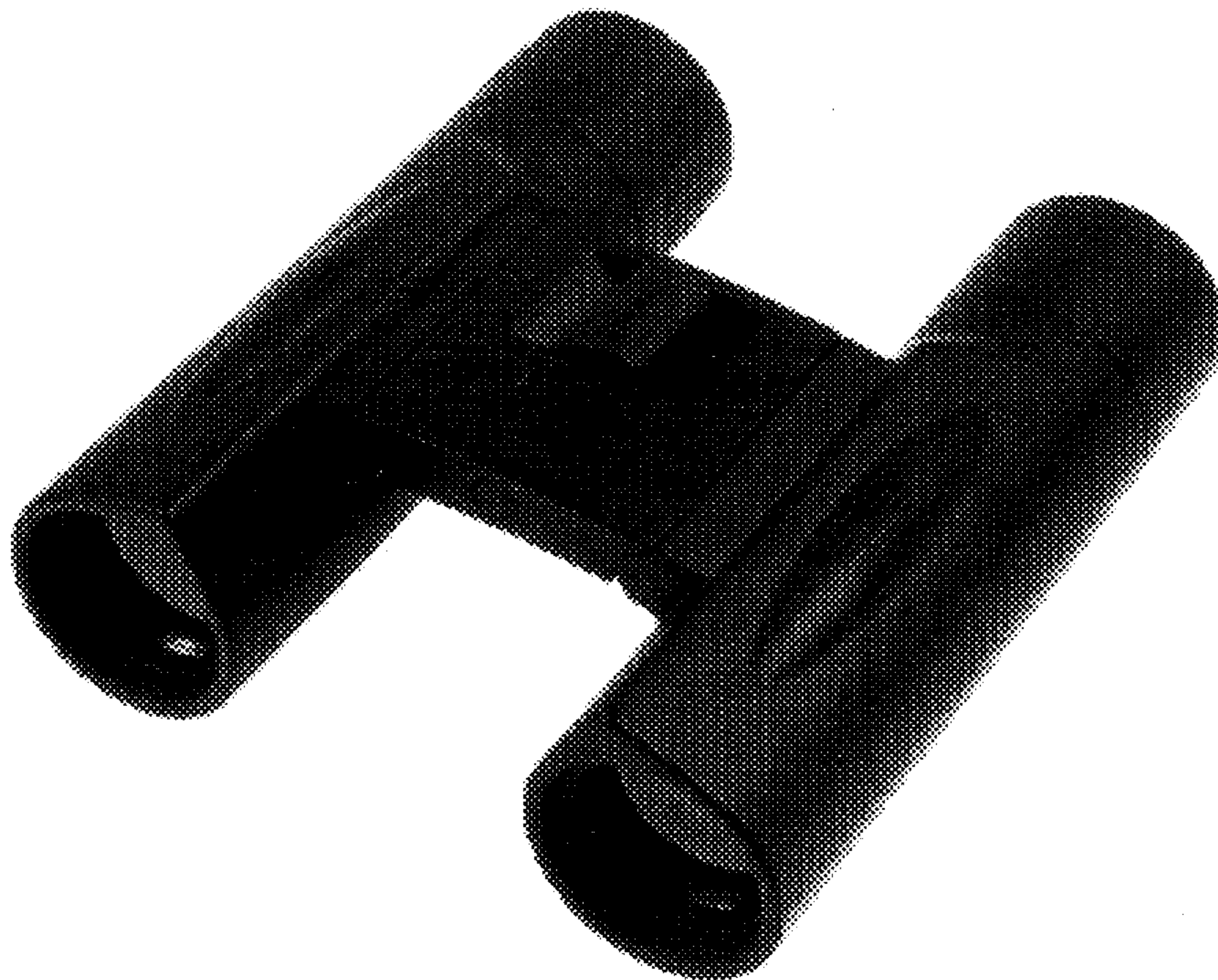

FIG. 8



UNITED STATES PATENT AND TRADEMARK OFFICE
CERTIFICATE OF CORRECTION

PATENT NO. : Des. 392,986
DATED : March 31, 1998
INVENTOR(S) : Takaharu KATO

It is certified that error appears in the above-identified patent and that said Letters Patent is hereby corrected as shown below:

Title page, in items [19] and [75], change "Katou" to --Kato--.

Signed and Sealed this
Twenty-third Day of June, 1998



Attest:

BRUCE LEHMAN

Attesting Officer

Commissioner of Patents and Trademarks