

US00D392971S

United States Patent [19]

Pisutha-Arnond et al.

[11] Patent Number: **Des. 392,971**

[45] Date of Patent: ****Mar. 31, 1998**

[54] **PORTABLE COMMUNICATION DEVICE**

[75] Inventors: **Num Pisutha-Arnond**, Wheeling, Ill.;
Richard M. Huber, Boca Raton;
Donald L. Branner, Coral Springs,
both of Fla.

[73] Assignee: **Motorola, Inc.**, Schaumburg, Ill.

[**] Term: **14 Years**

[21] Appl. No.: **60,733**

[22] Filed: **Oct. 4, 1996**

[51] LOC (6) Cl. **14-03**

[52] U.S. Cl. **D14/191**

[58] Field of Search D14/124, 188,
D14/191-192, 299; 340/311.1; 455/38.1-38.4,
90, 92, 100, 128, 344

[56] **References Cited**

U.S. PATENT DOCUMENTS

D. 278,905 5/1985 Scheid et al. D14/191

D. 321,877 11/1991 Scheid et al. D14/191
D. 327,269 6/1992 Totsuka et al. D14/197
D. 369,168 4/1996 Yano D14/191

Primary Examiner—Sandra L. Morris
Assistant Examiner—Nanda Bondade

[57] **CLAIM**

The ornamental design for a portable communication device, as shown and described.

DESCRIPTION

FIG. 1 is a front view of a preferred embodiment of a portable communication device in accordance with our new design;

FIG. 2 is a top view of the preferred embodiment;

FIG. 3 is a bottom view of the preferred embodiment;

FIG. 4 is a rear side view of the preferred embodiment;

FIG. 5 is a right side view of the preferred embodiment;

FIG. 6 is a left side view of the preferred embodiment; and,

FIG. 7 is a perspective view of the preferred embodiment.

1 Claim, 3 Drawing Sheets

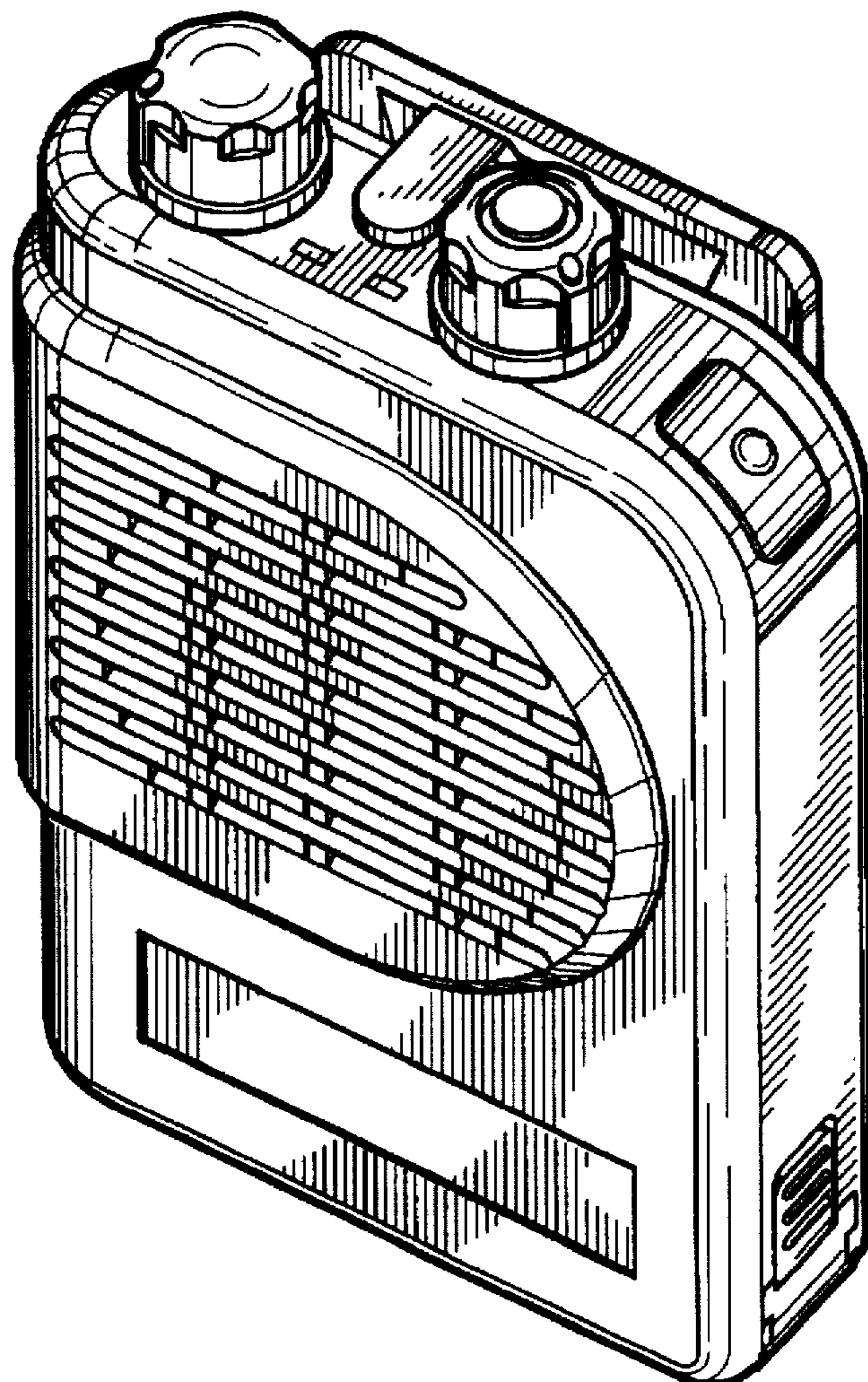

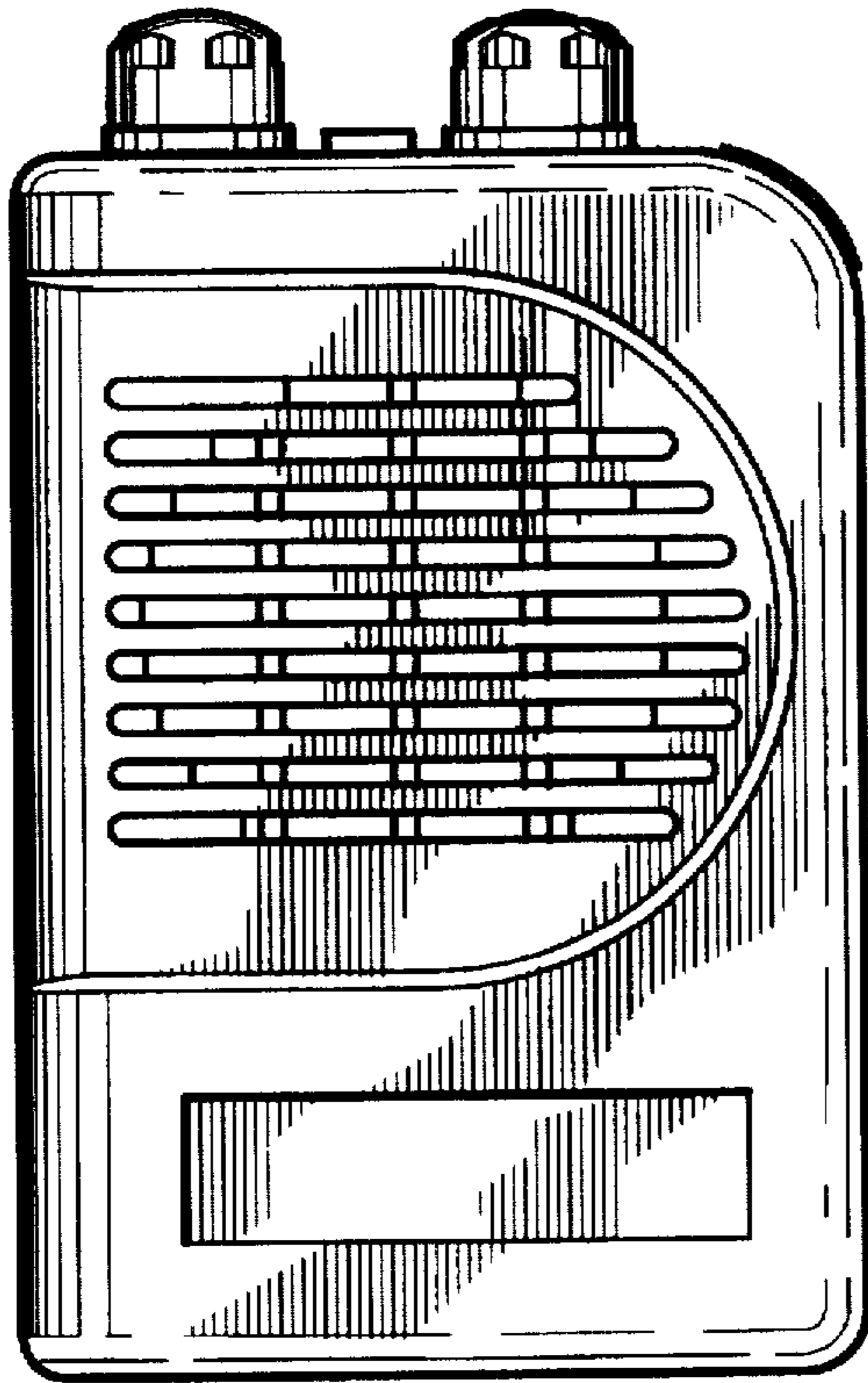

FIG. 1

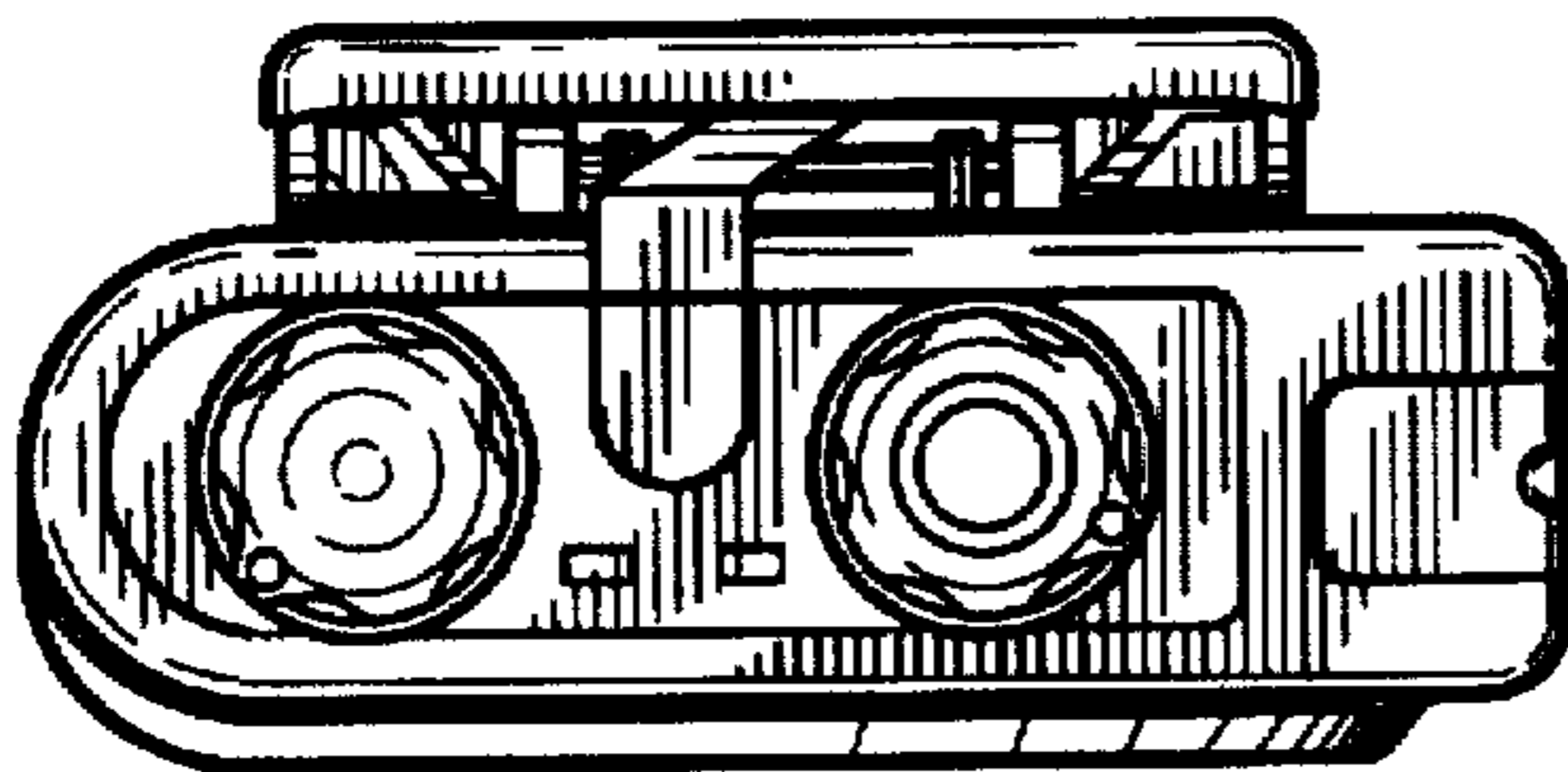

FIG. 2

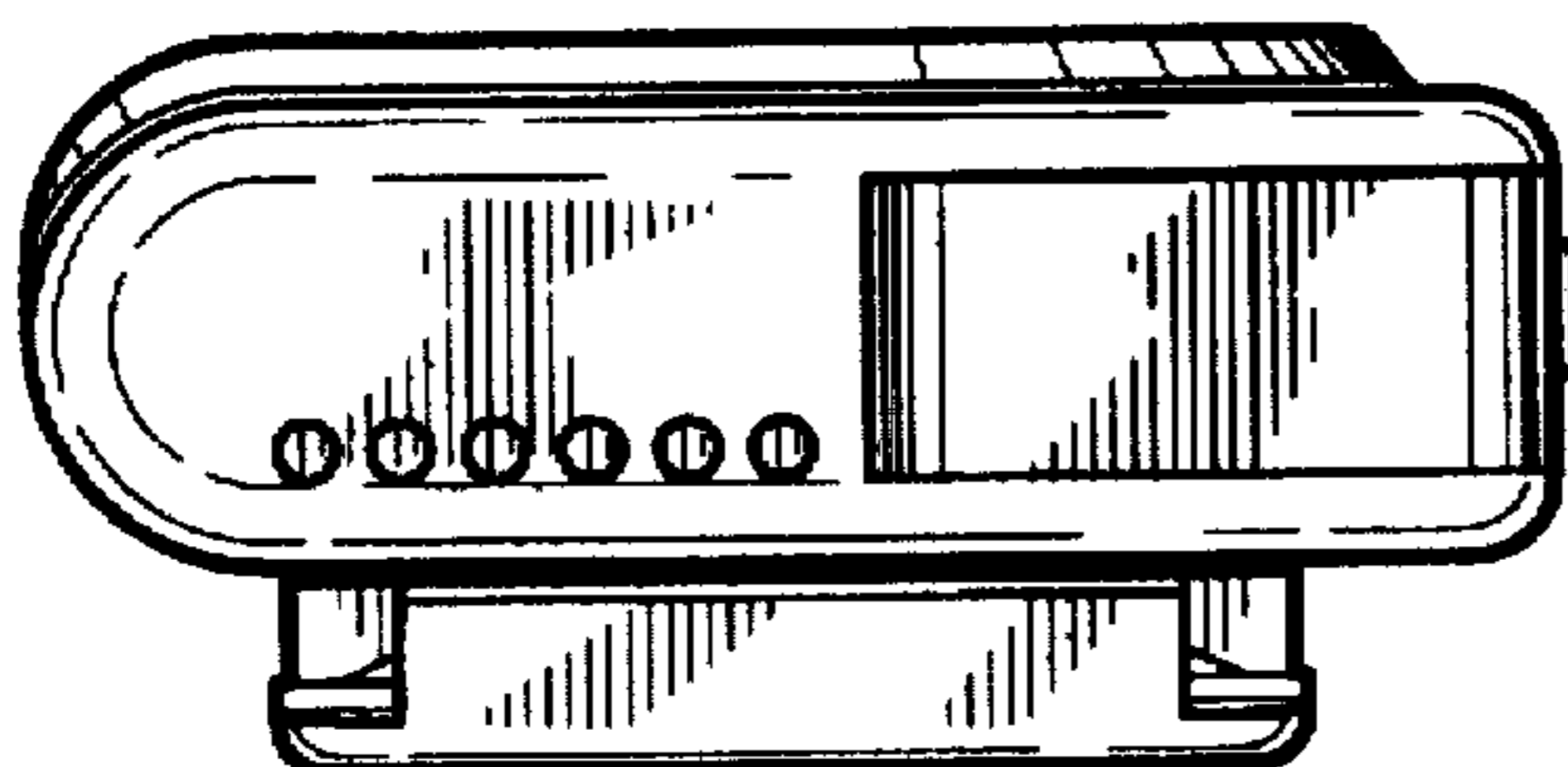

FIG. 3

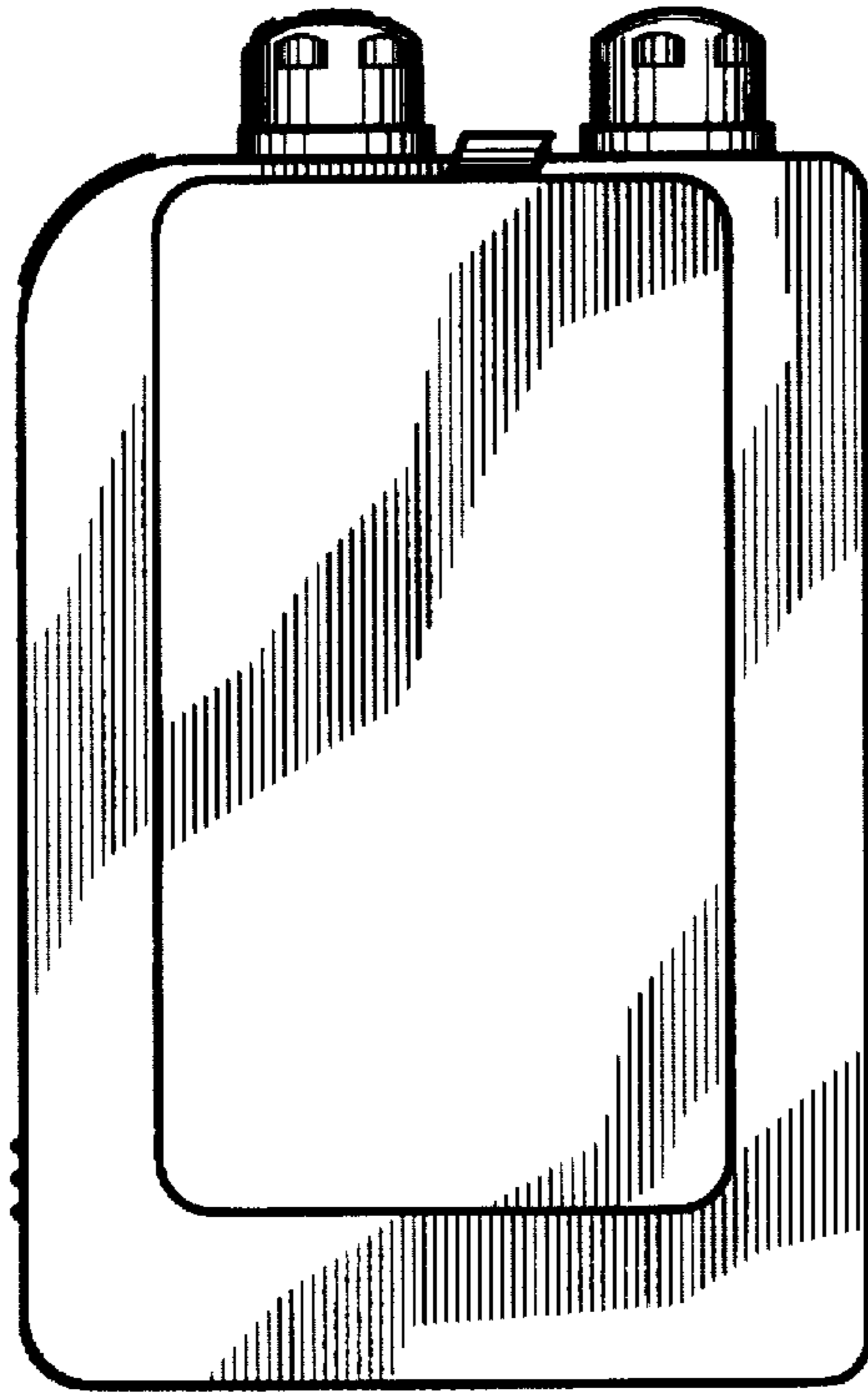

FIG. 4

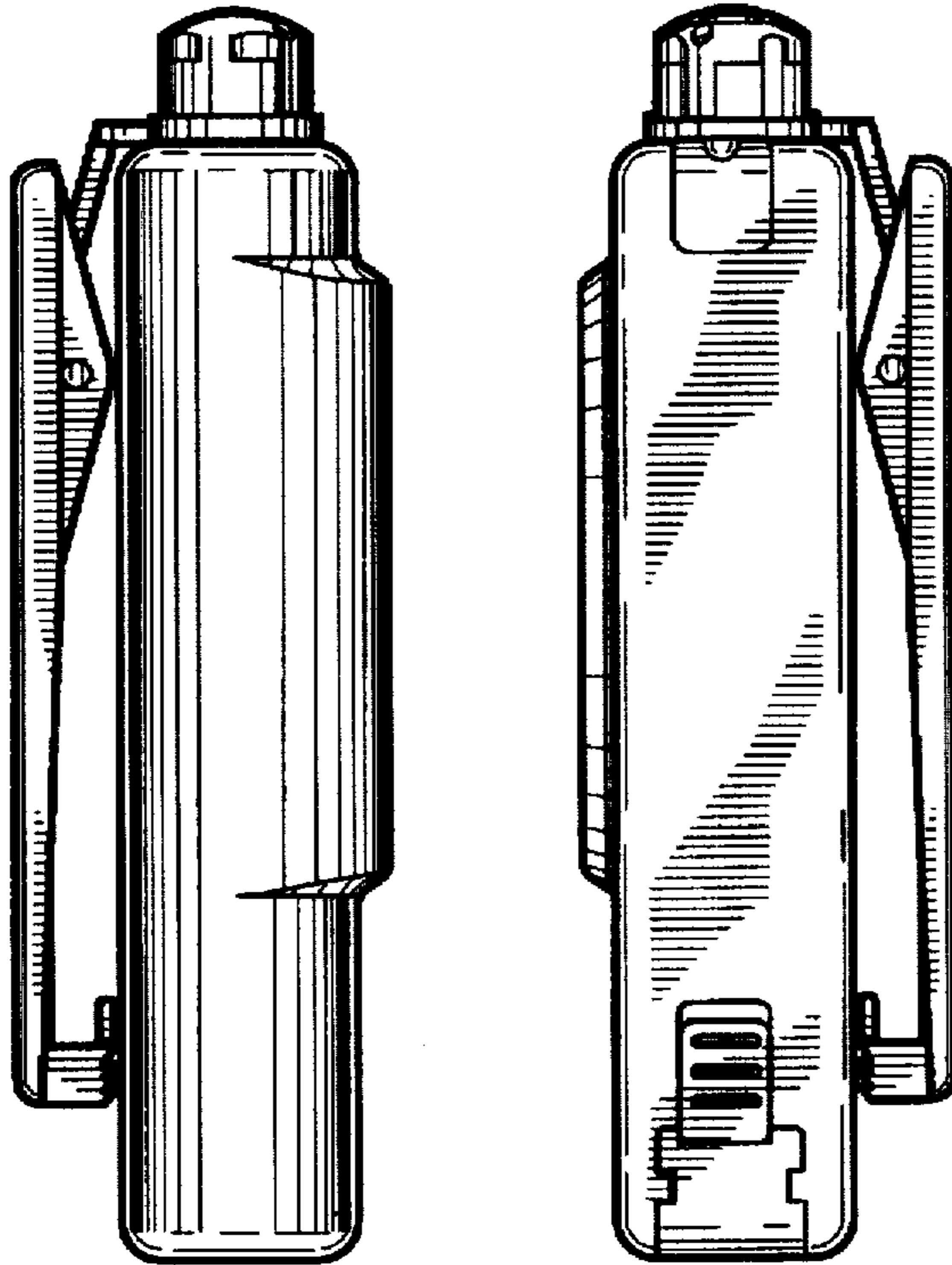

FIG. 5 *FIG. 6*

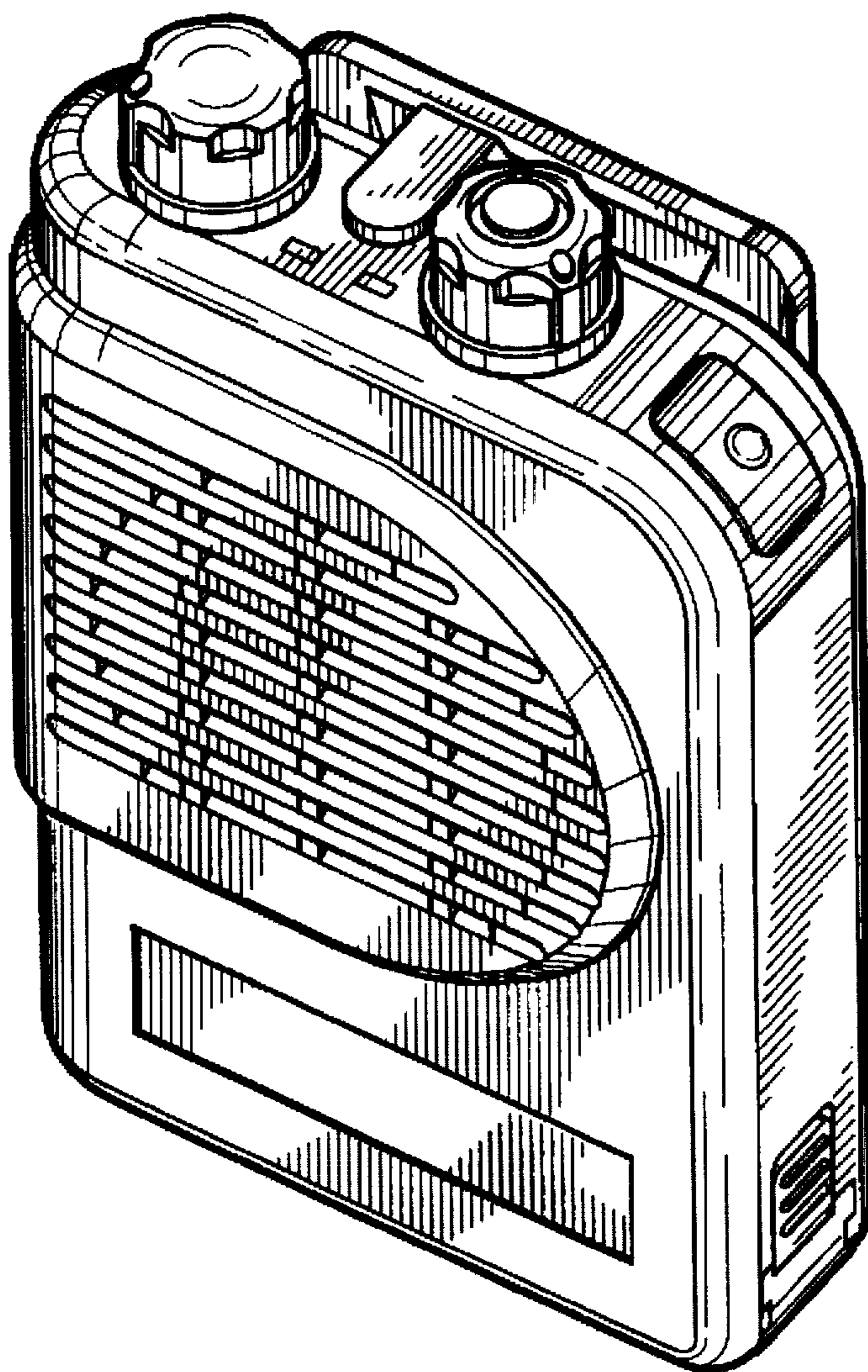

FIG. 7