



US00D392929S

**United States Patent** [19]  
**Lombard**

[11] **Patent Number: Des. 392,929**  
[45] **Date of Patent: \*\*Mar. 31, 1998**

[54] **VEHICLE HUB CAP**

[76] **Inventor: Charles Lombard, S. 515 Farr Rd.,  
Spokane, Wash. 99206-3561**

[\*\*] **Term: 14 Years**

[21] **Appl. No.: 68,711**

[22] **Filed: Mar. 20, 1997**

[51] **LOC (6) CL. .... 12-16**

[52] **U.S. Cl. .... D12/204**

[58] **Field of Search .... D12/204-213,  
D12/197-201; 301/64.1, 65, 37.1**

D. 193,295	7/1962	Carlson	.....	D12/204
D. 196,718	10/1963	Holls	.....	D12/207
D. 202,774	11/1965	Nash	.....	D12/204
D. 271,293	11/1983	Polka	.....	D12/204
D. 303,103	8/1989	Brouch et al.	.....	D12/207
3,005,906	10/1961	Butler, Jr.	.....	301/65 X
3,015,295	1/1962	Lyon	.....	301/65 X

*Primary Examiner*—James Gandy  
*Assistant Examiner*—Stacia Sinuik  
*Attorney, Agent, or Firm*—Mallinckrodt & Mallinckrodt

[57] **CLAIM**

The ornamental design for a vehicle hub cap, as shown and described.

**DESCRIPTION**

FIG. 1 is a front elevational view of a vehicle hub cap showing my new design;  
FIG. 2 is a bottom plan view thereof;  
FIG. 3 is a rear elevational view thereof;  
FIG. 4 is a right side elevational view thereof;  
FIG. 5 is a bottom front pictorial view thereof; and,  
FIG. 6 is a bottom rear pictorial view thereof with the hub cap rotated about forty-five degrees.

**1 Claim, 1 Drawing Sheet**

[56] **References Cited**

**U.S. PATENT DOCUMENTS**

D. 39,272	4/1908	Waldon	.....	D12/197
D. 76,242	9/1928	Hughes et al.	.....	D12/197
D. 80,711	3/1930	Toncray	.....	D12/204
D. 130,779	12/1941	Plotkin	.....	D12/204
D. 170,233	8/1953	Plotkin	.....	D12/204
D. 170,972	12/1953	Gaylord	.....	D12/204
D. 182,932	5/1958	Smith	.....	D12/204
D. 185,848	8/1959	Plotkin	.....	D12/204
D. 188,536	8/1960	Nixon	.....	D12/204
D. 191,420	9/1961	Shaar	.....	D12/197 X

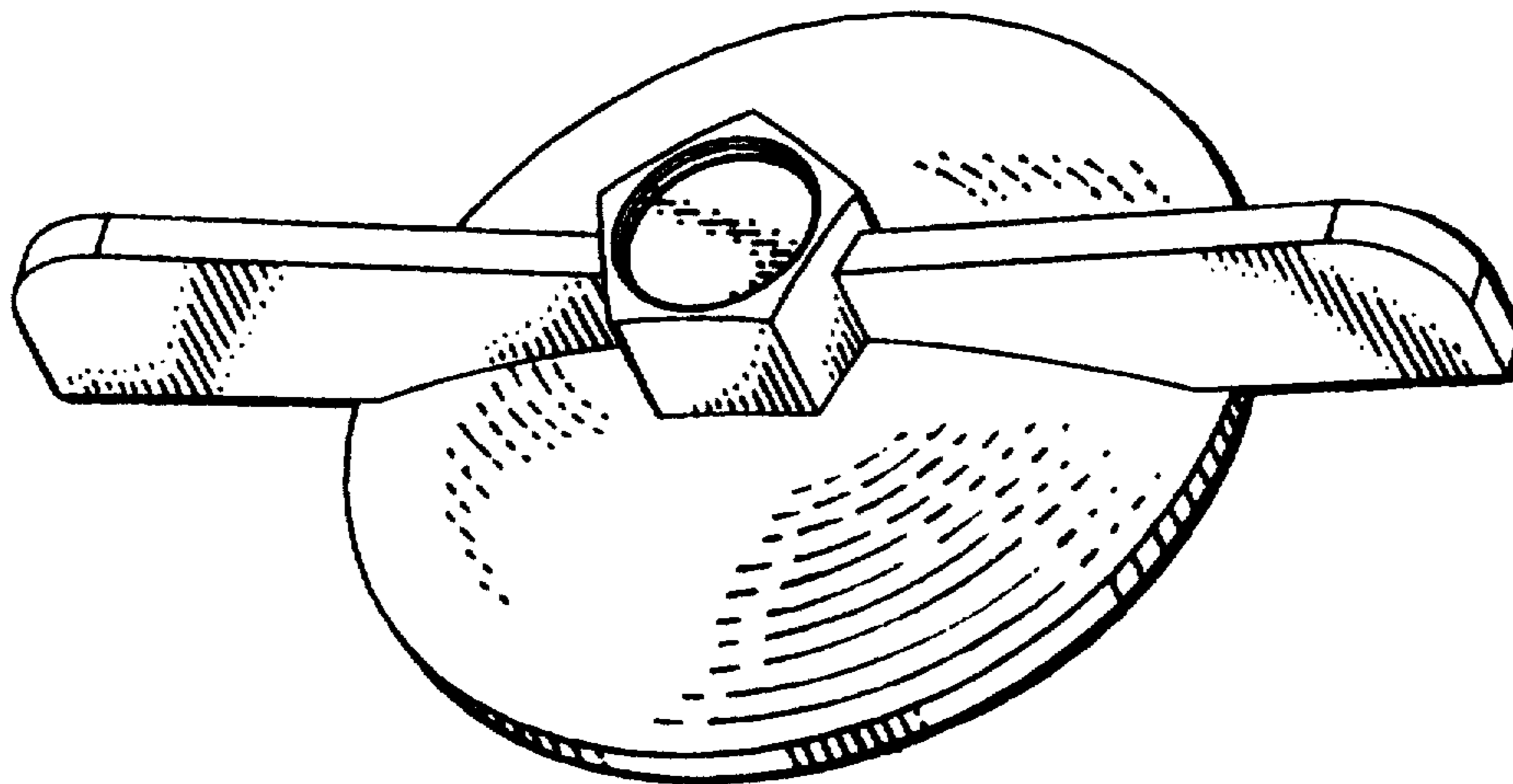

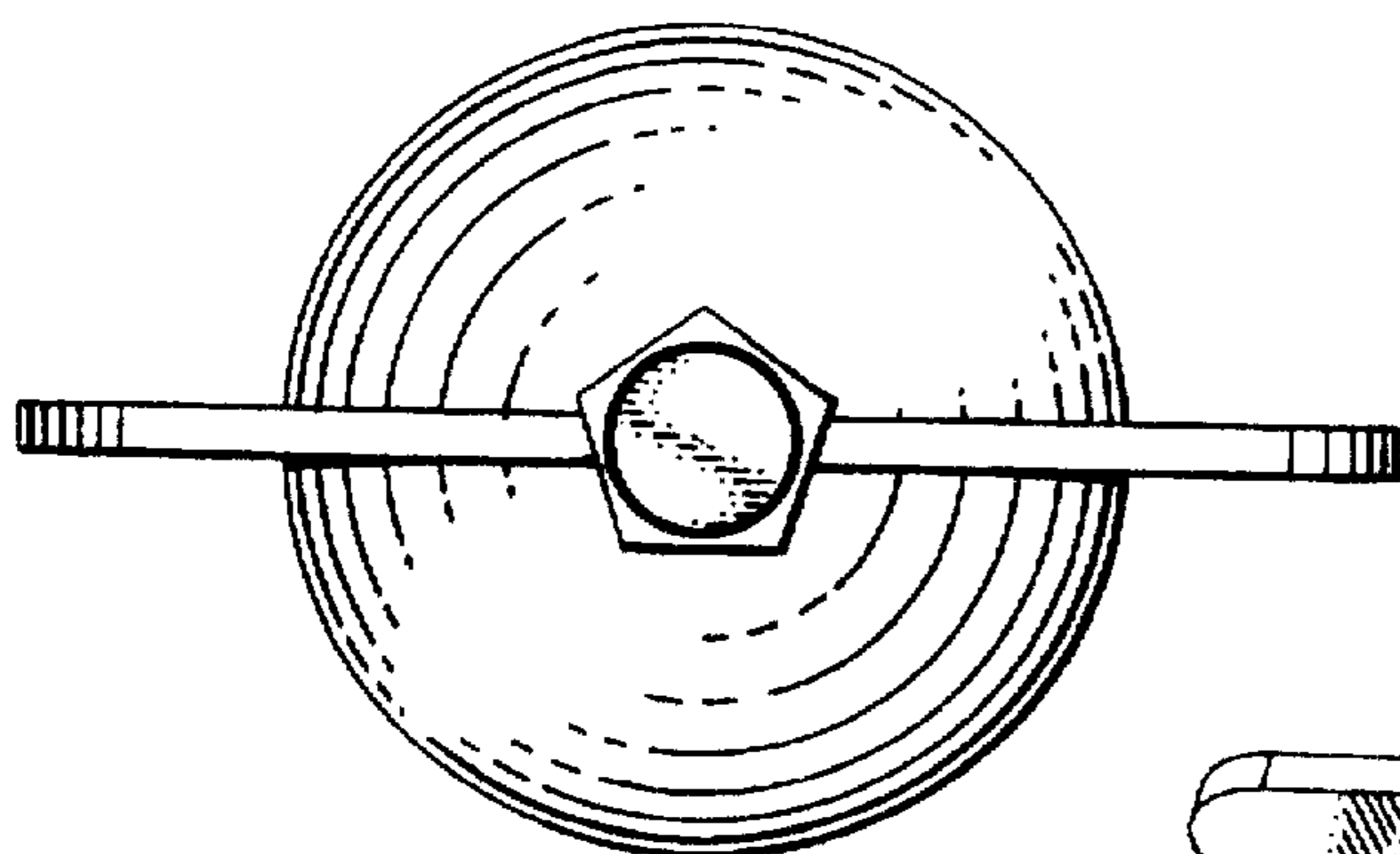

FIGURE 1

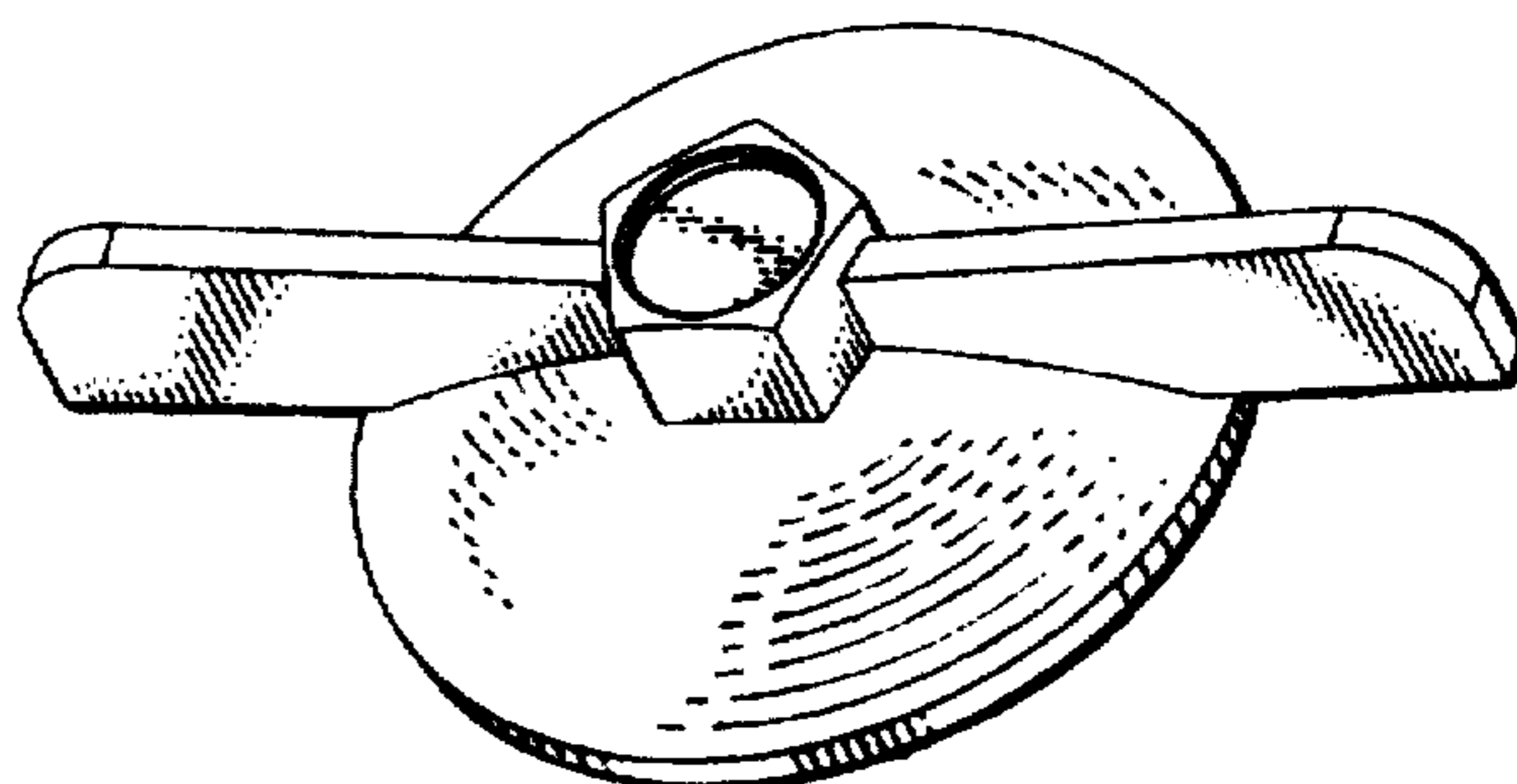

FIGURE 5

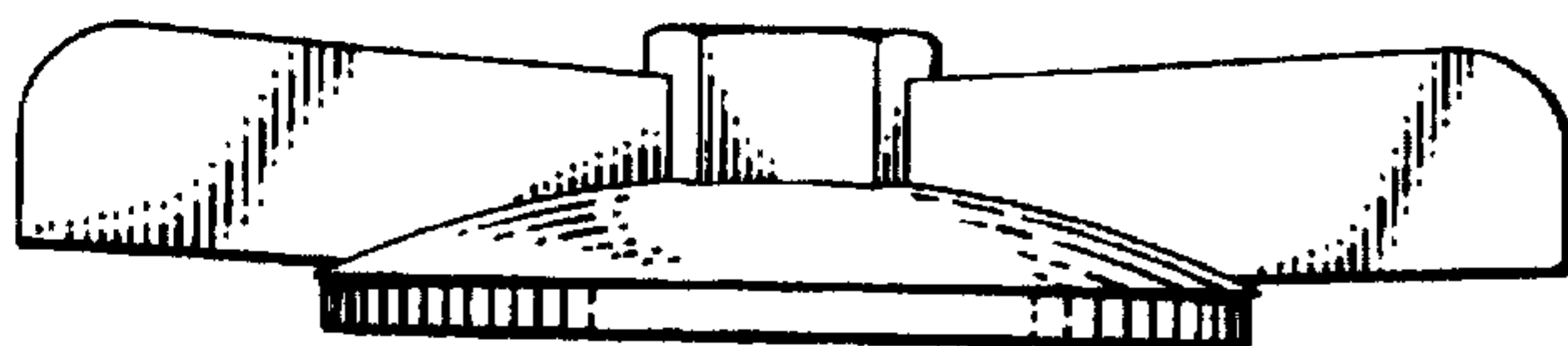

FIGURE 2

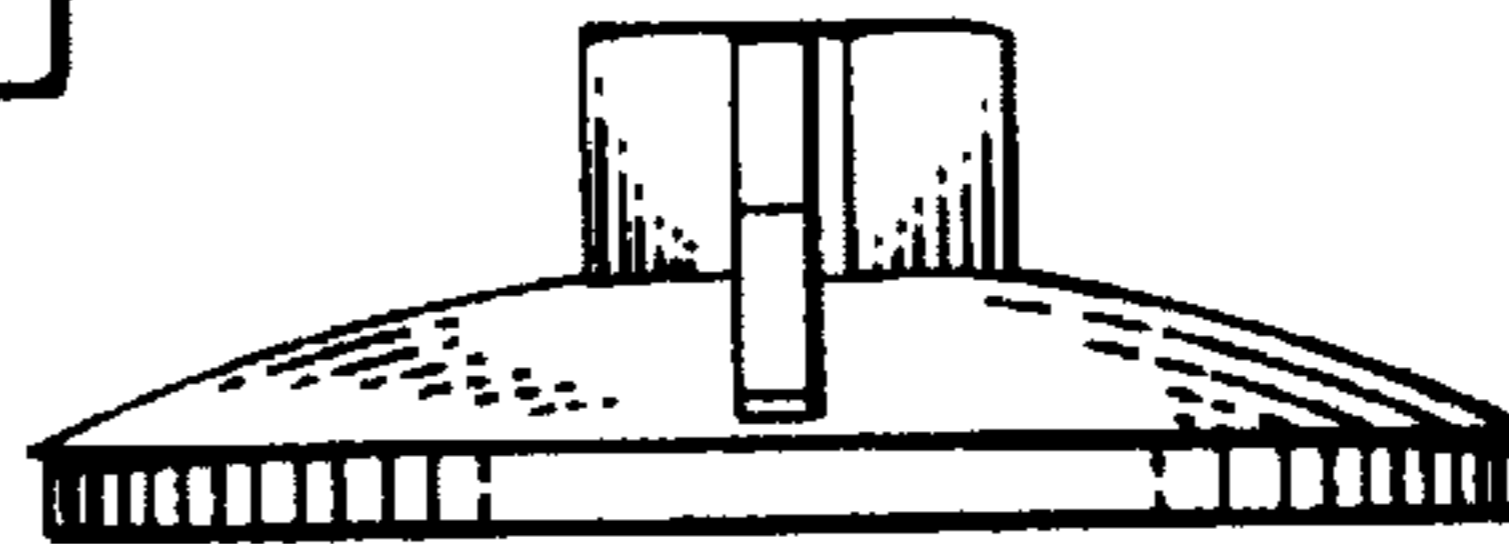

FIGURE 4

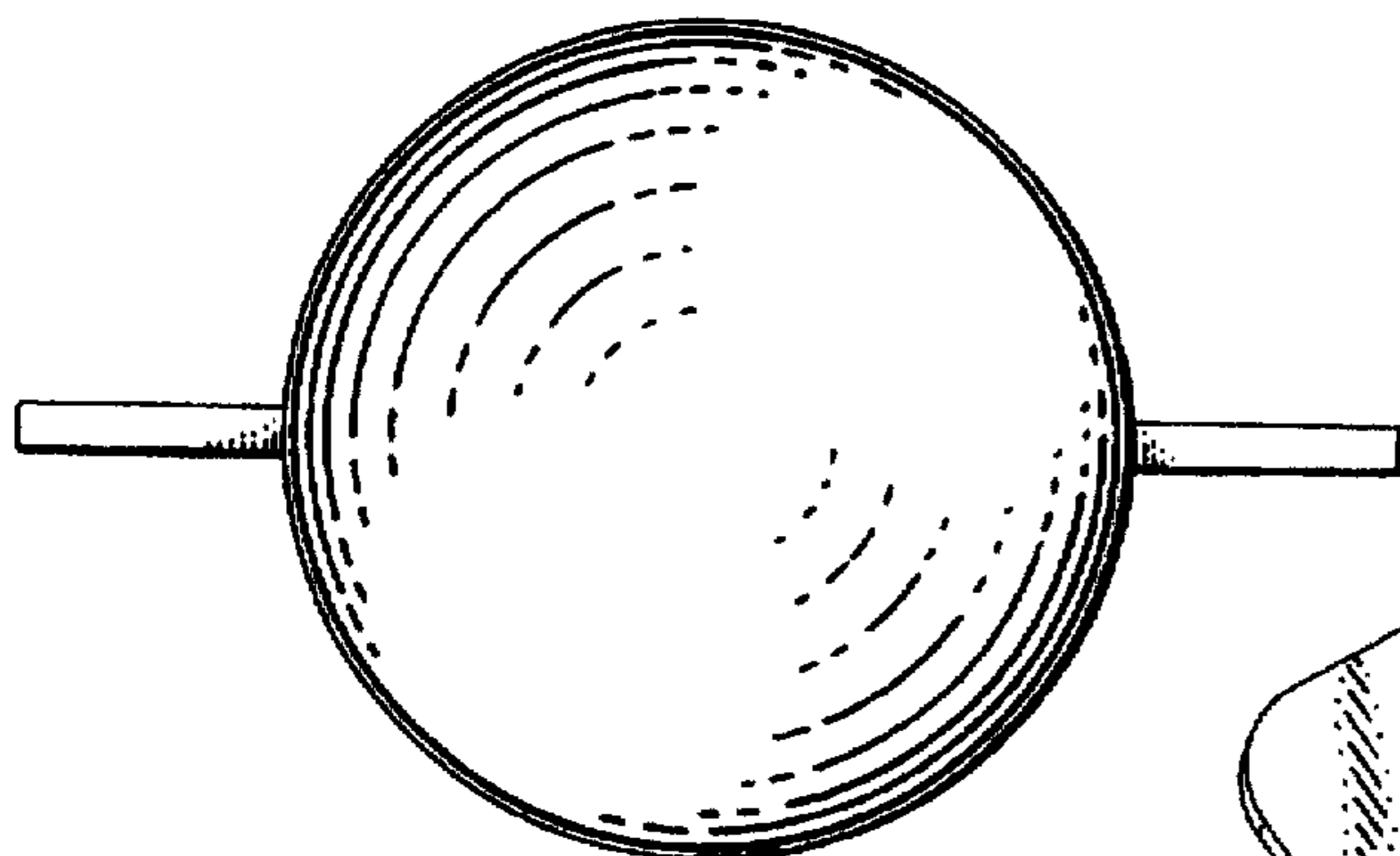

FIGURE 3

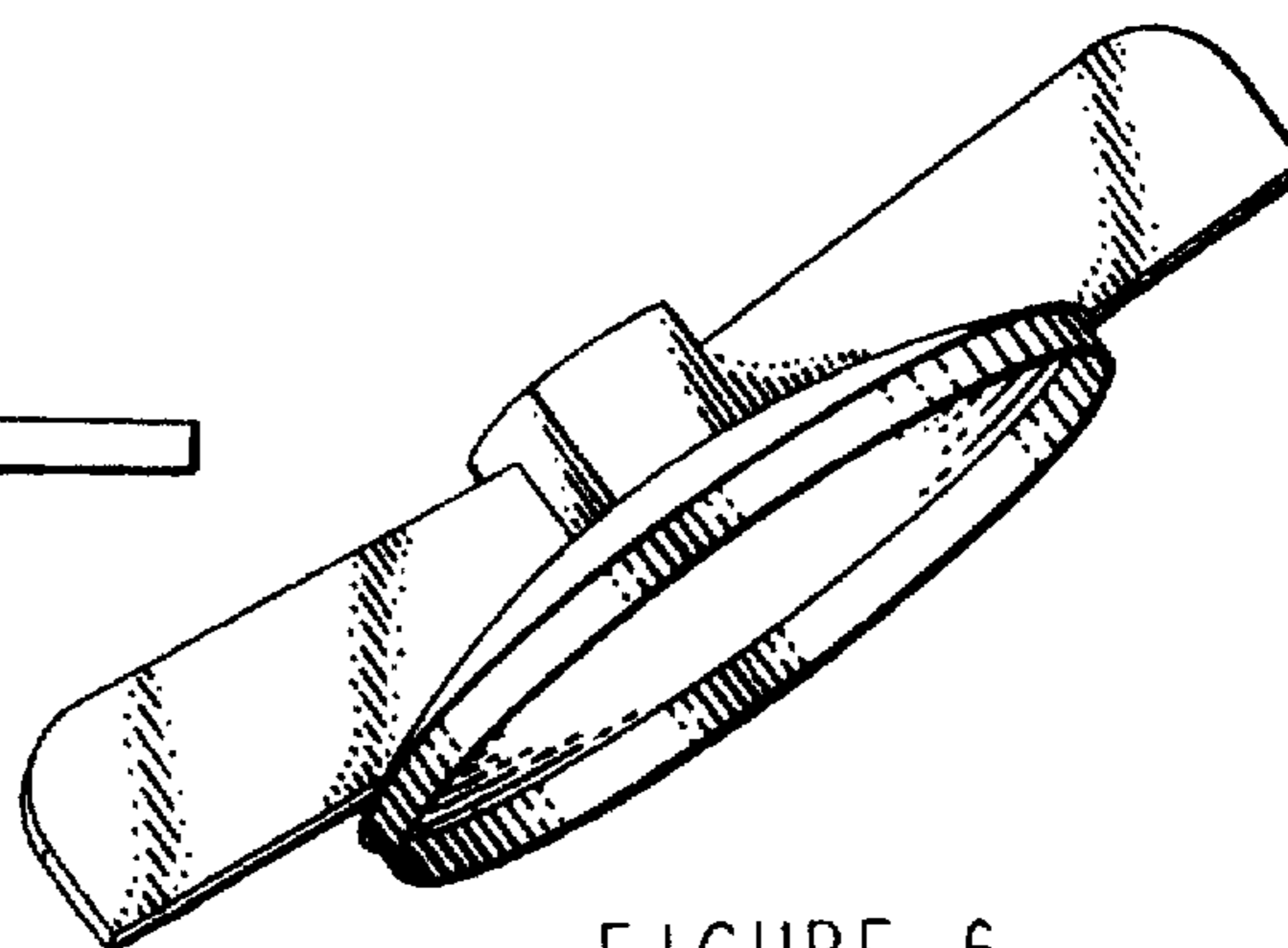

FIGURE 6