

US00D392846S

# United States Patent [19]

[11] Patent Number: Des. 392,846

Zeller

[45] Date of Patent: \*\*Mar. 31, 1998

[54] **BARBECUE SET**

[75] Inventor: Nicole A. Zeller, Harrison, N.Y.

[73] Assignee: Zelco Industries, Inc., Mount Vernon, N.Y.

[\*\*] Term: 14 Years

[21] Appl. No.: 67,151

[22] Filed: Mar. 5, 1997

[51] LOC (6) Cl. .... 07-07

[52] U.S. Cl. .... D7/638

[58] Field of Search ..... D3/200, 201, 273, D3/274, 276, 281, 283, 284, 294; D7/637-641, 683, 688-692; 30/322, 323, 142, 147-8, 150; 190/16, 100, 109, 115, 117, 900; 206/349, 553, 372, 557, 562-3; 294/7, 8, 3, 8.5, 11, 16, 99.1, 99.2, 118, 119, 61, 55.5

[56] **References Cited**

**U.S. PATENT DOCUMENTS**

D. 175,304	8/1955	Gorin	.....	D7/692
D. 254,767	4/1980	Christen, Jr.	.....	D7/686
D. 302,776	8/1989	Hiscott et al.	.....	D7/692
D. 351,092	10/1994	Weber	.....	D7/683
D. 351,504	10/1994	Tarozzi	.....	D3/273 X
D. 357,117	4/1995	Huang	.....	D3/276
2,747,911	5/1956	Kuever	.....	294/7 X
3,906,632	9/1975	Oppenheimer	.....	30/322
5,206,998	5/1993	Oriente et al.	.....	30/322 X

Primary Examiner—Terry A. Wallace

Attorney, Agent, or Firm—Donald S. Dowden

[57] **CLAIM**

The ornamental design for a barbecue set, as shown and described.

**DESCRIPTION**

FIG. 1 is a top view showing a first part of my new design in an extended state;

FIG. 2 is a right side view thereof;

FIG. 3 is a left side view thereof;

FIG. 4 is a front view thereof, the rear view thereof being identical thereto;

FIG. 5 is a bottom view thereof;

FIG. 6 is a top view showing a second part of my new design in an extended state;

FIG. 7 is a bottom view thereof;

FIG. 8 is a front view thereof, the rear view thereof being identical thereto;

FIG. 9 is a left side view thereof;

FIG. 10 is a right side view thereof;

FIG. 11 is a top view showing a third part of my new design in an extended state;

FIG. 12 is a bottom view thereof;

FIG. 13 is a front view thereof, the rear view thereof being identical thereto;

FIG. 14 is a left view thereof;

FIG. 15 is a right view thereof;

FIG. 16 is a top view showing a fourth part of my new design in an extended state, the bottom view thereof being identical thereto;

FIG. 17 is a front view thereof, the rear view thereof being identical thereto;

FIG. 18 is a right side view thereof;

FIG. 19 is a left side view thereof;

FIG. 20 is a bottom view of the top half thereof, the top view of the bottom half thereof being identical thereto;

FIG. 21 is a view corresponding to FIG. 4 but showing a retracted state;

FIG. 22 is a view corresponding to FIG. 8 but showing a retracted state;

FIG. 23 is a view corresponding to FIG. 13 but showing a retracted state;

FIG. 24 is a view corresponding to FIG. 17 but showing a retracted state;

FIG. 25 is a front view showing a fifth part of my new design in a closed state;

FIG. 26 is a top view thereof;

FIG. 27 is a bottom view thereof;

FIG. 28 is a rear view thereof;

FIG. 29 is a right side view thereof, the left side being a mirror image thereof;

FIG. 30 is a perspective view thereof in an open state with the first through fourth parts removed; and,

FIG. 31 is a top view of a lower portion thereof with the first through fourth parts stored therein.

**1 Claim, 12 Drawing Sheets**

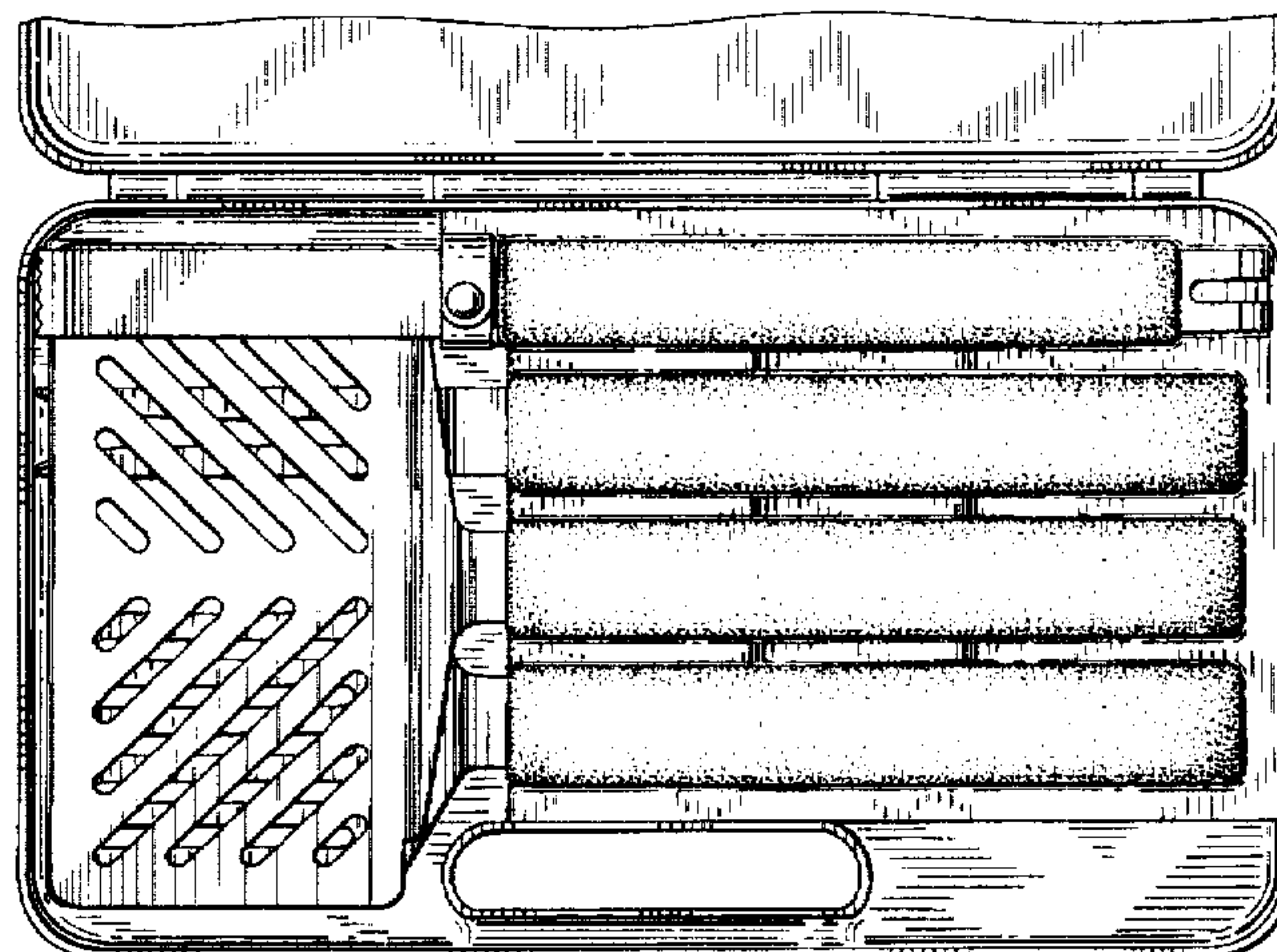

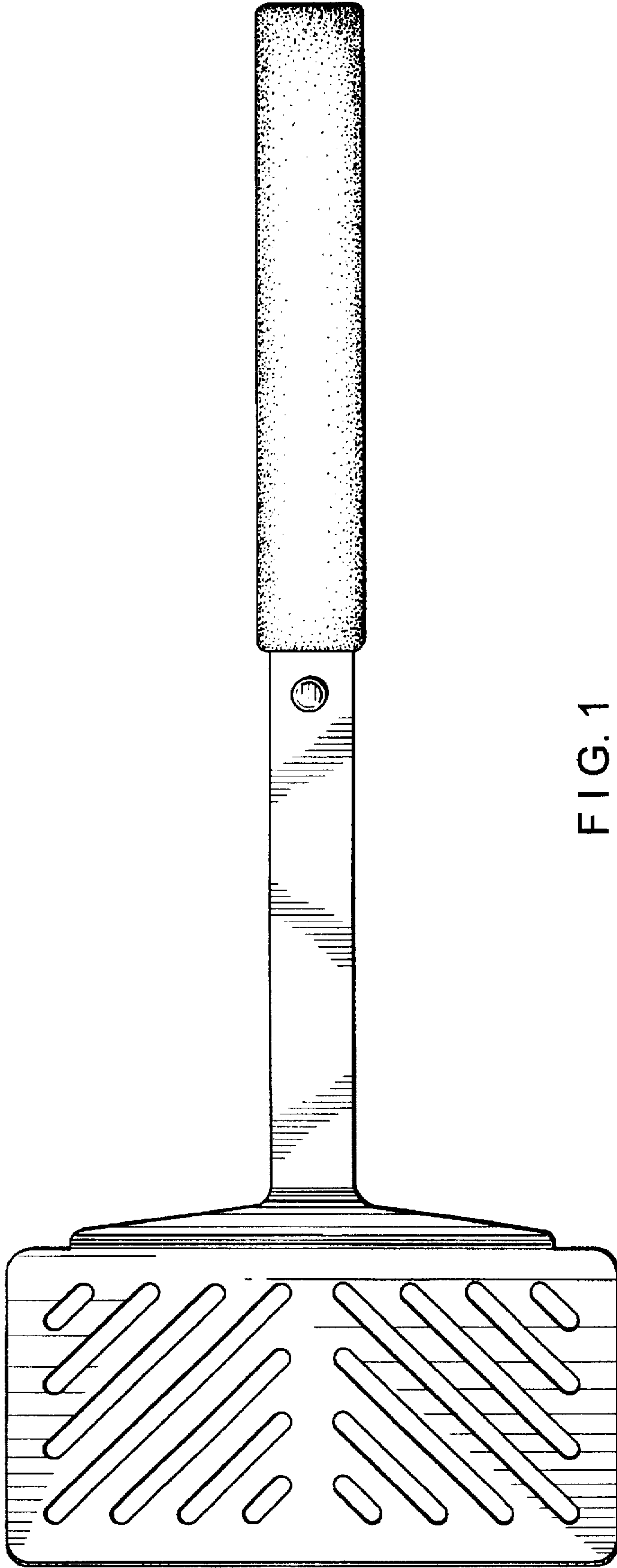

FIG. 1

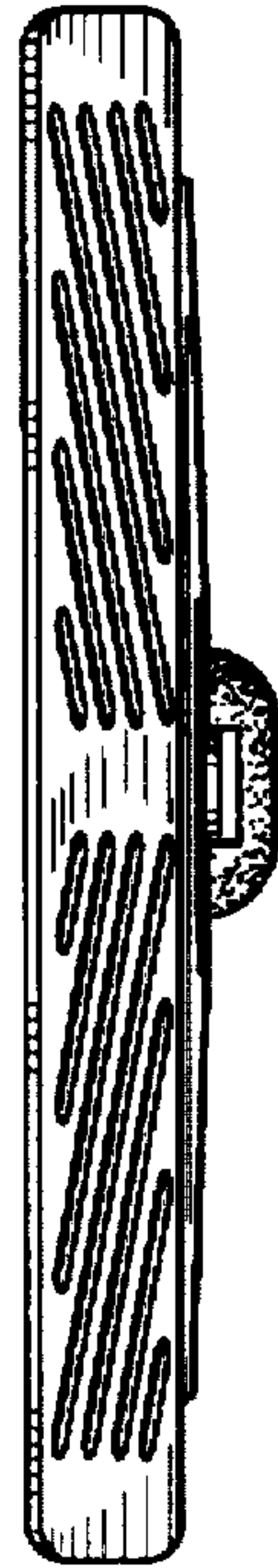

FIG. 3

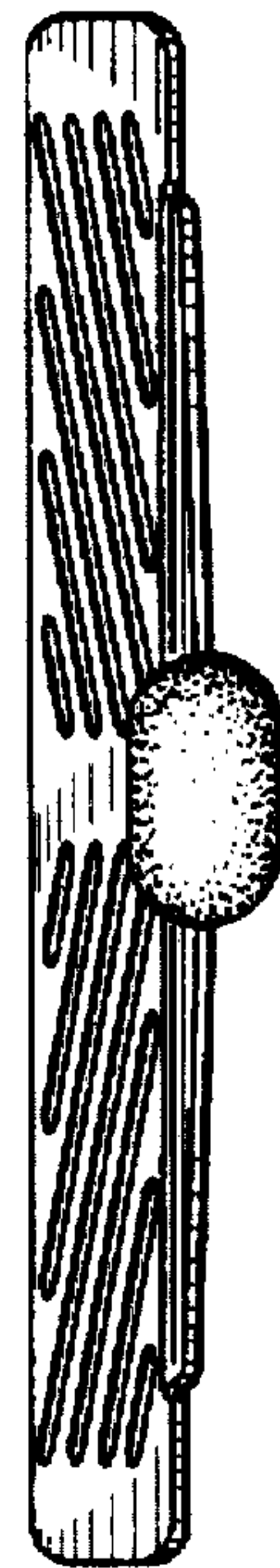

FIG. 2

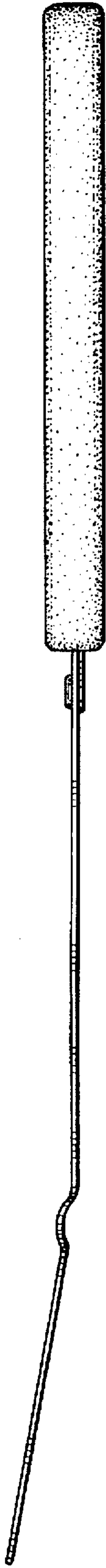

FIG. 4

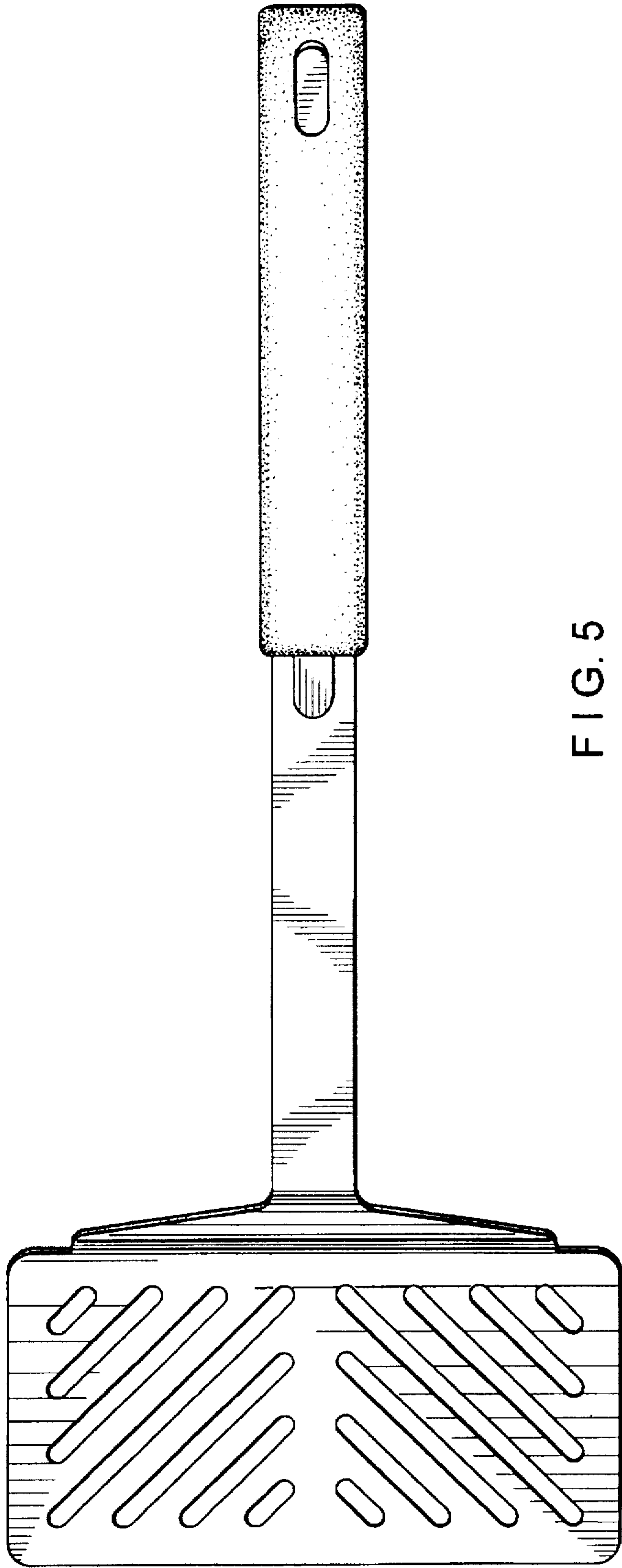

FIG. 5



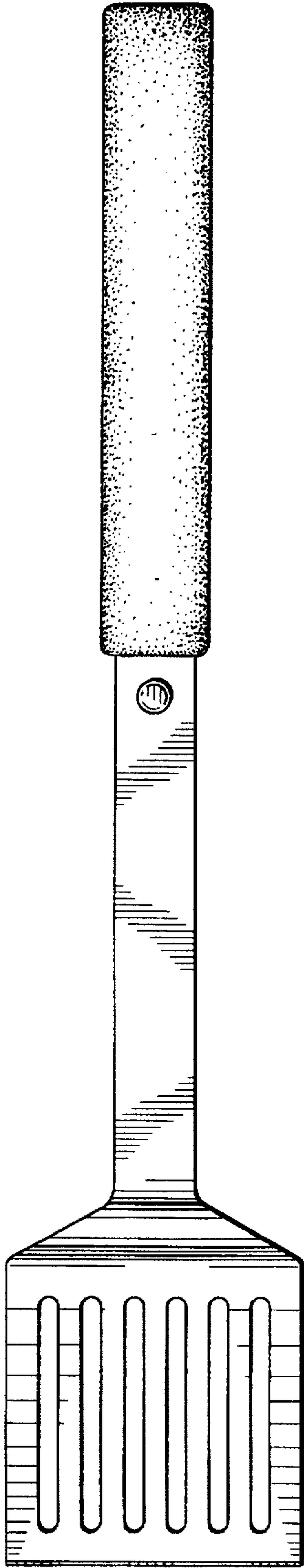

FIG. 6

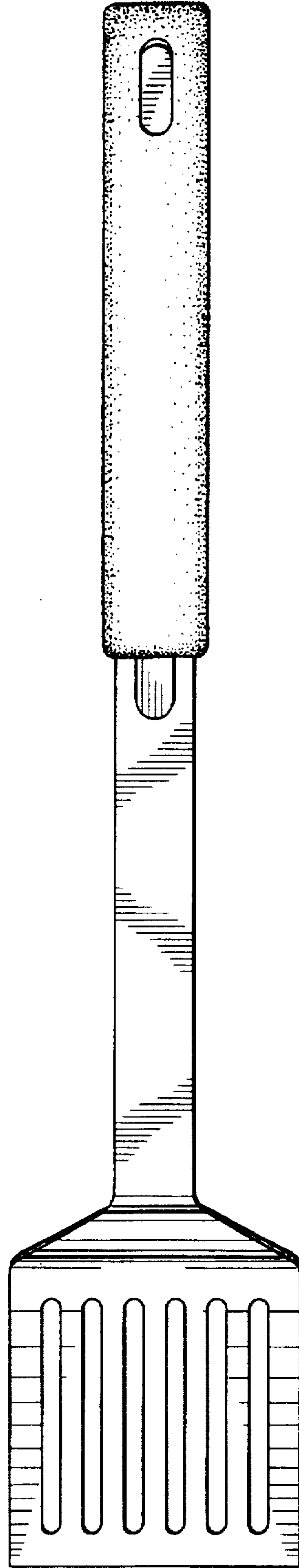

FIG. 7

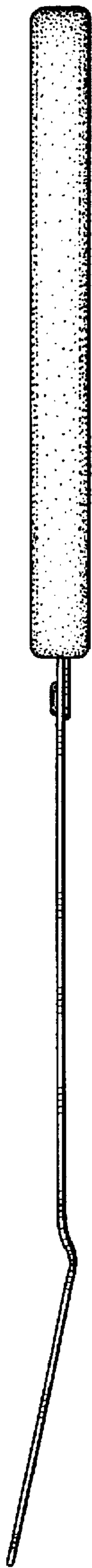

FIG. 8

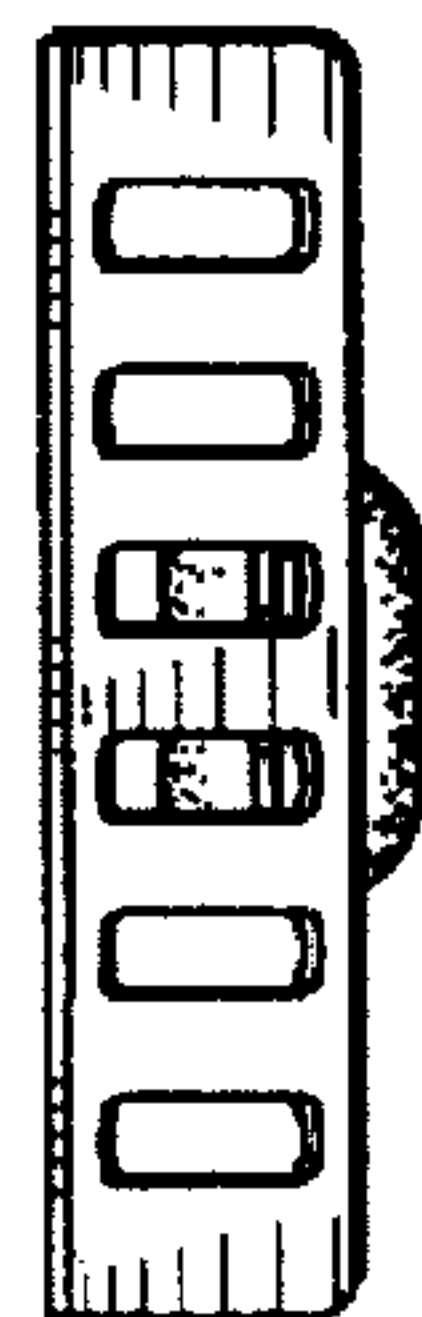

FIG. 9

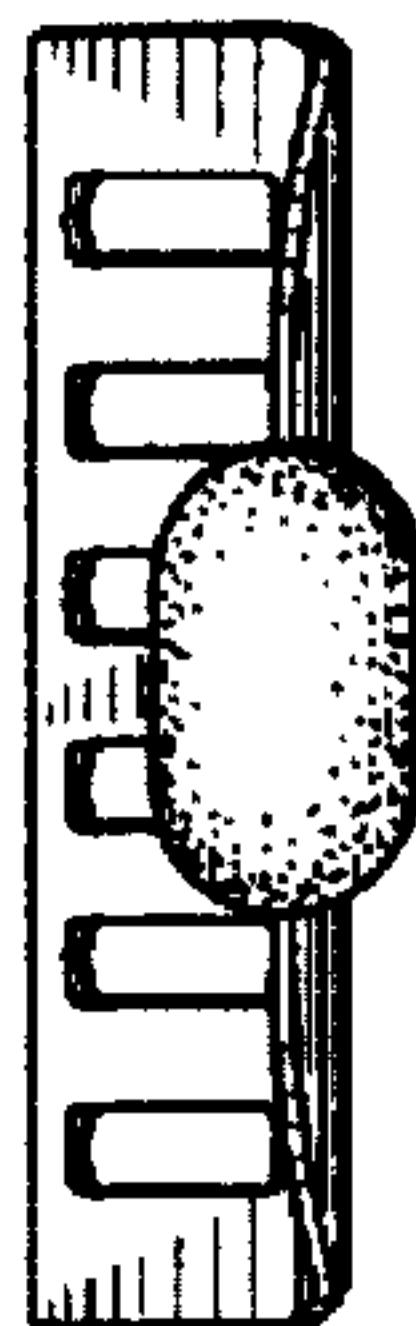

FIG. 10

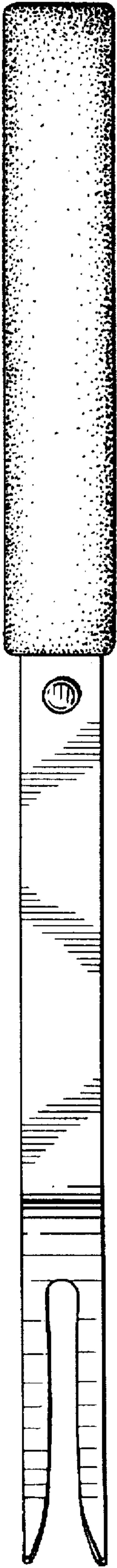

FIG. 11

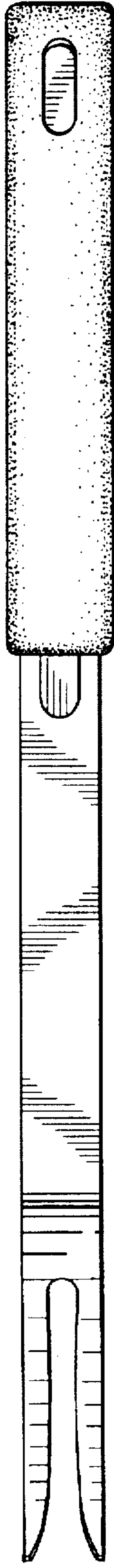

FIG. 12

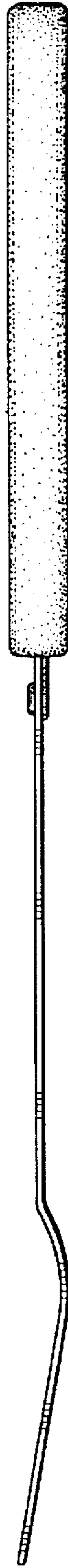

FIG. 13



FIG. 14

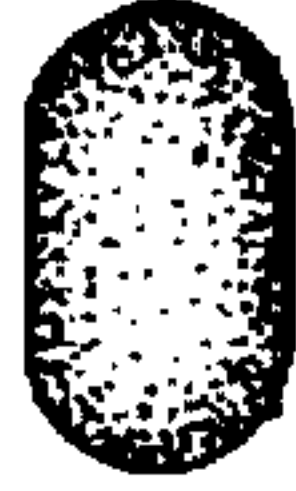

FIG. 15

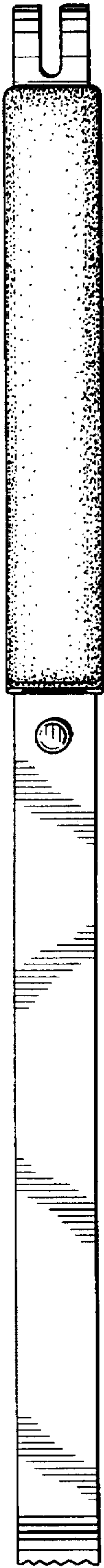

FIG. 16

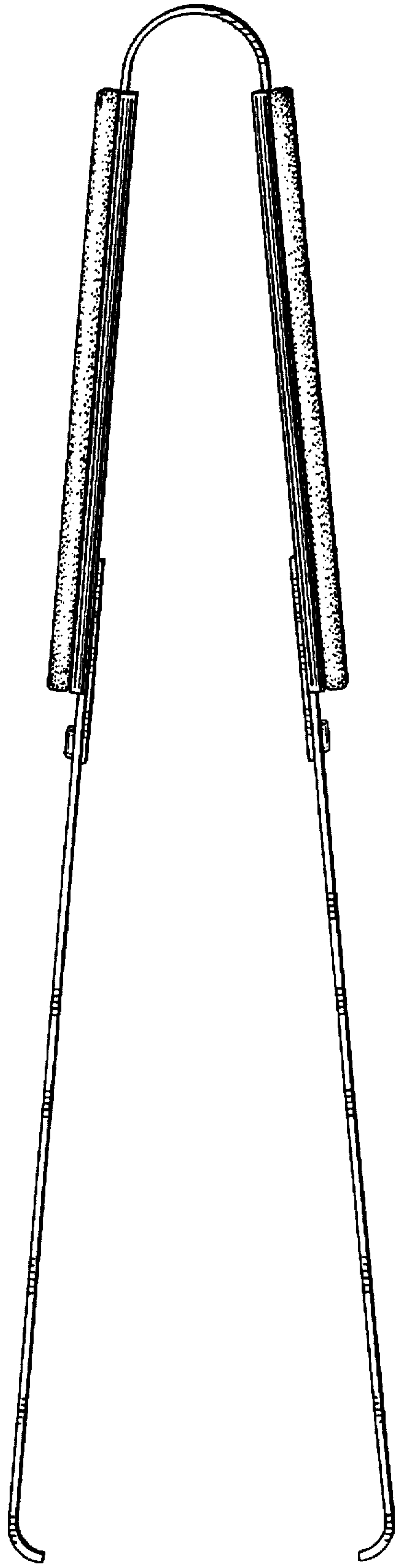

FIG. 17

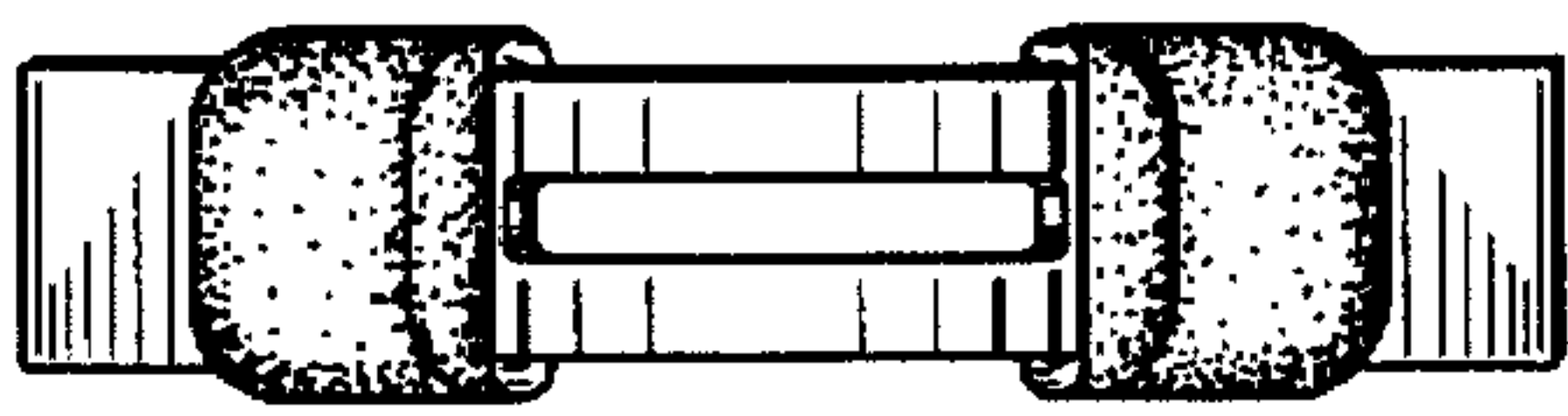

FIG. 18

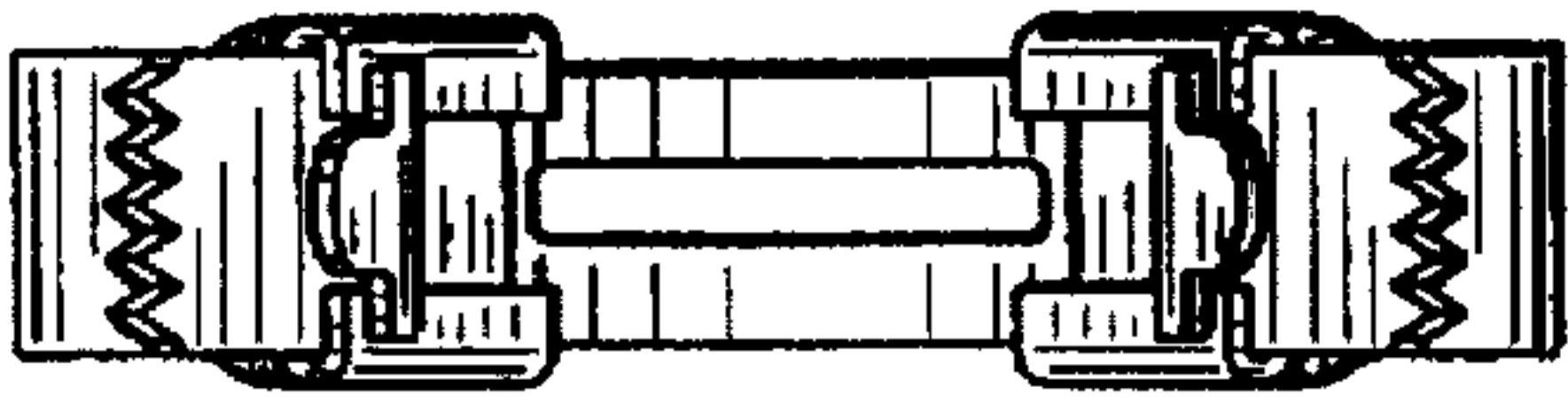

FIG. 19

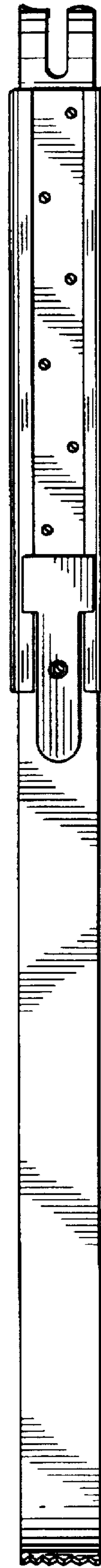

FIG. 20



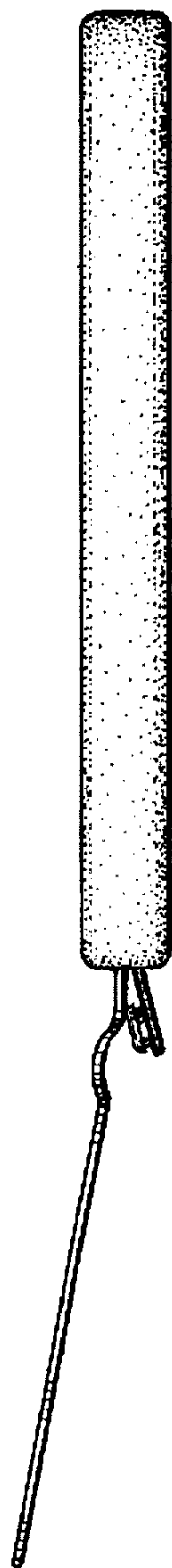

FIG. 21



FIG. 22



FIG. 23

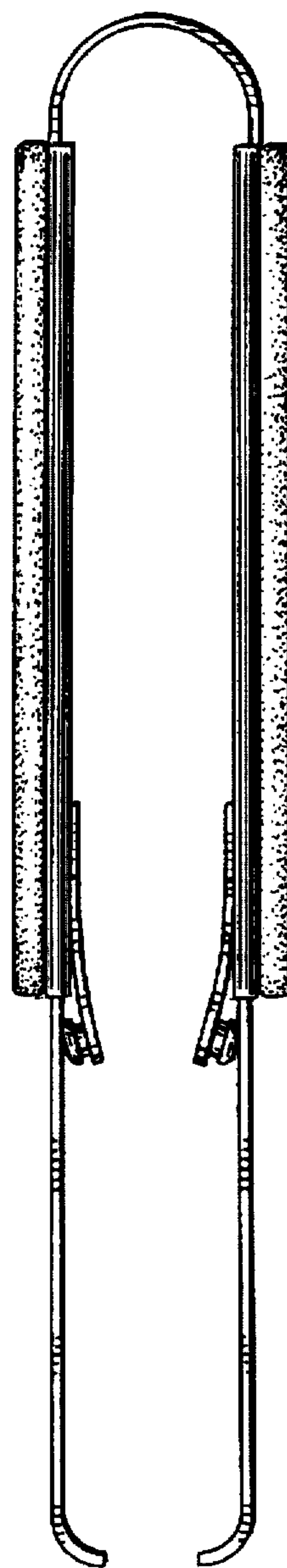

FIG. 24

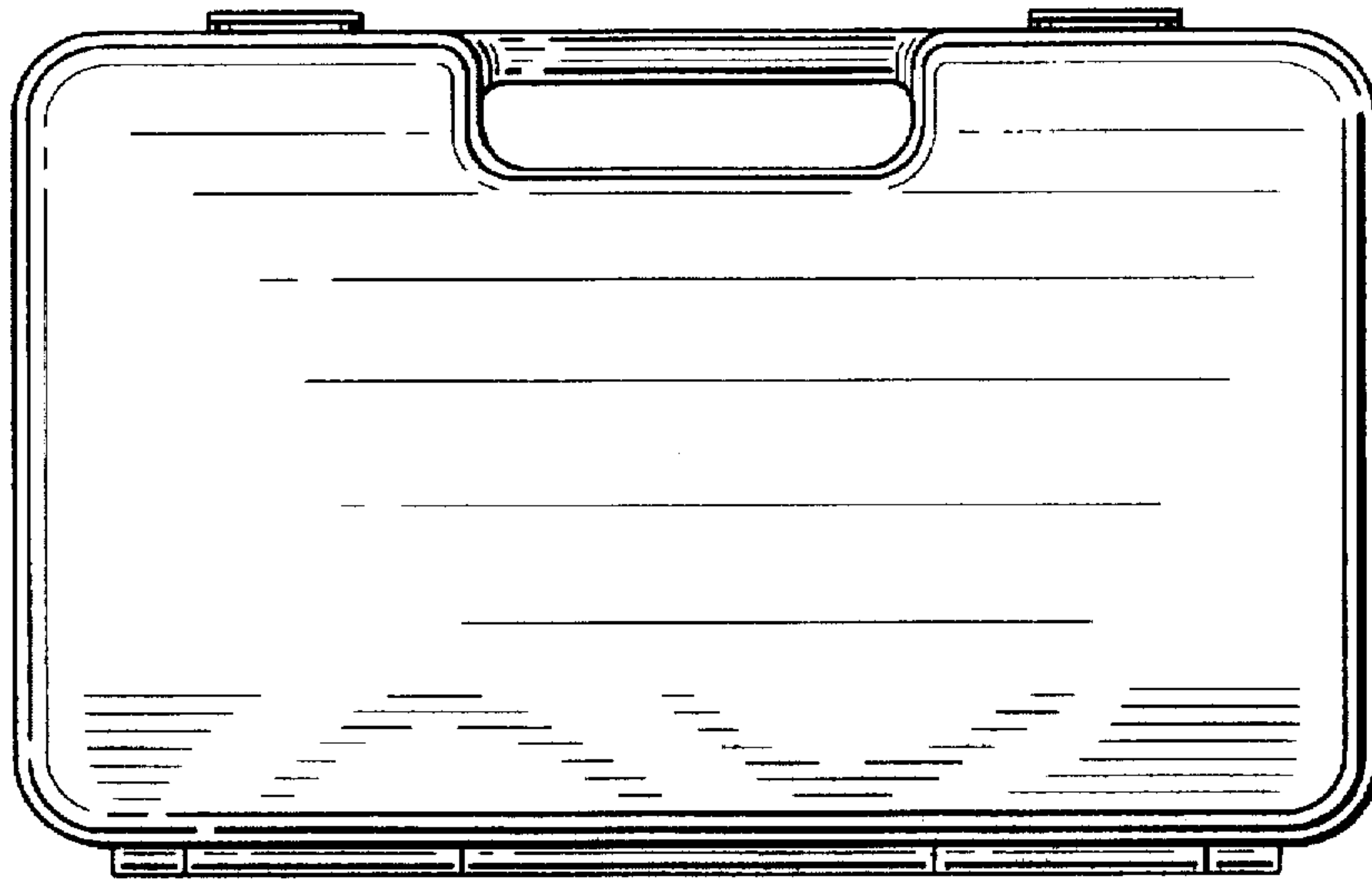

FIG. 25

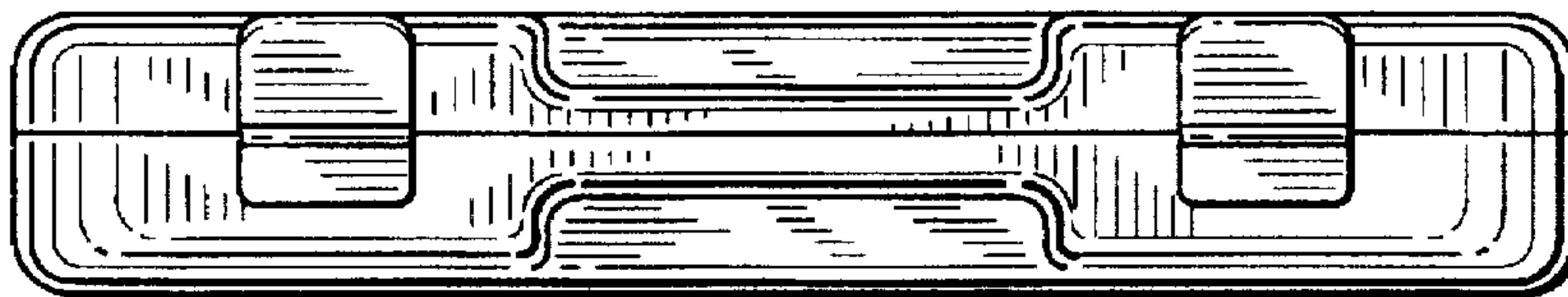

FIG. 26

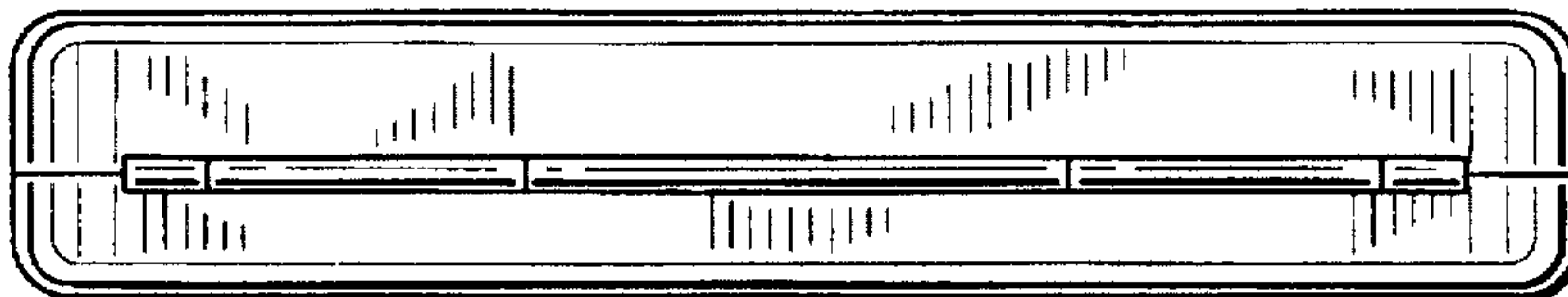

FIG. 27

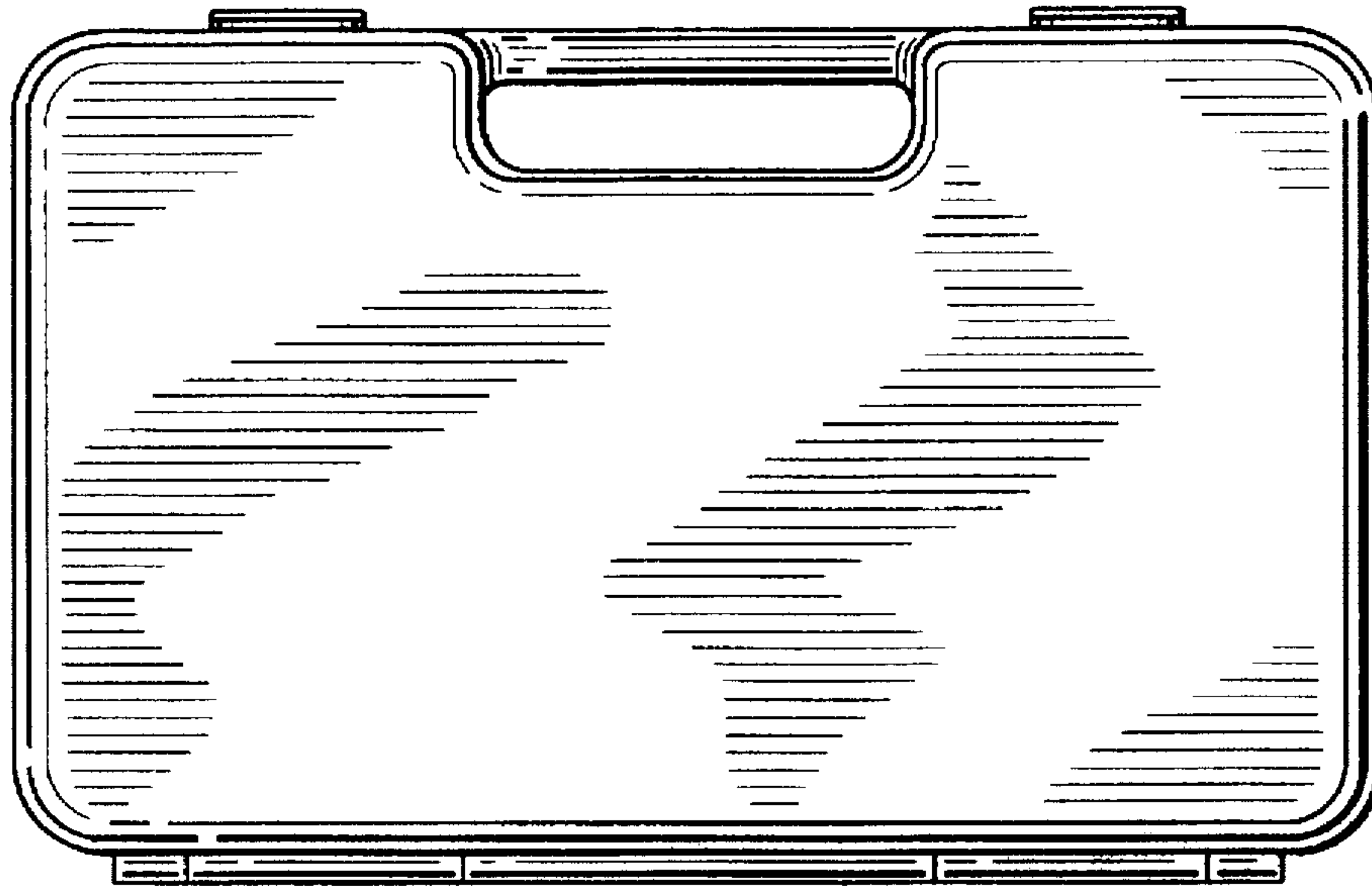

FIG. 28

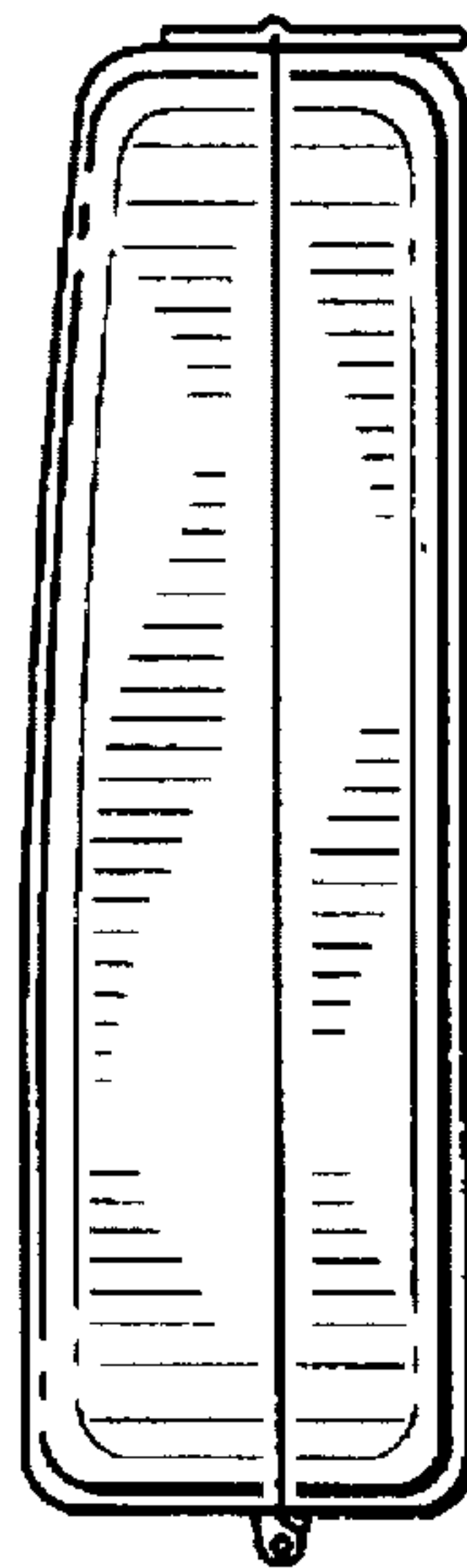

FIG. 29

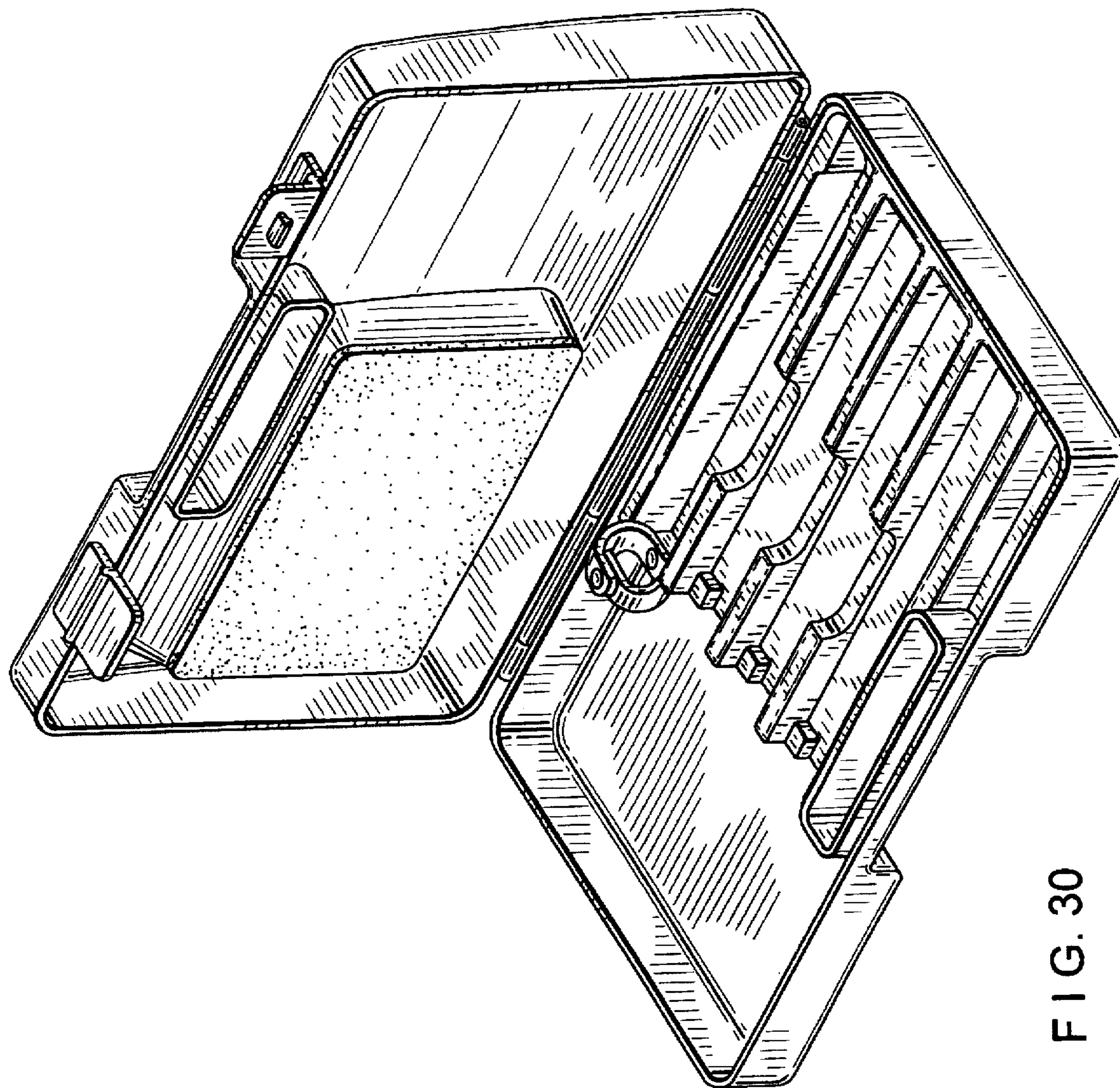

FIG. 30



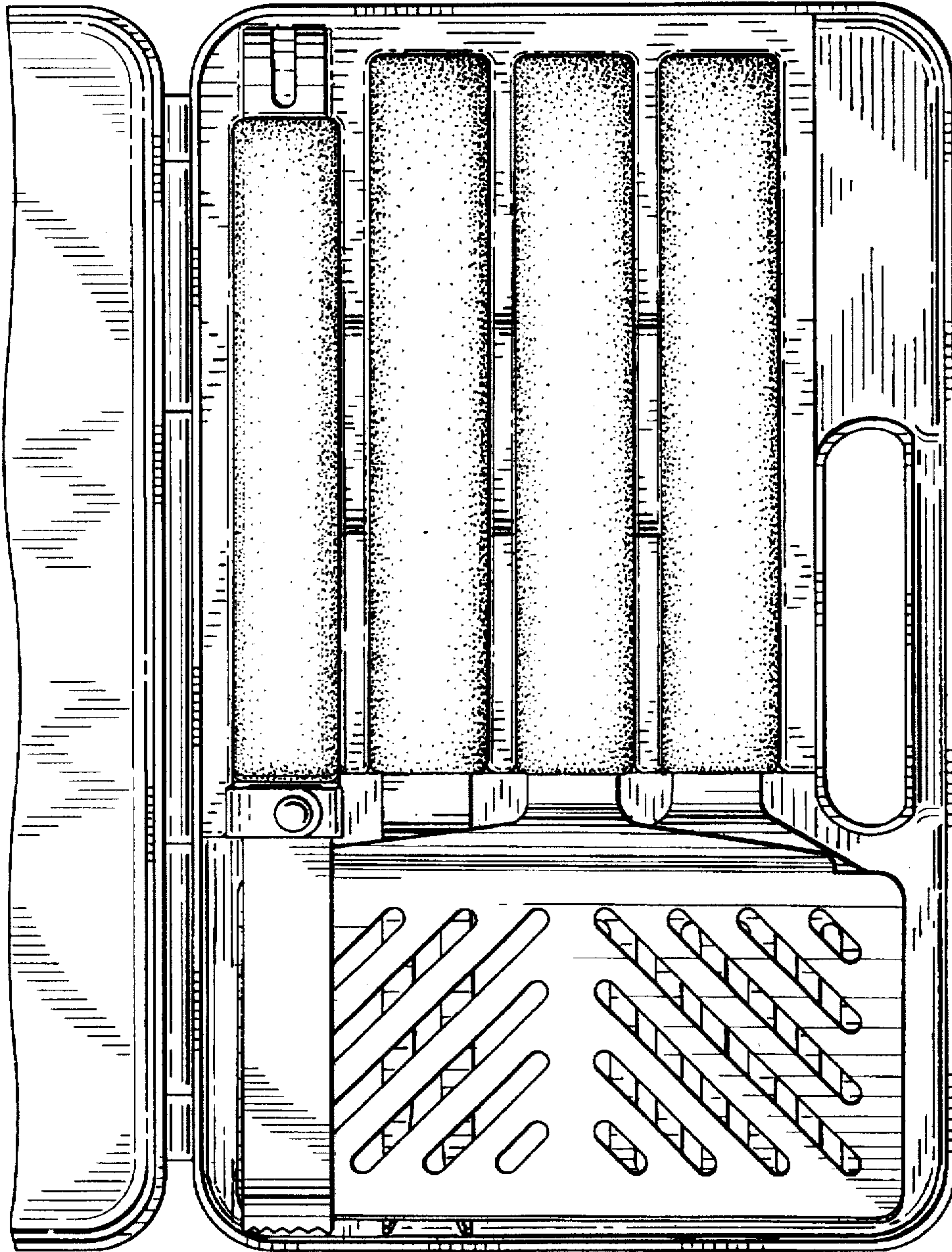

FIG. 31