



US00D392843S

**United States Patent** [19]  
**Mulvihill**

[11] **Patent Number: Des. 392,843**  
[45] **Date of Patent: \*\*Mar. 31, 1998**

[54] **JELLY BEAN DISPENSER**

D. 384,863 10/1997 Danemayer ..... D7/589  
4,948,012 8/1990 Snediker, Sr. et al. .... 221/195

[76] **Inventor: Thomas C. Mulvihill, 59 River Ave.,  
Monmouth Beach, N.J. 07750**

*Primary Examiner*—Terry A. Wallace  
*Attorney, Agent, or Firm*—Charles J. Brodsky

[\*\*] **Term: 14 Years**

[57] **CLAIM**

[21] **Appl. No.: 66,891**

The ornamental design for a jelly bean dispenser, as shown and described.

[22] **Filed: Feb. 25, 1997**

**DESCRIPTION**

[51] **LOC (6) Cl. .... 07-06**

[52] **U.S. Cl. .... D7/589**

[58] **Field of Search ..... D7/589, 590; D20/1,  
D20/7; 221/203, 195, 263-266, 282; 222/185.1,  
450**

FIG. 1 is a perspective view of a jelly bean dispenser showing my new design;  
FIG. 2 is a front elevation view thereof;  
FIG. 3 is a rear elevation view;  
FIG. 4 is a right side elevation view, a left side elevation view being a mirror image;  
FIG. 5 is a top plan view thereof; and,  
FIG. 6 is a bottom plan view.

[56] **References Cited**

**U.S. PATENT DOCUMENTS**

D. 326,983 6/1992 Elmore ..... D7/589

**1 Claim, 5 Drawing Sheets**

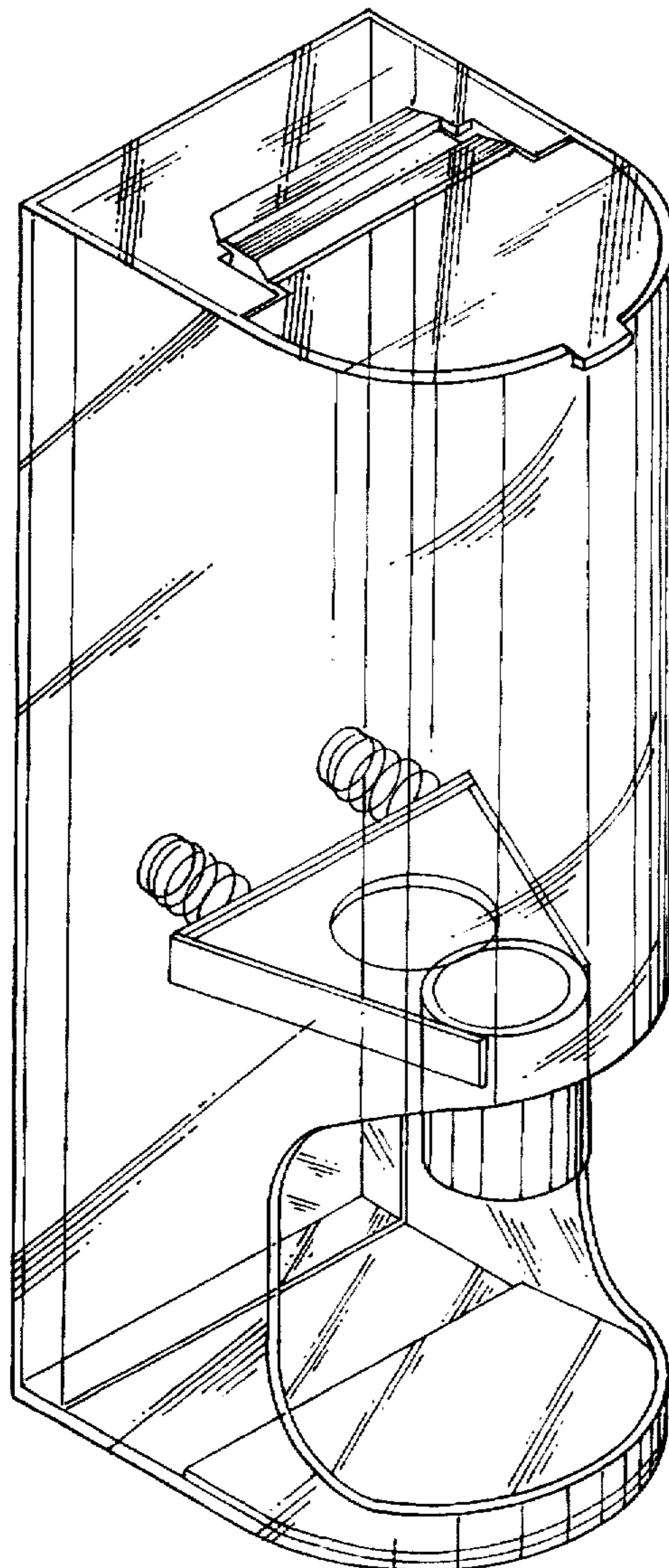

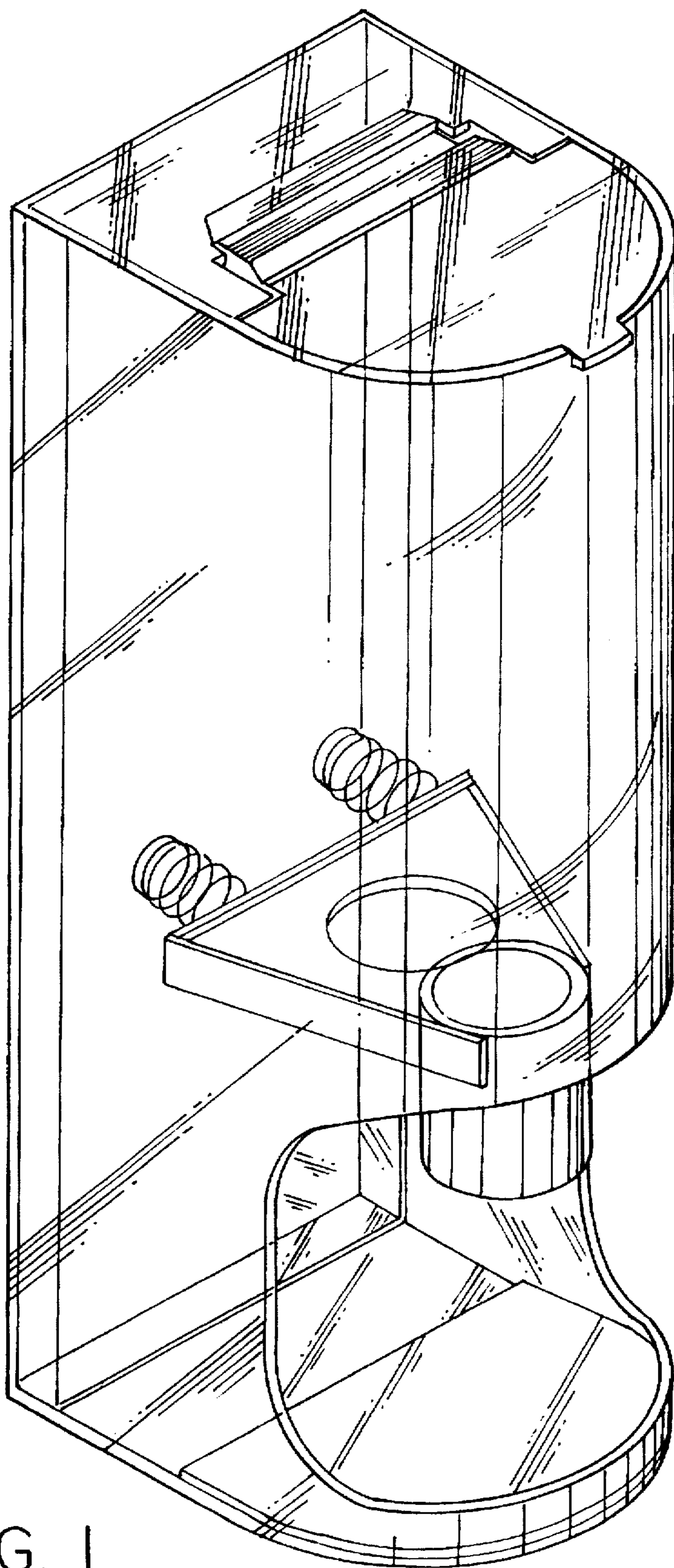

FIG. 1

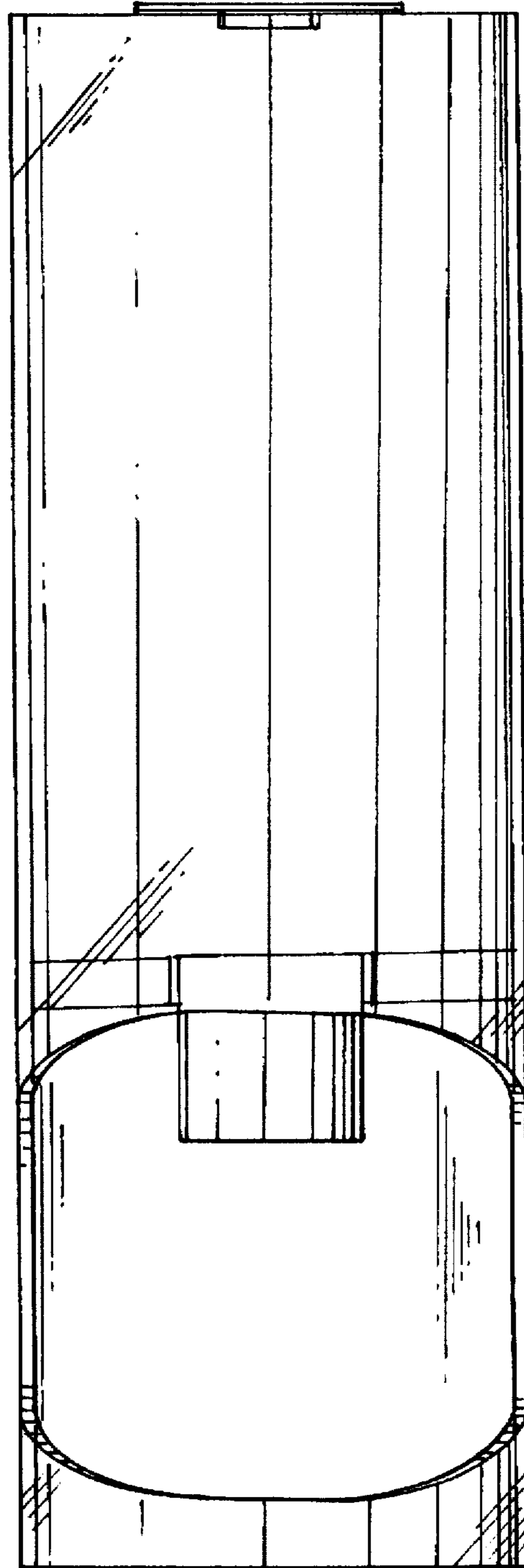

FIG. 2

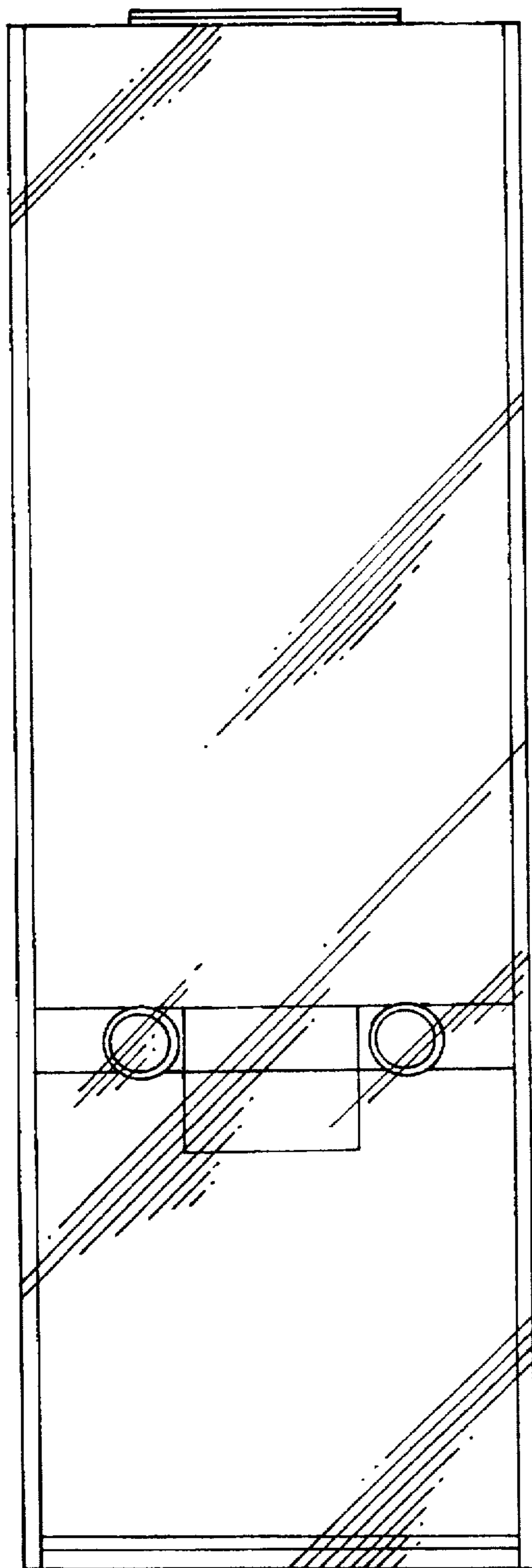

FIG. 3

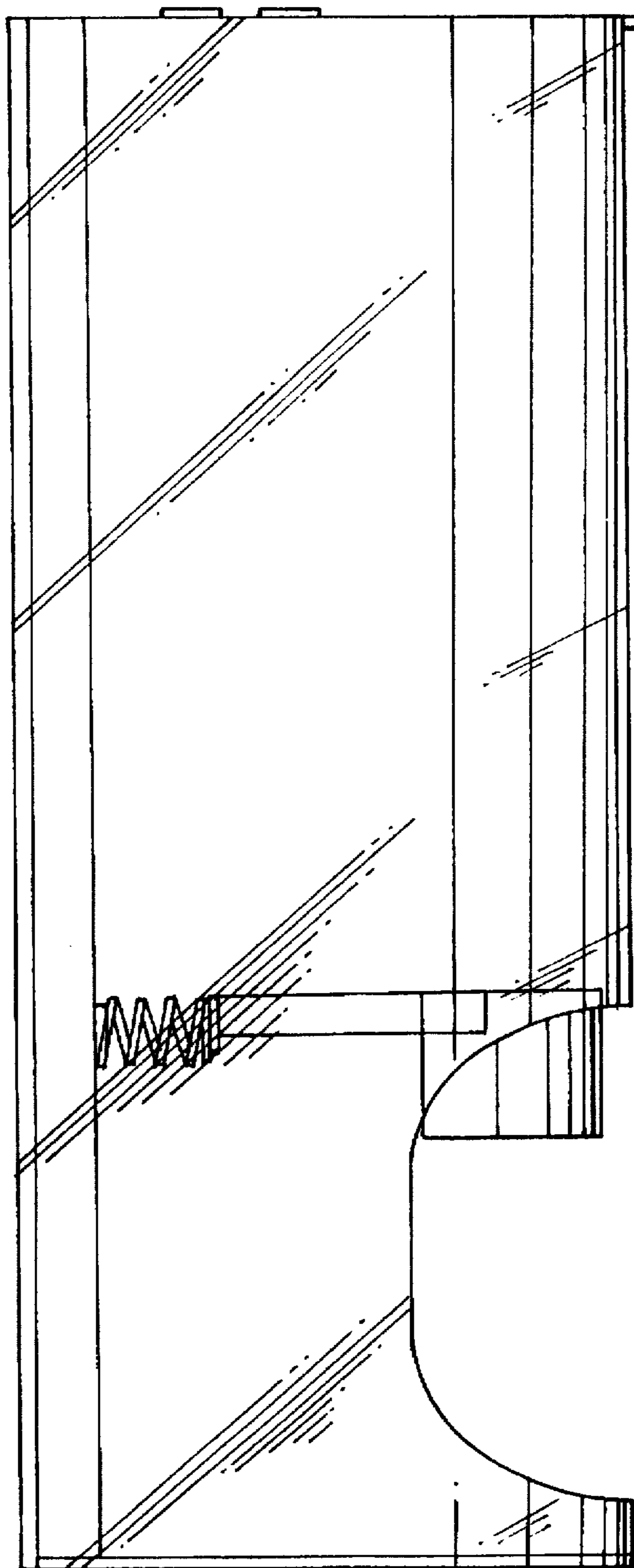

FIG. 4

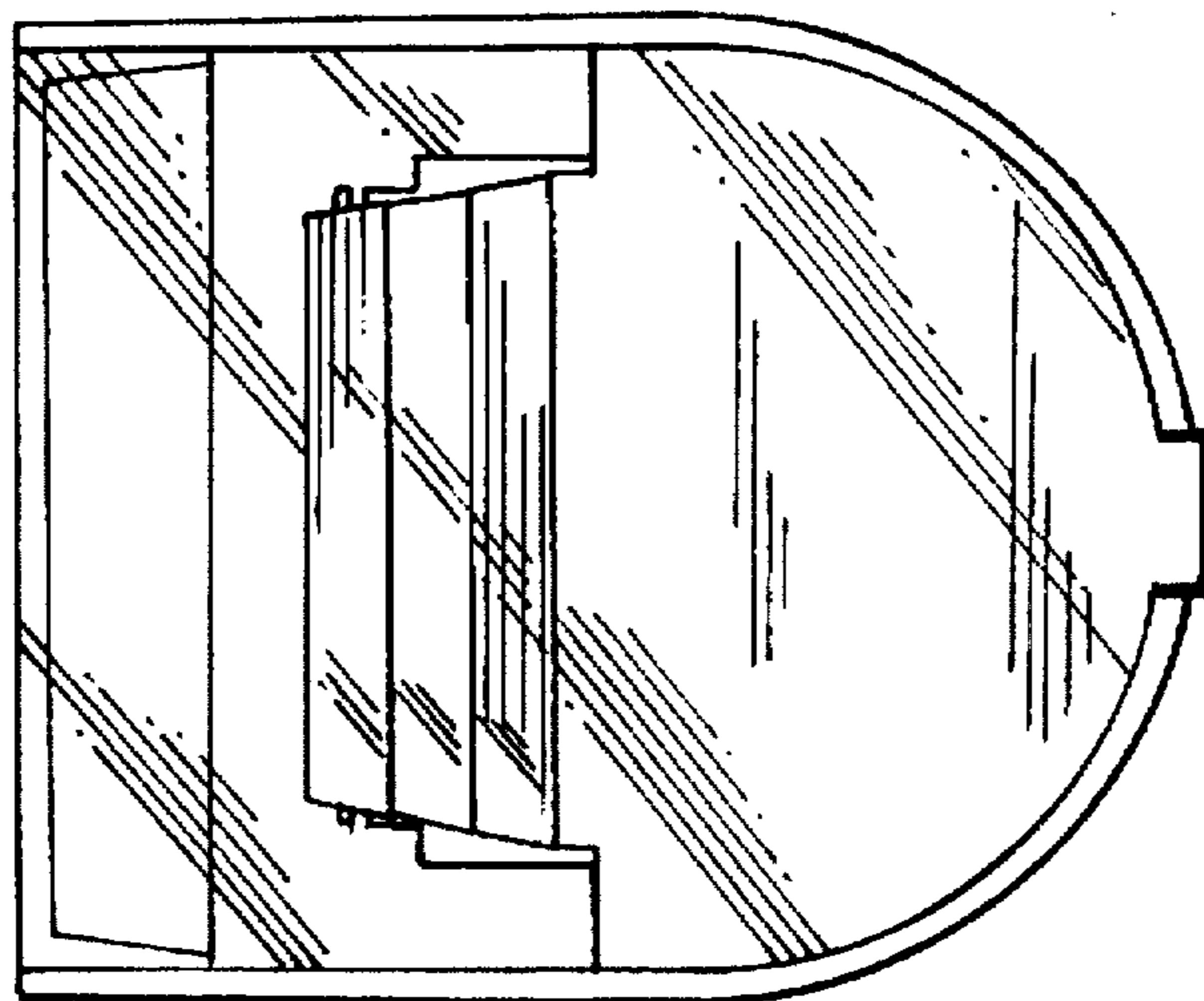

FIG. 5

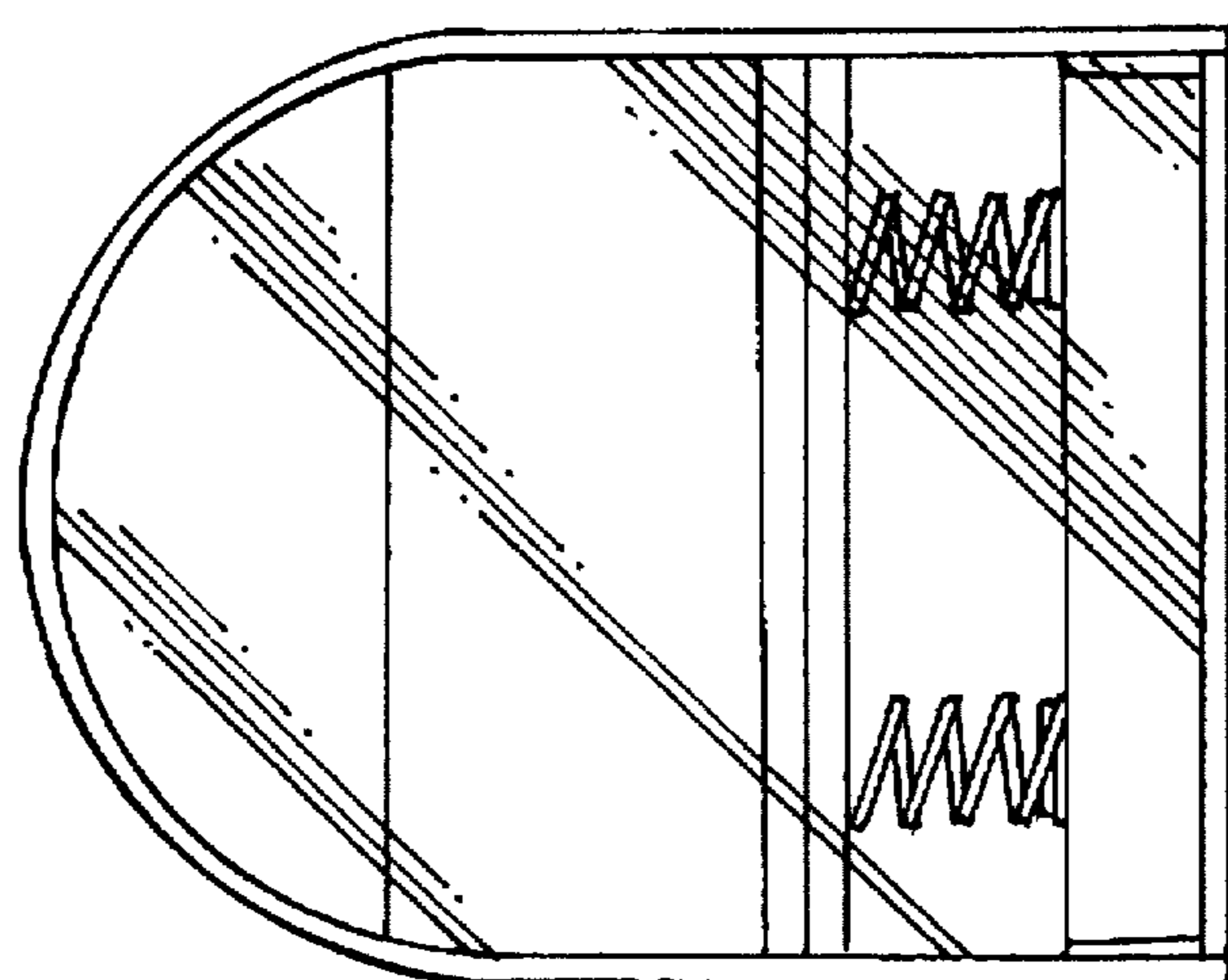

FIG. 6