



US00D392826S

# United States Patent [19]

Paikos et al.

[11] Patent Number: Des. 392,826

[45] Date of Patent: \*\*Mar. 31, 1998

[54] HAMMER HOLDER

4,143,845 3/1979 Harris ..... 248/302 X  
4,421,238 12/1983 Patton ..... 211/13

[76] Inventors: **George P. Paikos**, 27795 Avenue Hopkins, Valencia, Calif. 91355;  
**Michael Chien-Fang Chen**, No. 17 Kung 6 Road, Lin-Kou 2nd Industrial Park, Taipei, Hsien, Taiwan

### OTHER PUBLICATIONS

Photographs of specimen of a hammer holder manufactured by Ho Yin Yee of Taiwan and distributed in the United States—Dated Prior to Filing Date.

[\*\*] Term: 14 Years

*Primary Examiner*—Brian N. Vinson  
*Attorney, Agent, or Firm*—David Weiss

[21] Appl. No.: 60,251

[57] CLAIM

[22] Filed: Sep. 25, 1996

The ornamental design for a hammer holder, as shown.

[51] LOC (6) Cl. .... 08-08

### DESCRIPTION

[52] U.S. Cl. .... D6/566

[58] Field of Search ..... D6/512, 552, 553, D6/566, 567; D8/349, 354, 356, 367, 370, 373; 211/13, 30, 70.5, 70.6, 86, 87, 181; 248/302, 304, 309.1, 312

FIG. 1 is a front, side perspective view of a hammer holder showing our new design;  
FIG. 2 is a left side elevation view thereof, the right side being a mirror image;  
FIG. 3 is a top plan view thereof;  
FIG. 4 is a bottom plan view thereof;  
FIG. 5 is a front elevation view thereof; and  
FIG. 6 is a rear elevation view thereof.

### [56] References Cited

#### U.S. PATENT DOCUMENTS

D. 153,957 5/1949 Linnard ..... D6/566  
D. 281,221 11/1985 Edmiston ..... D8/373 X  
D. 301,406 6/1989 Barbieri et al. .... D6/566

1 Claim, 1 Drawing Sheet

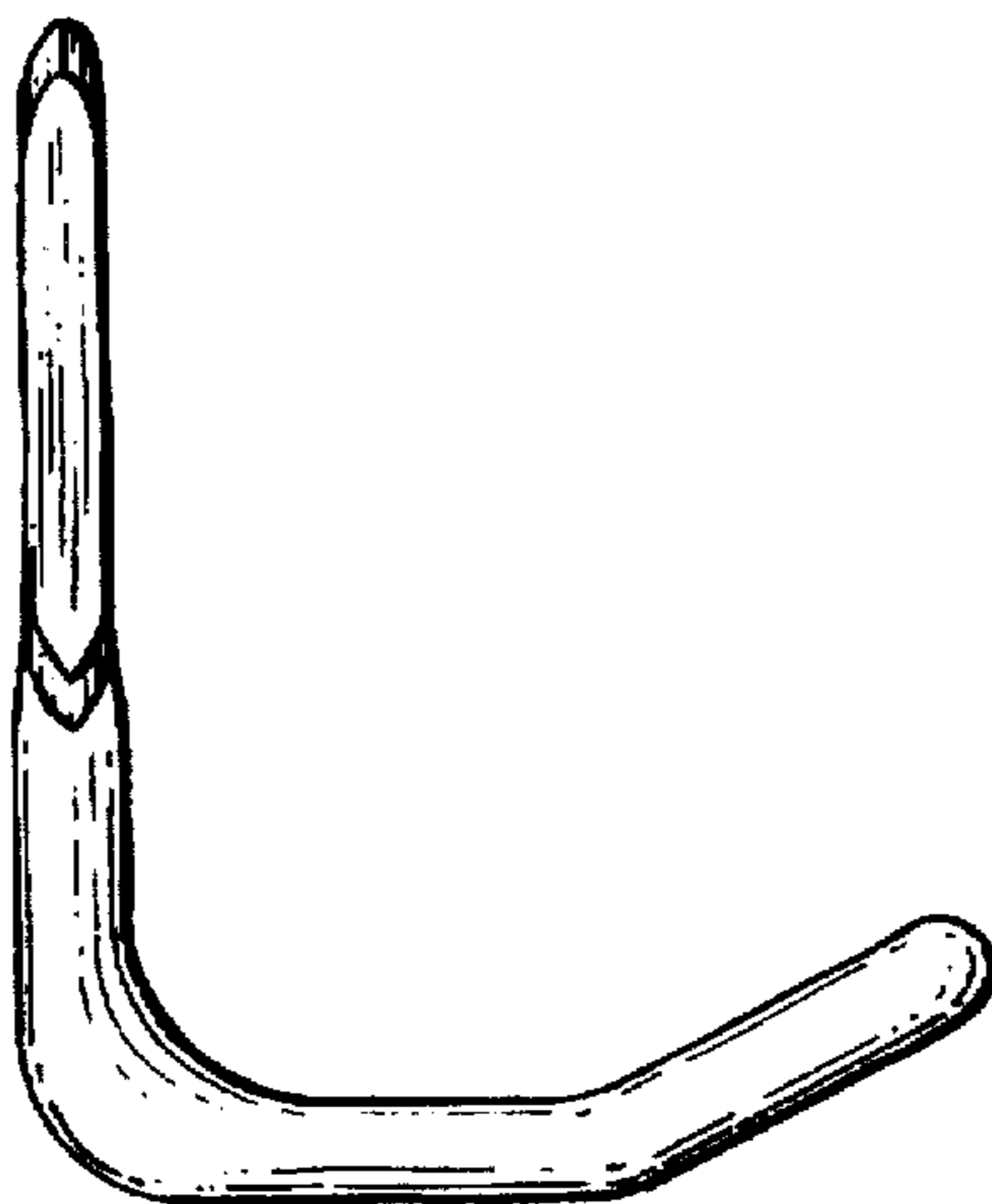
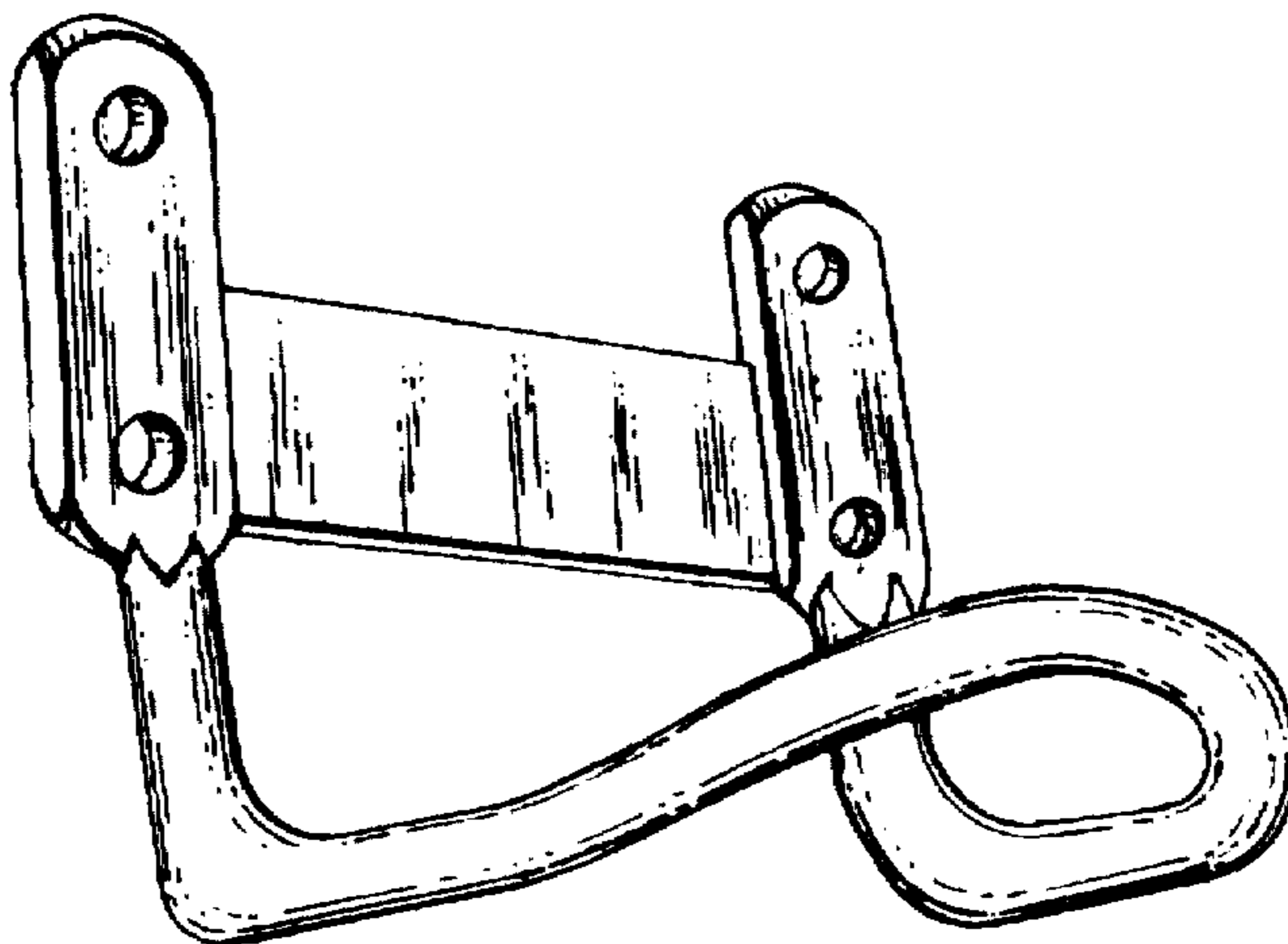

Fig. 1.

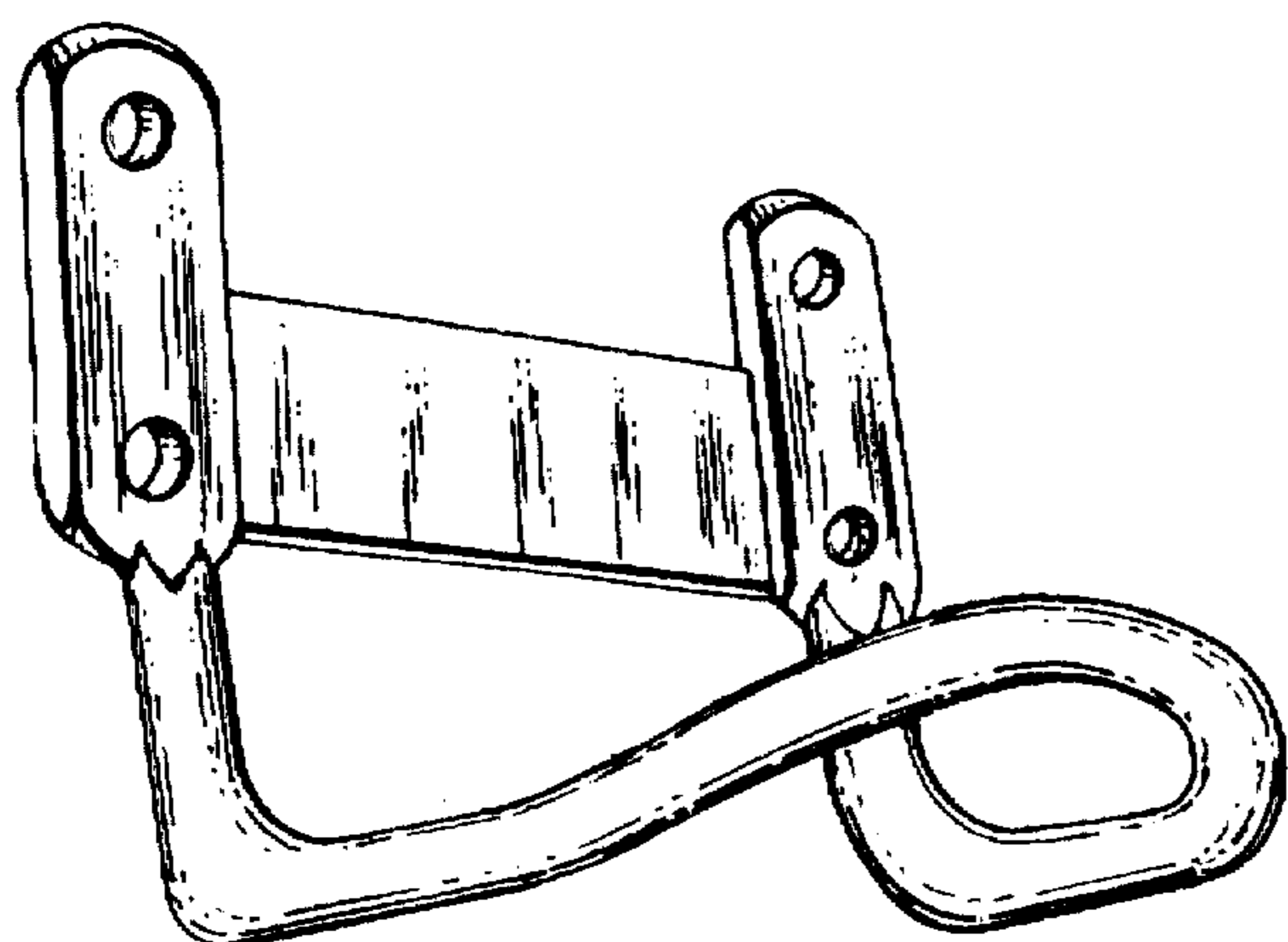

Fig. 2.

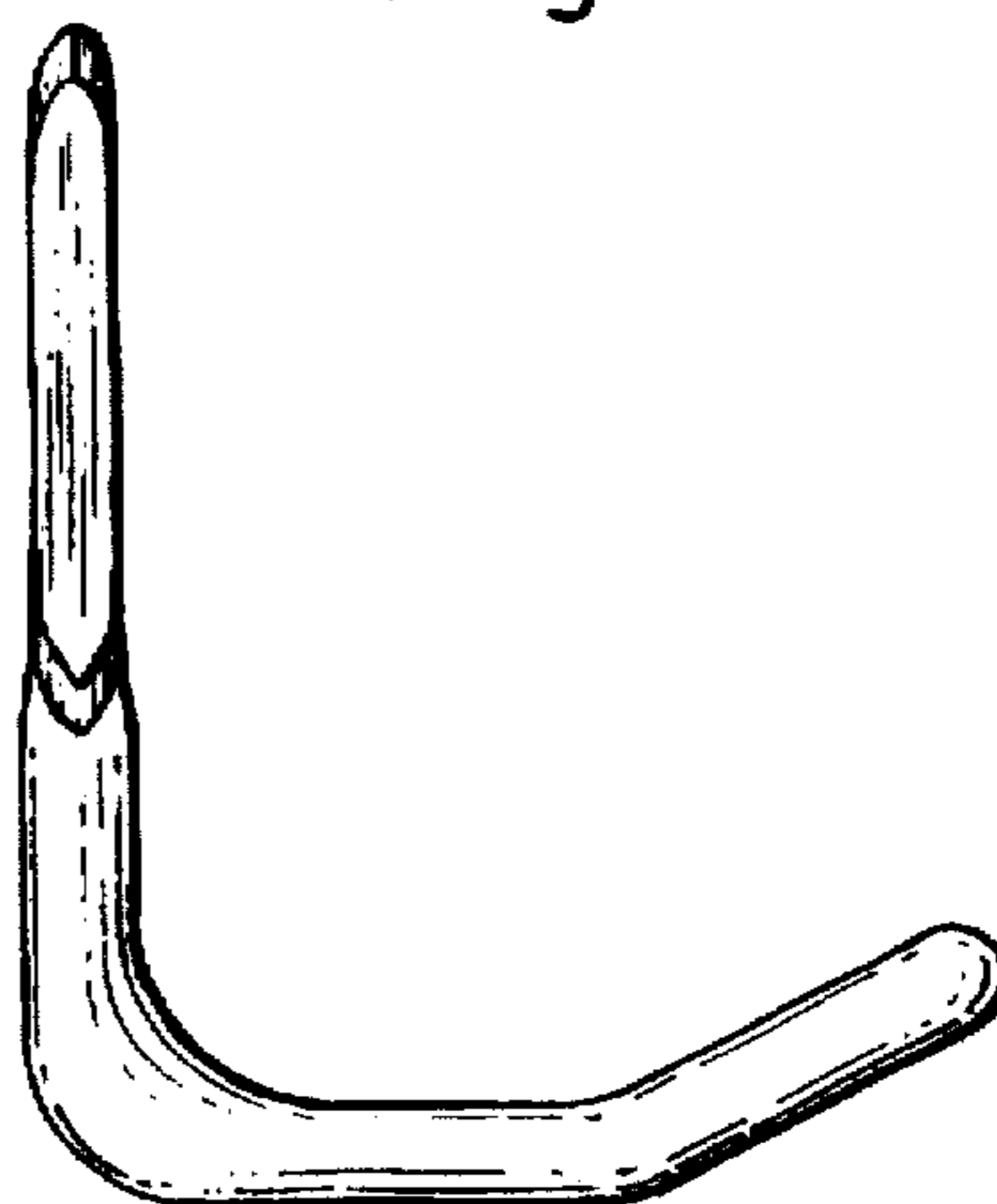

Fig. 3.

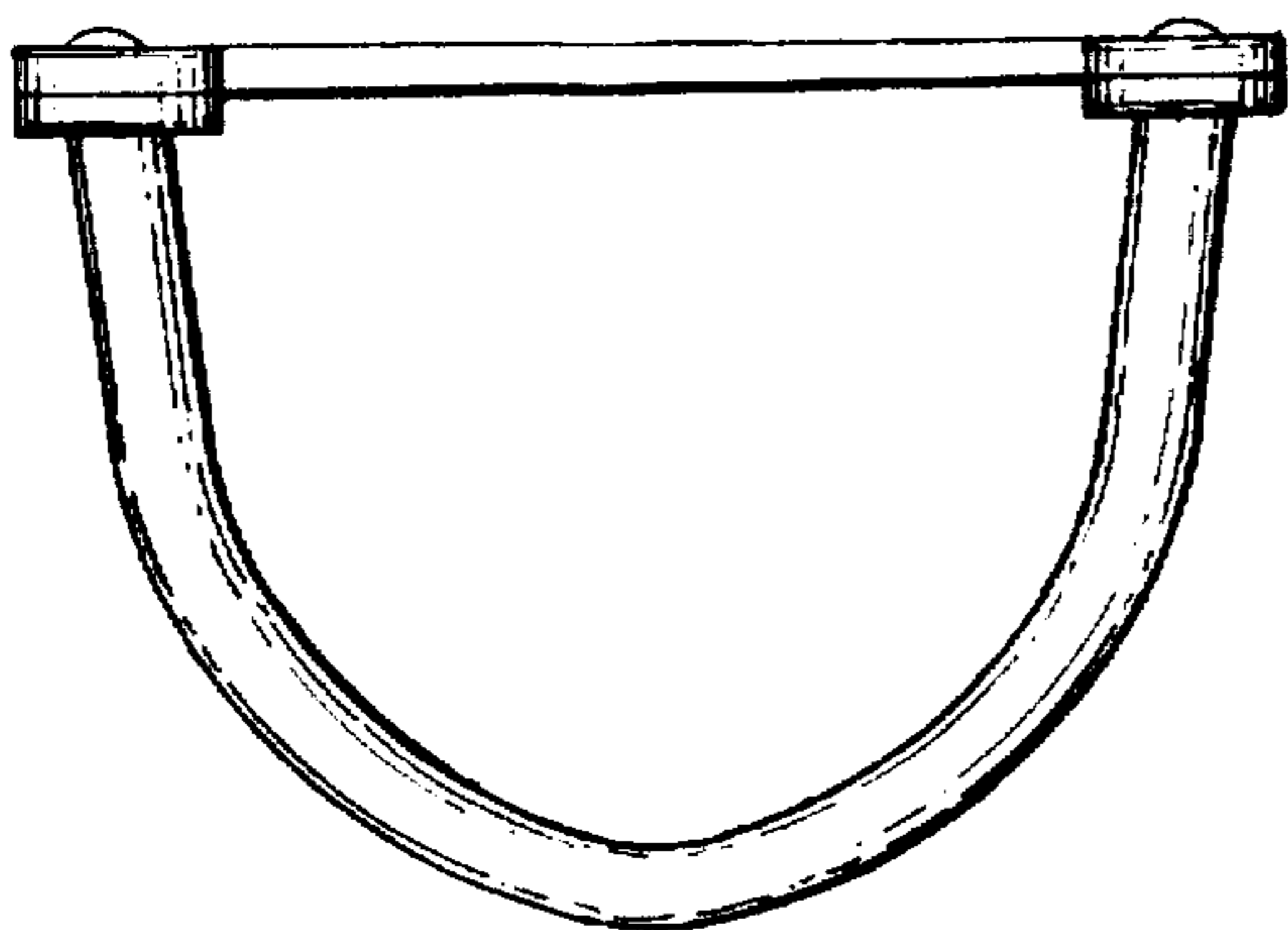

Fig. 4.

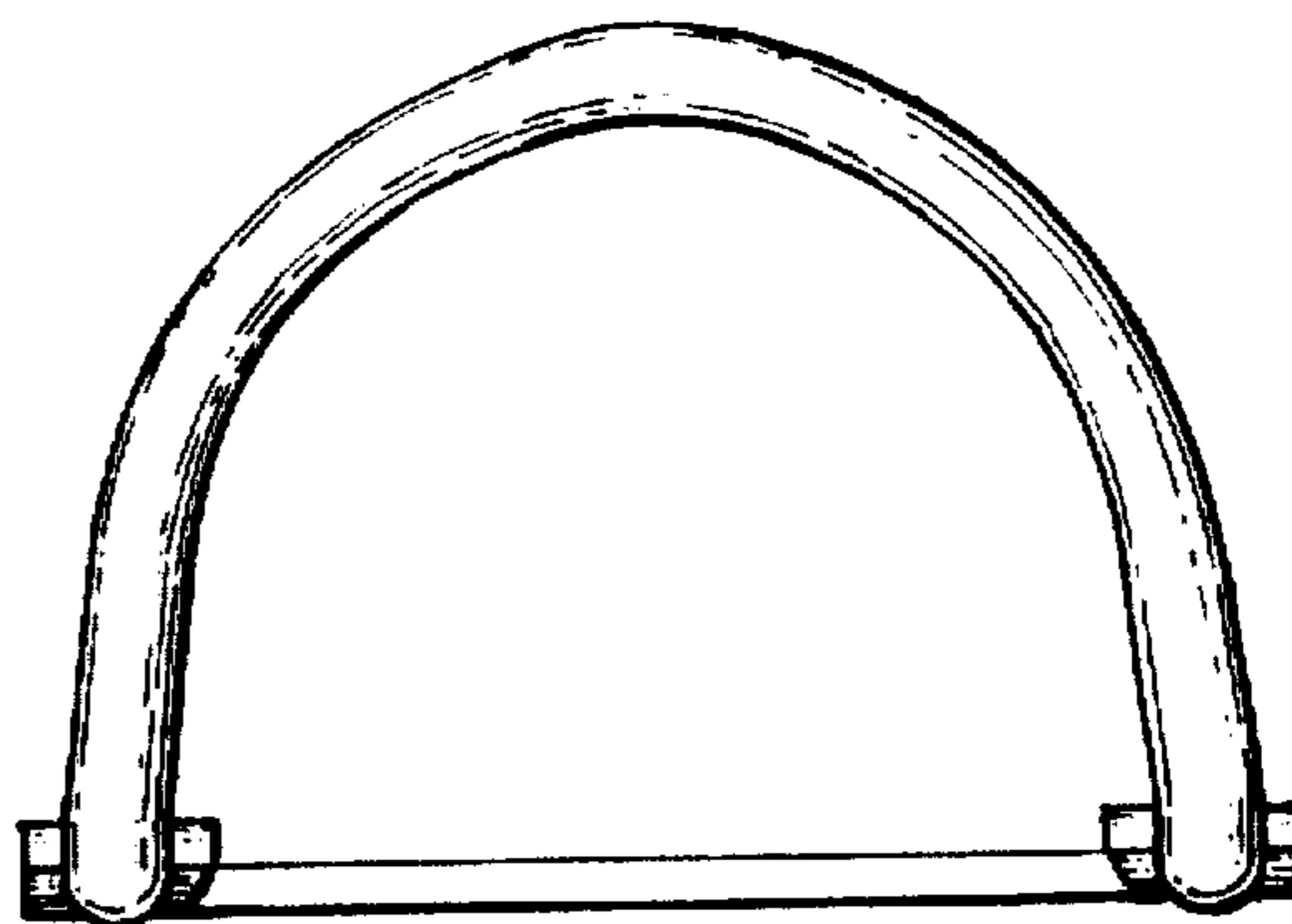

Fig. 5.

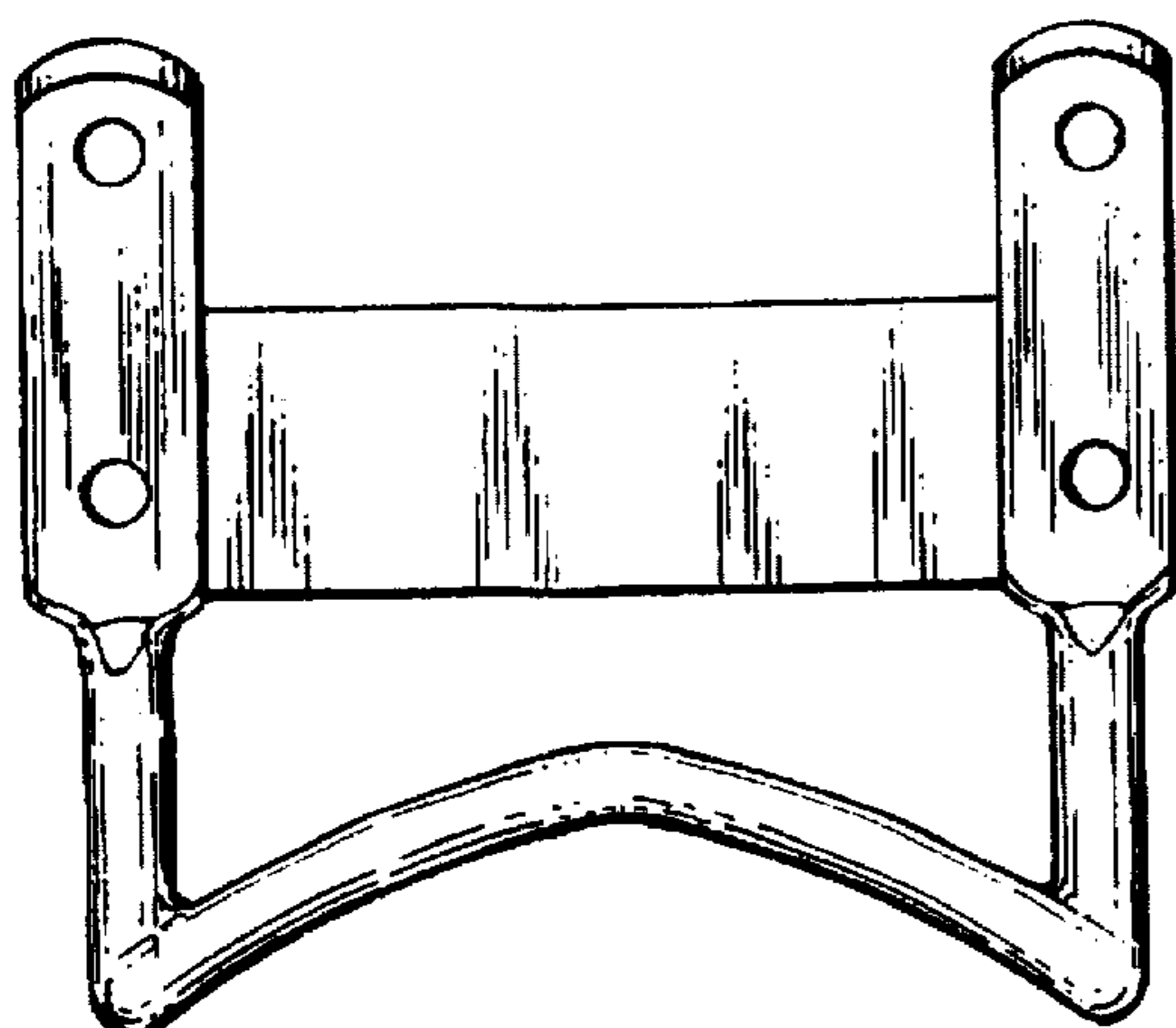

Fig. 6.

