



US00D392809S

United States Patent [19]

[11] Patent Number: Des. 392,809

Natuzzi et al.

[45] Date of Patent: **Mar. 31, 1998

[54] SEAT

[75] Inventors: Pasquale Natuzzi, Santeramo In Colle; Arcangelo Scarati, Talsano, both of Italy

[73] Assignee: Industrie Natuzzi, SpA, Bari, Italy

[**] Term: 14 Years

[21] Appl. No.: 64,390

[22] Filed: Dec. 30, 1996

[51] LOC (6) Cl. 06-01

[52] U.S. Cl. D6/381; D6/334

[58] Field of Search D6/334, 335, 364, D6/371, 373, 381, 500, 501, 502; 297/232

[56] References Cited

U.S. PATENT DOCUMENTS

D. 305,184	12/1989	Coley	D6/381
D. 326,022	5/1992	Gera	D6/381
D. 353,061	12/1994	Natuzzi et al.	D6/381
D. 353,724	12/1994	Lowman	D6/381
D. 367,180	2/1996	Natuzzi et al.	D6/381
D. 369,479	5/1996	Natuzzi et al.	D6/381
D. 373,484	9/1996	Natuzzi et al.	D6/381
D. 373,485	9/1996	Natuzzi et al.	D6/381

OTHER PUBLICATIONS

- Natuzzi Model 175, Apr., 1986, at International Home Furnishings Market in High Point, North Carolina.
- Natuzzi Model 499, Apr., 1989, at International Home Furnishings Market in High Point, North Carolina.
- Natuzzi Model 604/605, Oct., 1987, at International Home Furnishings Market in High Point, North Carolina.
- Natuzzi Model 723, Oct., 1989, at International Home Furnishings Market in High Point, North Carolina.
- Natuzzi Model 782, Oct., 1990, at International Home Furnishings Market in High Point, North Carolina.
- Natuzzi Model 848, Apr., 1991, at International Home Furnishings Market in High Point, North Carolina.
- Natuzzi Model 990, Oct., 1992, at International Home Furnishings Market in High Point, North Carolina.

- Natuzzi Model 1039, Apr., 1993, at International Home Furnishings Market in High Point, North Carolina.
- Natuzzi Model 1056, Apr., 1993, at International Home Furnishings Market in High Point, North Carolina.
- Natuzzi Model 1114, Oct., 1993, at International Home Furnishings Market in High Point, North Carolina.
- Natuzzi Model 1117, Jan., 1994, at International Home Furnishings Market in High Point, North Carolina.
- Natuzzi Model 1132, Jan., 1994, at International Home Furnishings Market in High Point, North Carolina.
- Natuzzi Model 1140, Apr., 1994, at International Home Furnishings Market in High Point, North Carolina.
- Natuzzi Model 1183, Apr., 1994, at International Home Furnishings Market in High Point, North Carolina.
- Natuzzi Model 1188, Apr., 1994, at International Home Furnishings Market in High Point, North Carolina.
- Natuzzi Model 1190, Apr., 1994, at International Home Furnishings Market in High Point, North Carolina.
- Natuzzi Model 1321, Apr., 1995, at International Home Furnishings Market in High Point, North Carolina.
- Natuzzi Model 1349, Sep., 1995, at International Home Furnishings Market in High Point, North Carolina.

Primary Examiner—Gary D. Watson
Attorney, Agent, or Firm—Bell Seltzer Intellectual Property Law Group Alston & Bird, LLP

[57] CLAIM

The ornamental design for a seat, as shown and described.

DESCRIPTION

FIG. 1 is a front perspective view of a seat showing our new design in the form of a sofa;
 FIG. 2 is a front elevational view thereof;
 FIG. 3 is a top plan view thereof;
 FIG. 4 is a right side elevational view, the left side being a mirror image thereof;
 FIG. 5 is a rear perspective view thereof;
 FIG. 6 is a front elevational view of a seat showing our new design in the form of a loveseat; and,
 FIG. 7 is front elevational view of a seat showing our new design in the form of a chair.
 The broken lines shown herein are for illustrative purposes only and form no part of the claimed design.
 The rear views of FIGS. 6 and 7 are like FIG. 5, the difference being a matter of length.

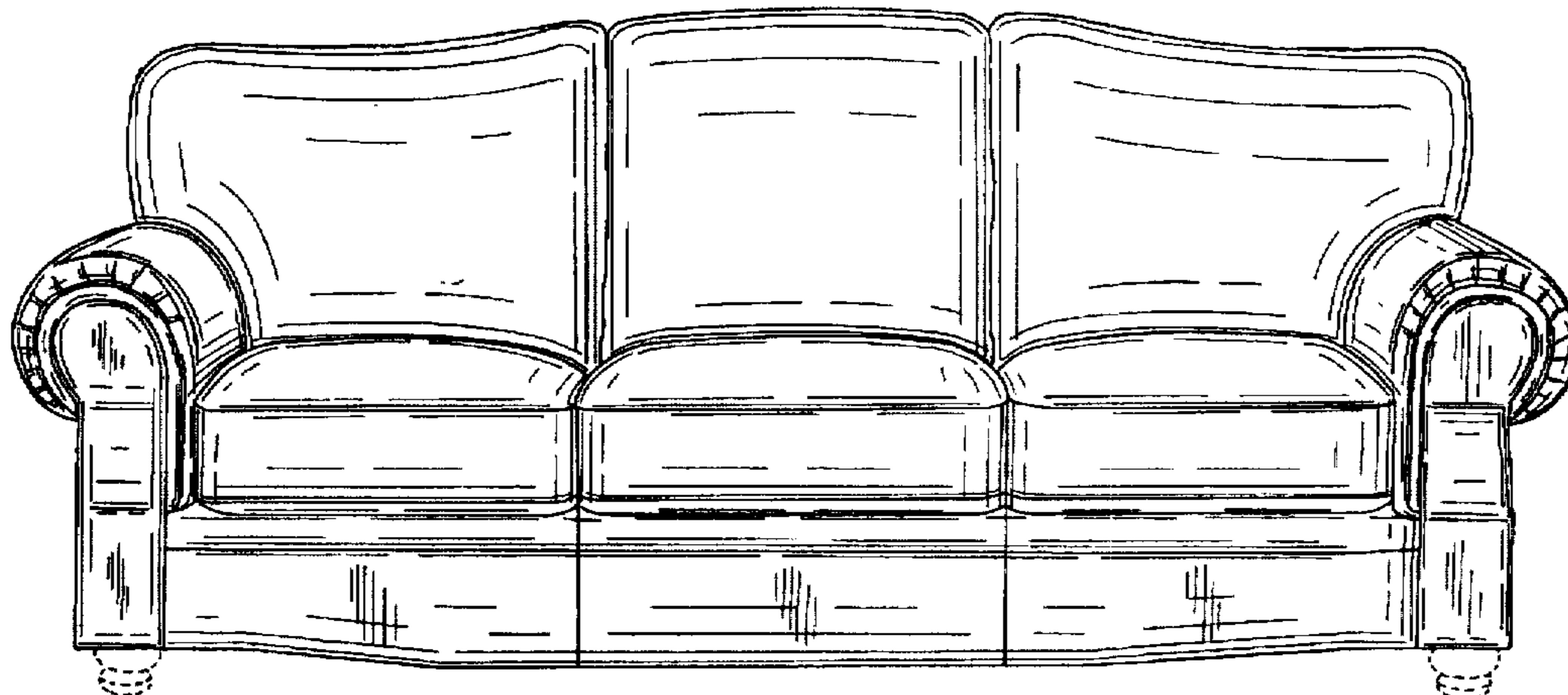

The end views of FIGS. 6 and 7 are like FIG. 4.
FIGS. 1 and 5 have been shown on an enlarged scale with
respect to the other views.

1 Claim, 3 Drawing Sheets

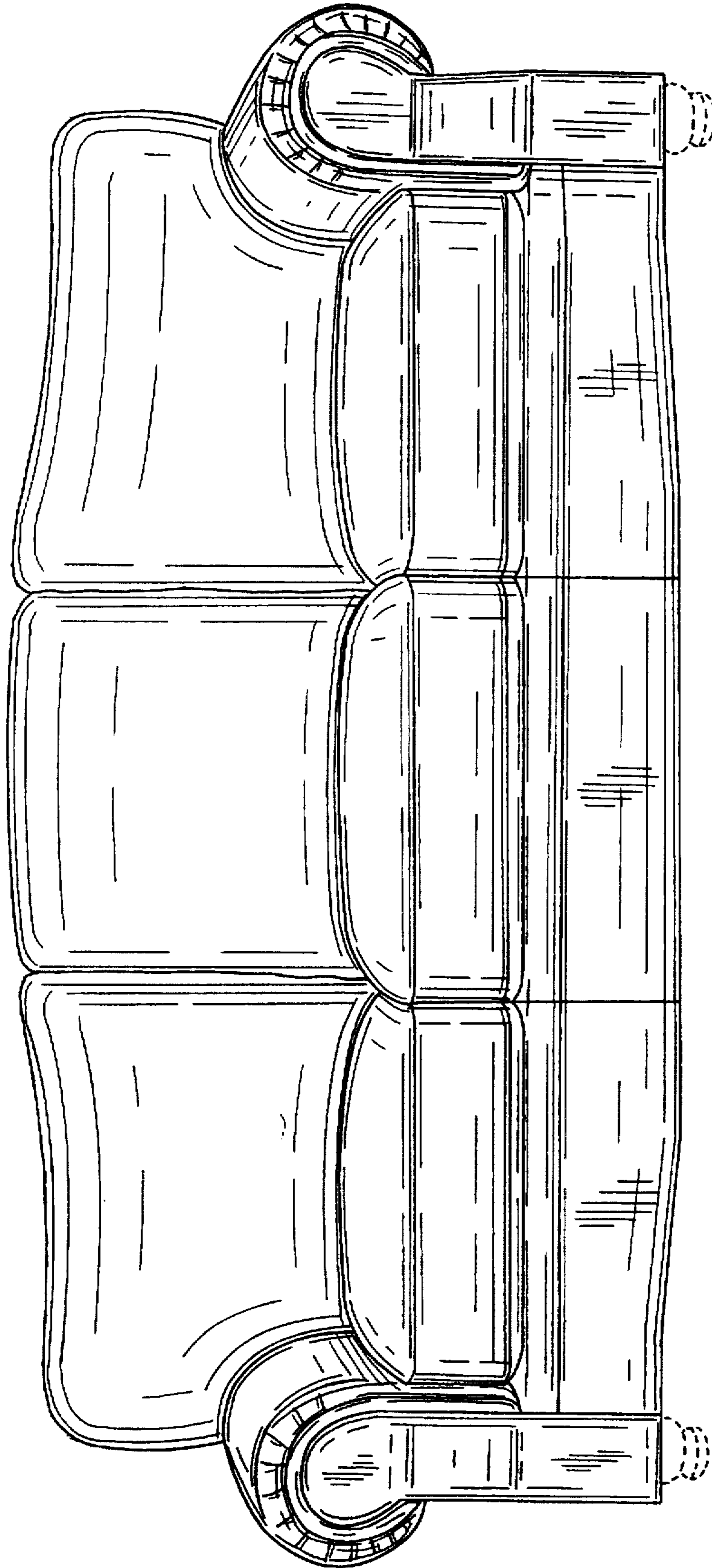

FIG. 1.

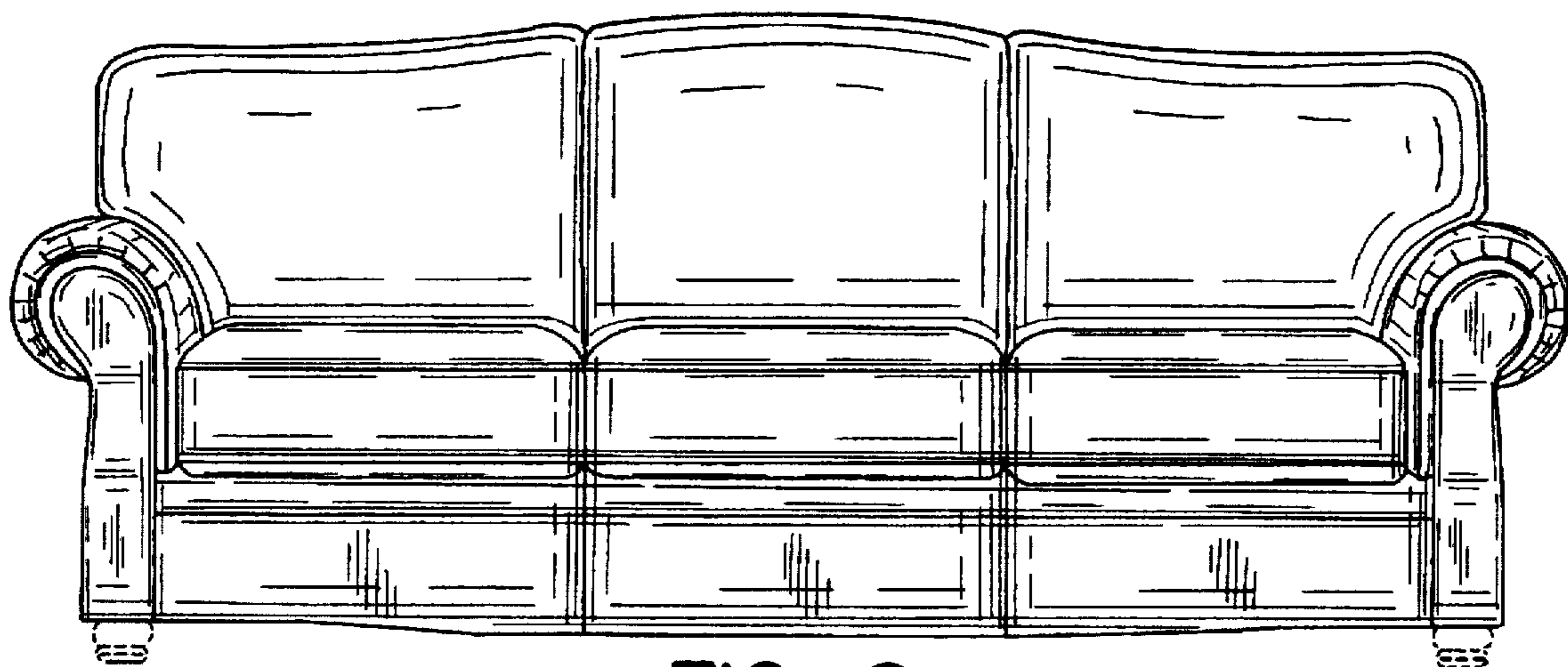

FIG. 2.

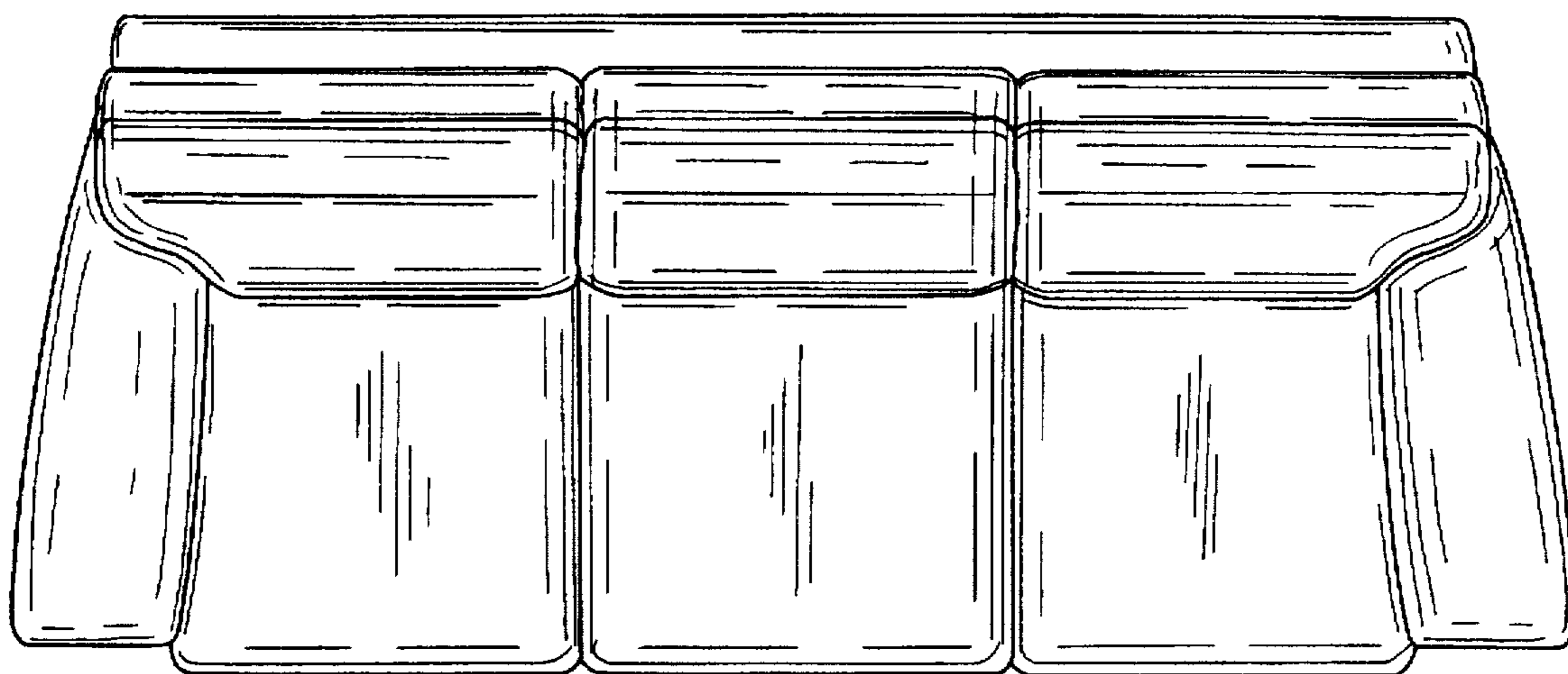

FIG. 3.

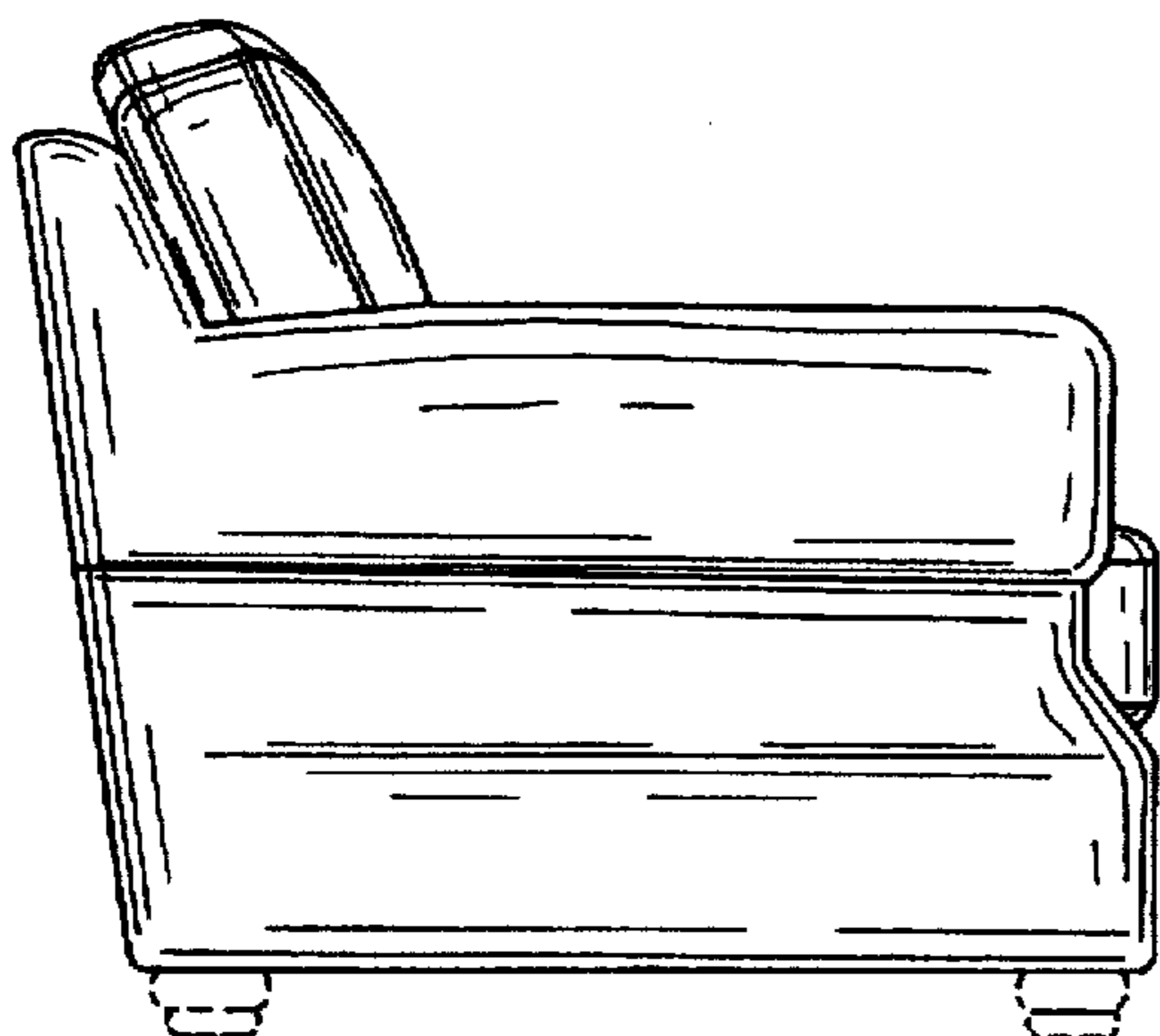

FIG. 4.

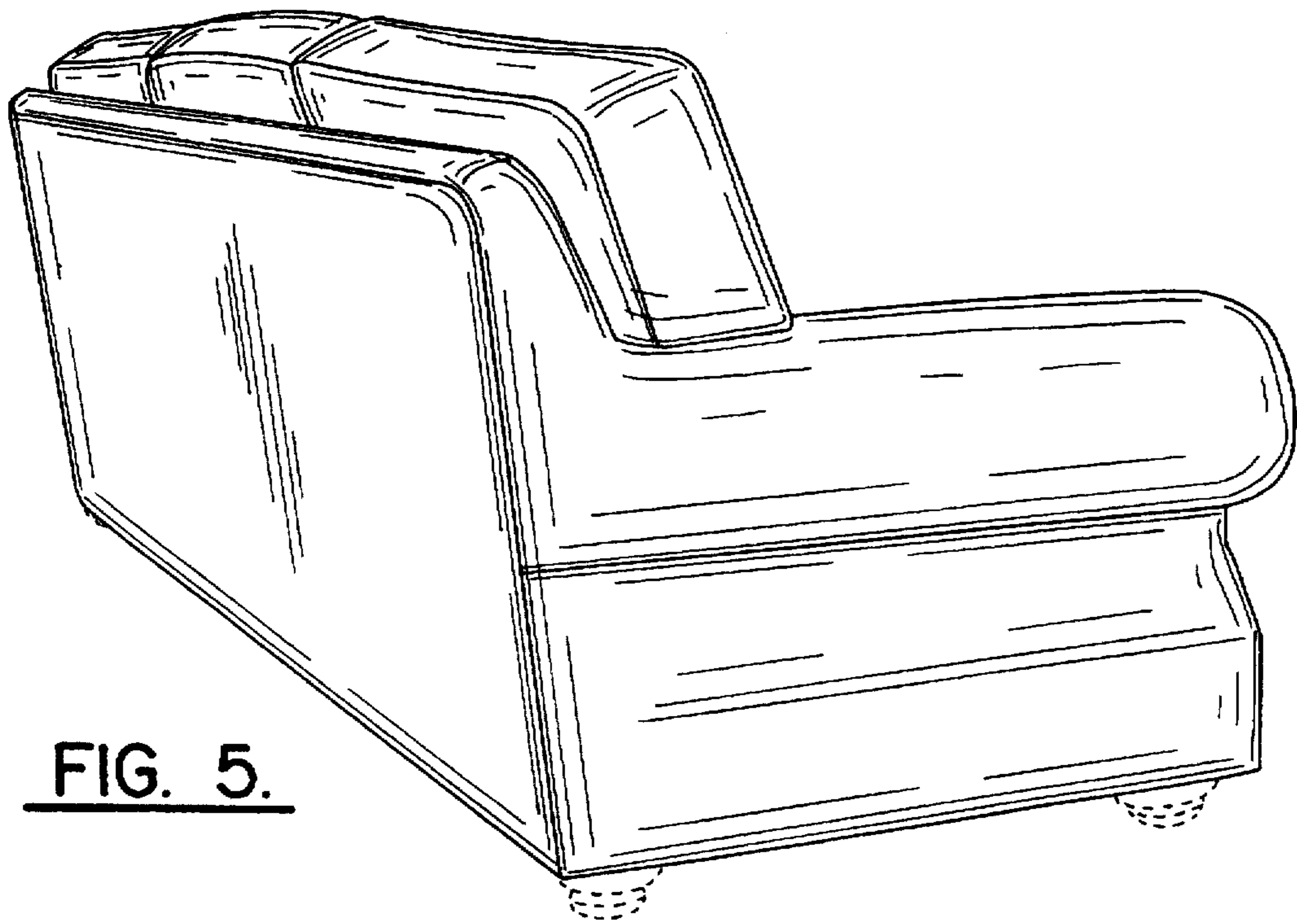

FIG. 5.

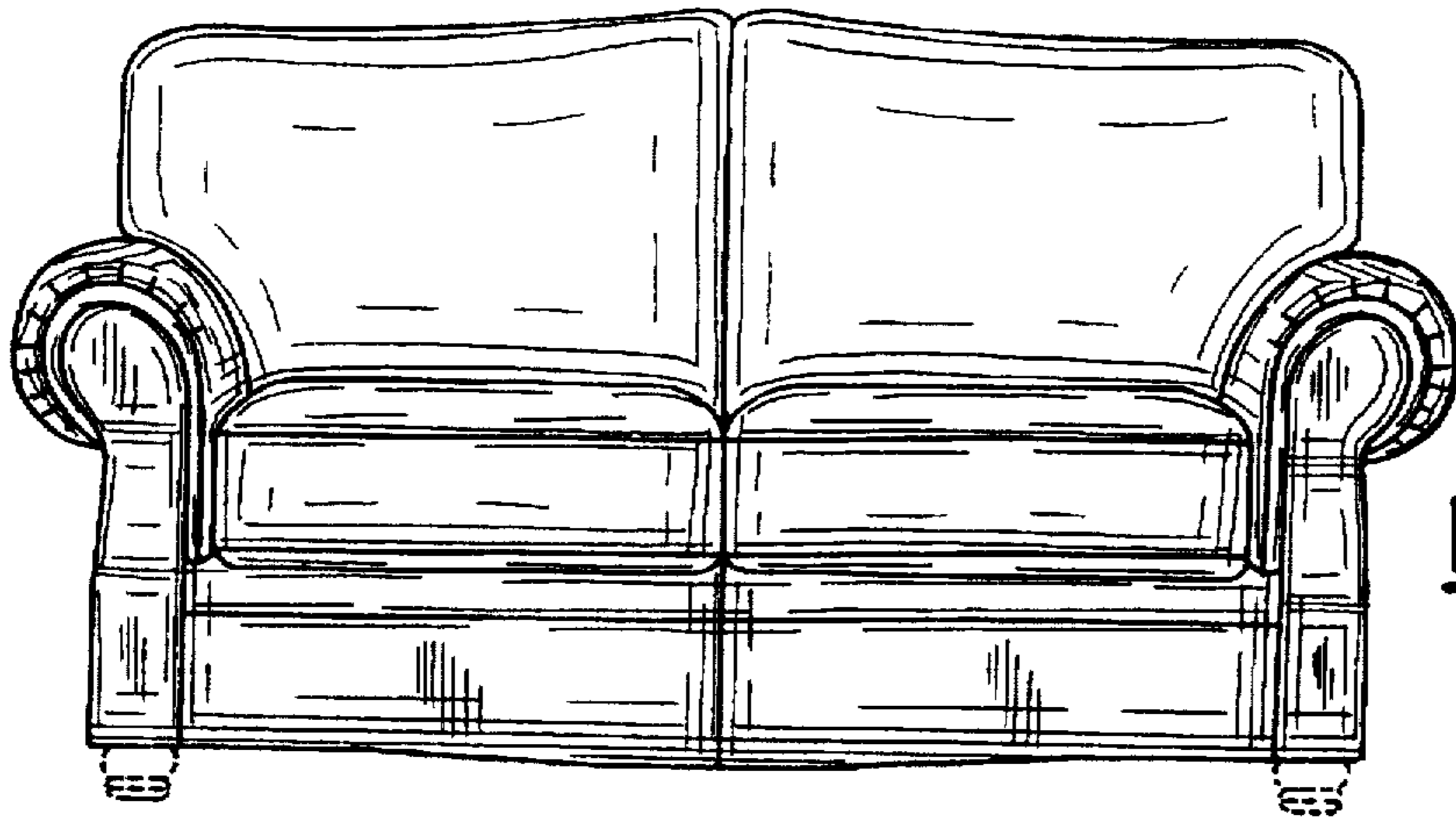

FIG. 6.

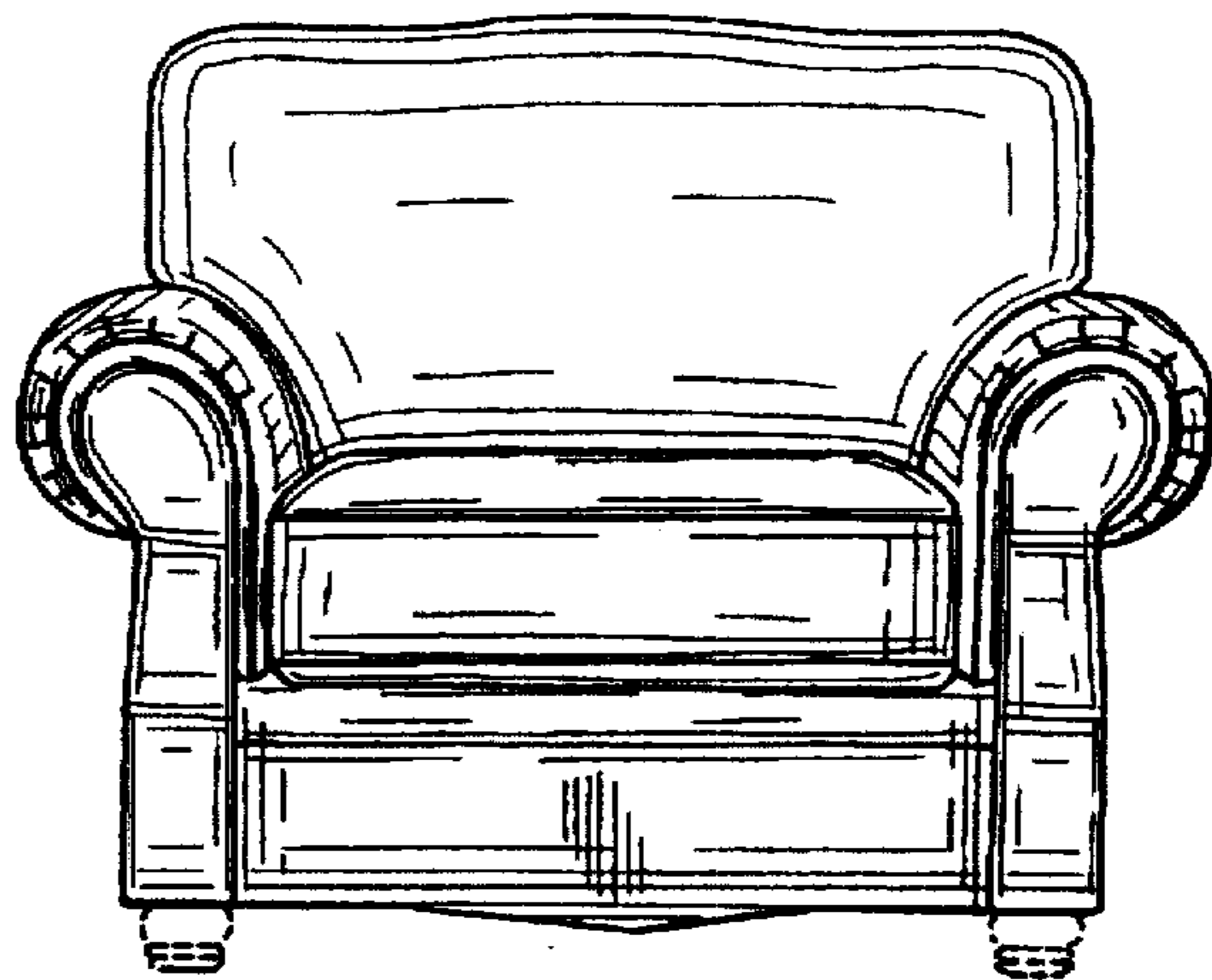

FIG. 7.