



US00D392784S

United States Patent [19]
Hellinger et al.

[11] **Patent Number:** **Des. 392,784**
[45] **Date of Patent:** ****Mar. 24, 1998**

[54] **ICE SCRAPER**

[75] **Inventors:** **Gary L. Hellinger**, Greenwich, Conn.;
Edward Wagschal, New York, N.Y.

[73] **Assignee:** **Gary Plastic Packaging Corp.**, Bronx,
N.Y.

[**] **Term:** **14 Years**

[21] **Appl. No.:** **67,178**

[22] **Filed:** **Feb. 28, 1997**

[51] **LOC (6) Cl.** **08-05**

[52] **U.S. Cl.** **D32/49**

[58] **Field of Search** D32/42, 46, 47,
D32/48, 49; 15/111, 236.01, 105, 236.02

[56] **References Cited**

U.S. PATENT DOCUMENTS

D. 241,498	9/1976	Smith	D32/49
D. 246,414	11/1977	Hopkins et al.	D32/46
D. 271,626	11/1983	Bauer	D32/42
D. 271,628	11/1983	Bauer	D32/49

D. 279,415	6/1985	Osrow et al.	D32/49
D. 372,349	7/1996	Adair	D32/46 X

Primary Examiner—Susan J. Lucas
Assistant Examiner—Cynthia E. Ramirez
Attorney, Agent, or Firm—Fish & Neave; Jeffrey H. Ingerman

[57] **CLAIM**

The ornamental design for an ice scraper, as shown and described.

DESCRIPTION

FIG. 1 is a top, front, right perspective view of an ice scraper showing our new design;
FIG. 2 is a top plan view thereof;
FIG. 3 is a front elevational view thereof;
FIG. 4 is a left side elevational view thereof, the right side being a mirror image;
FIG. 5 is a rear elevational view thereof;
FIG. 6 is a bottom plan view thereof; and,
FIG. 7 is a cross-sectional view thereof, taken from line 7—7 of FIG. 1.

1 Claim, 3 Drawing Sheets

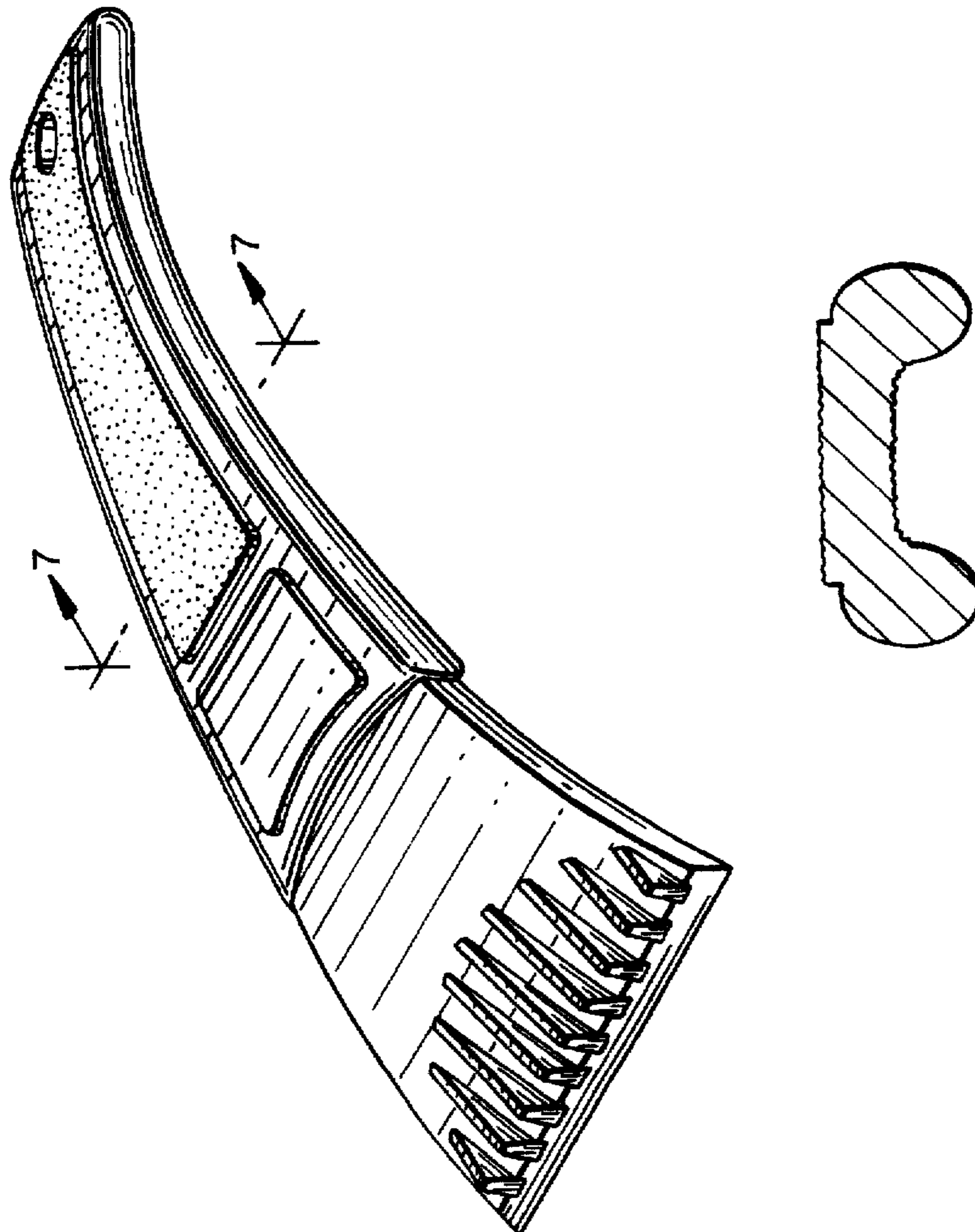

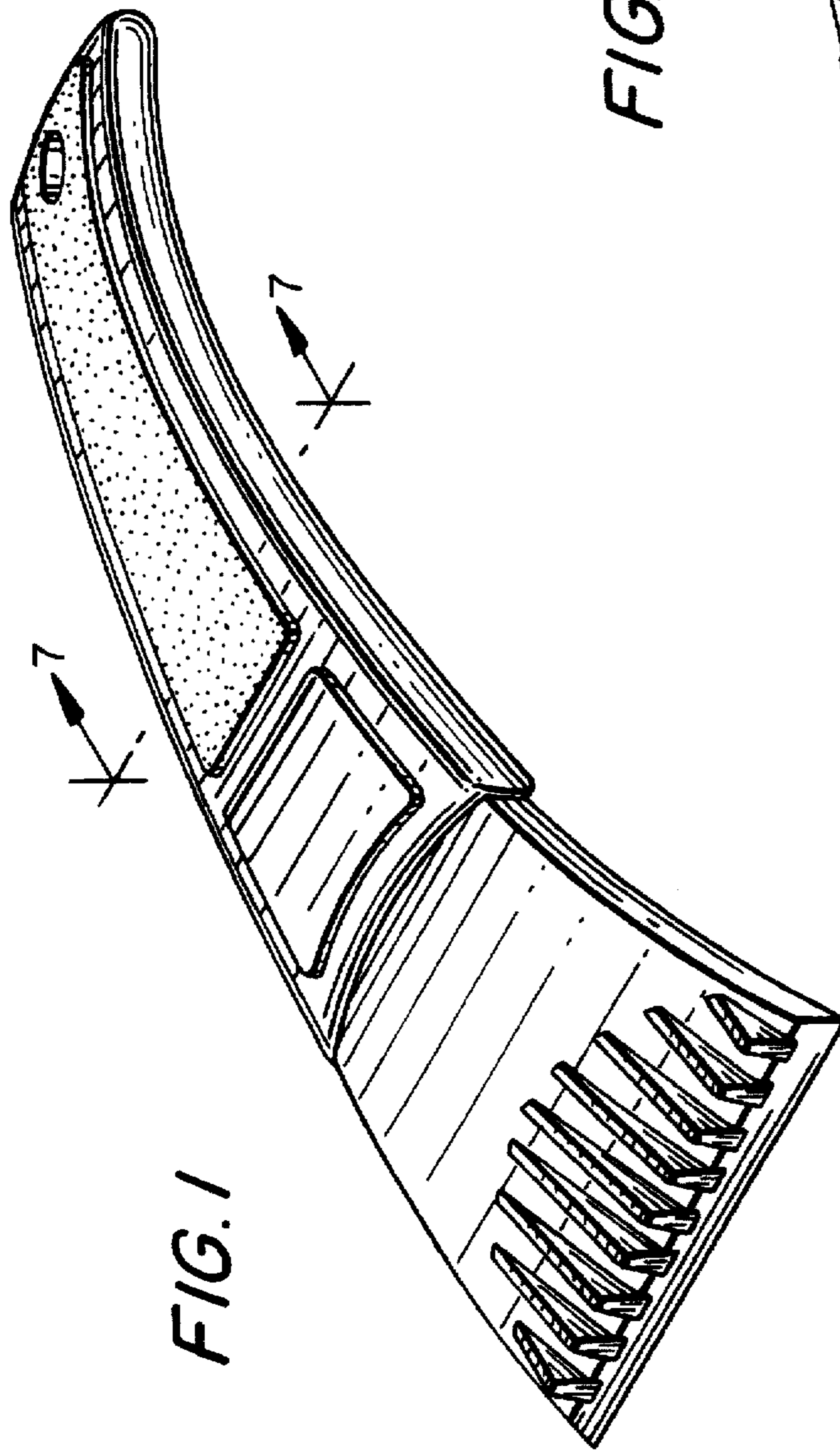

FIG. 2

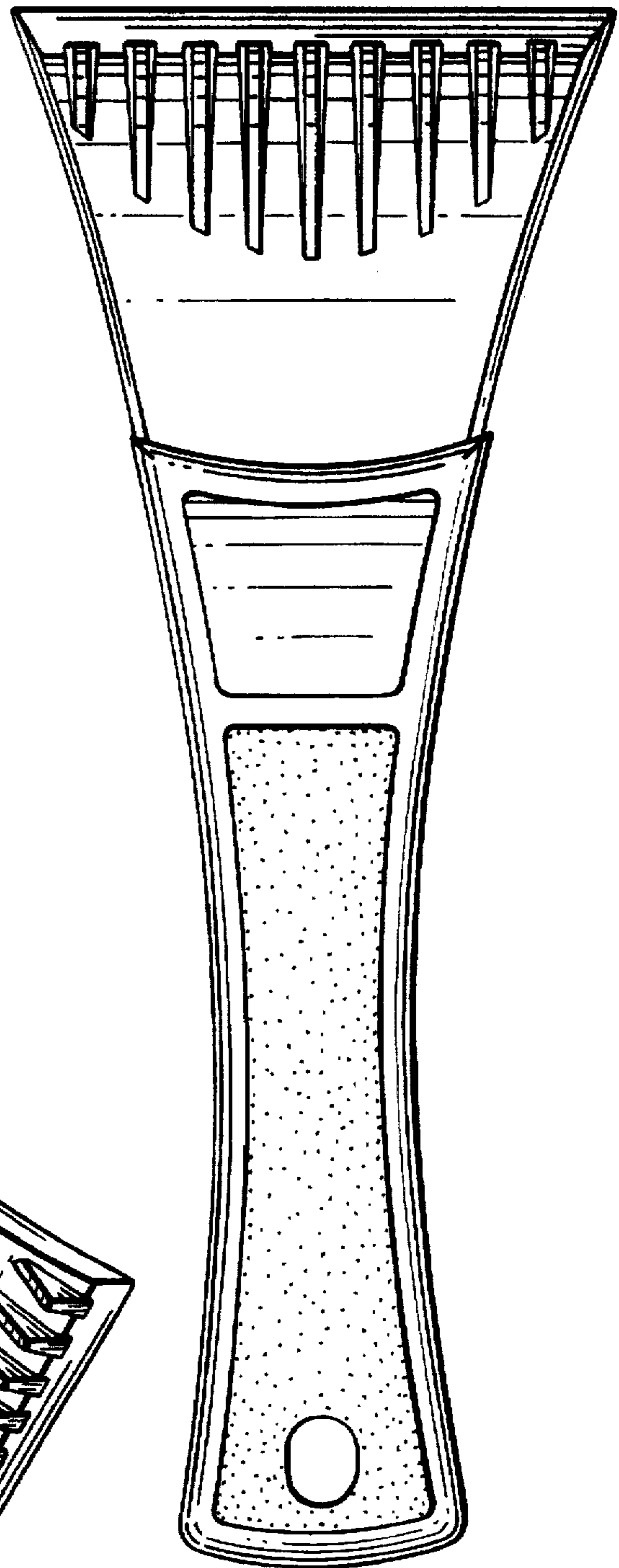

FIG. 3

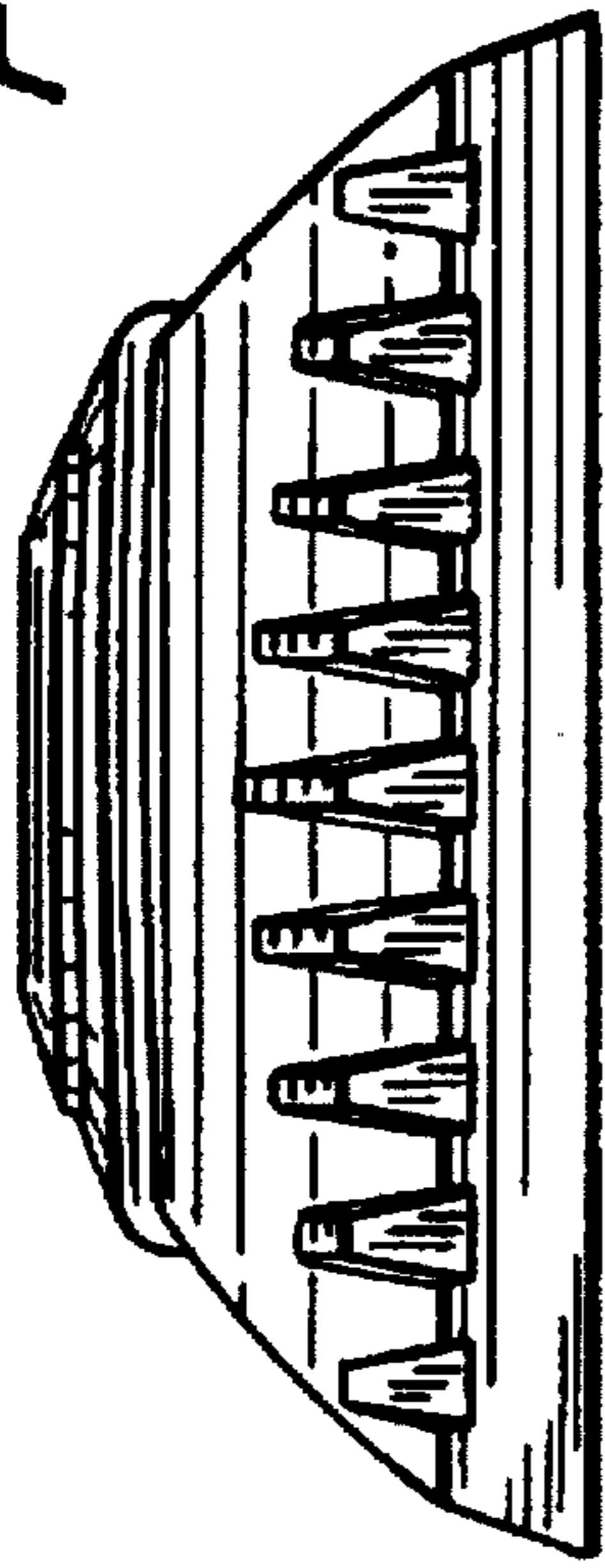

FIG. 4

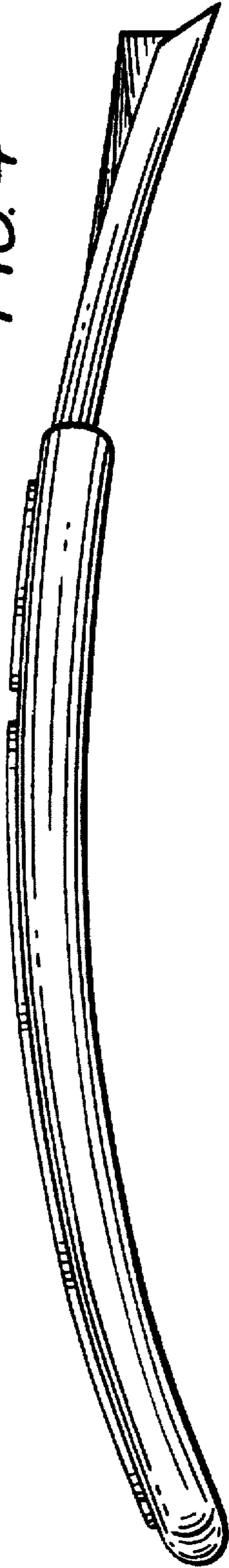
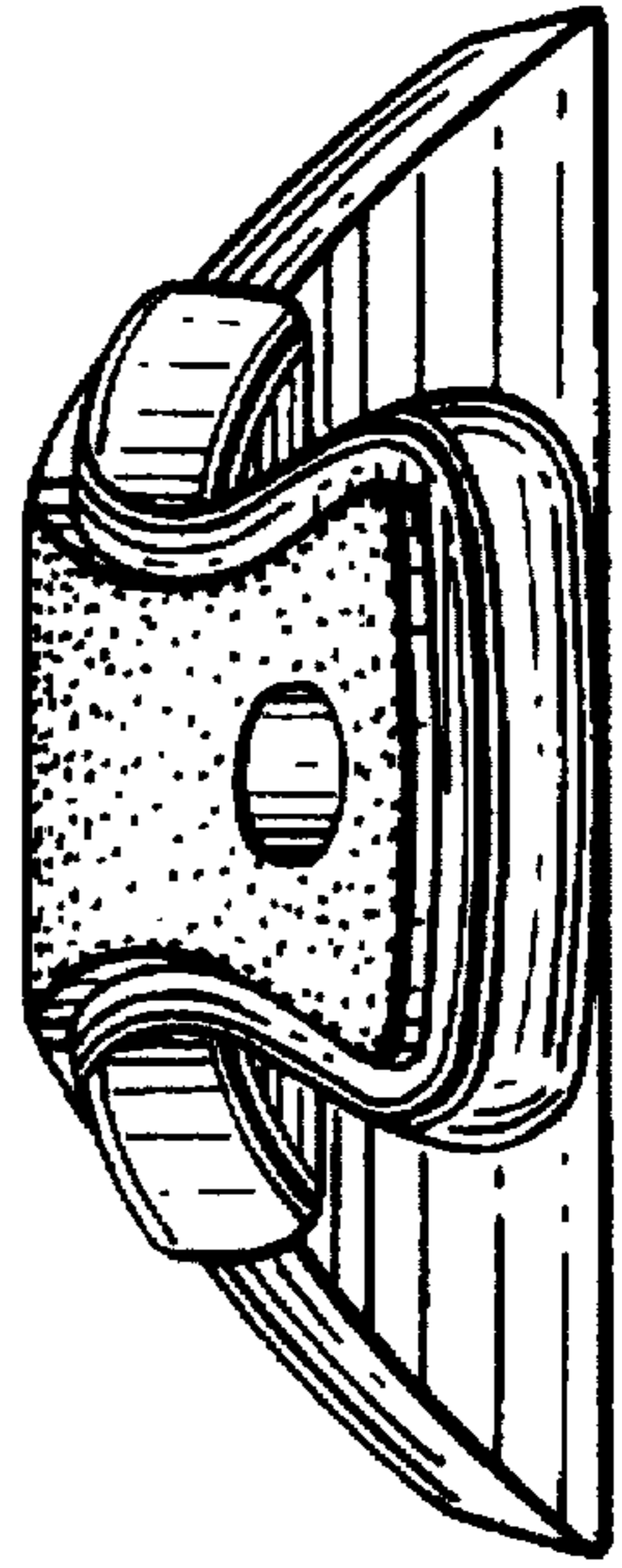

FIG. 5



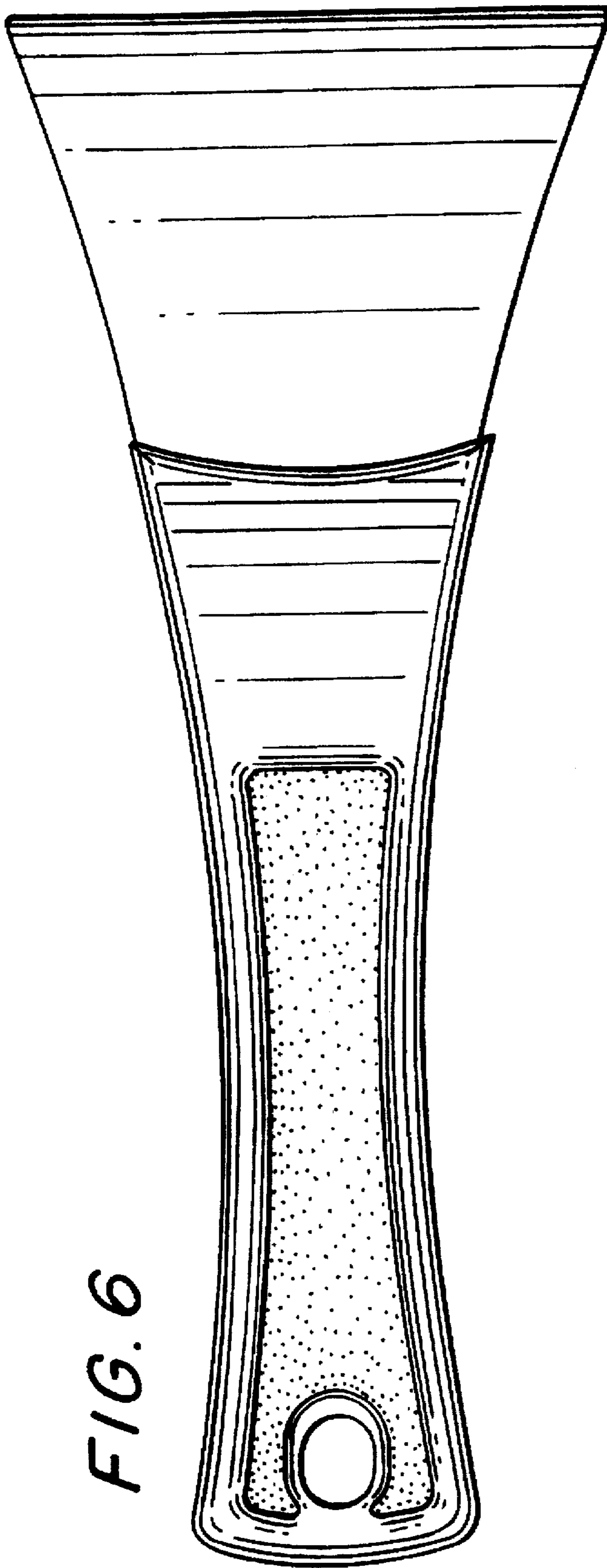

FIG. 6

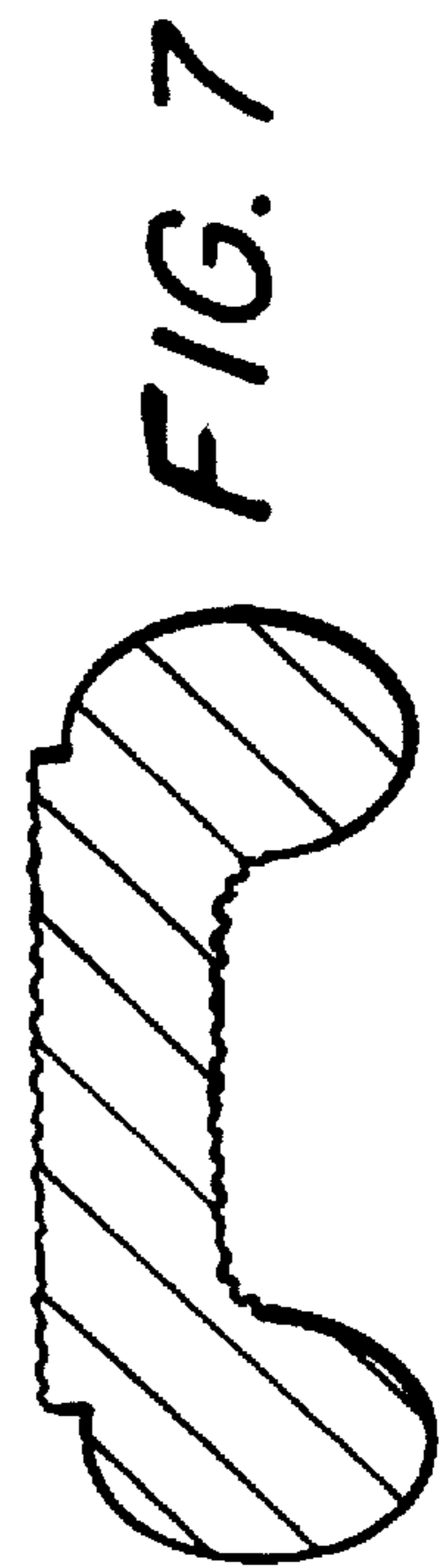

FIG. 7