



US00D392724S

United States Patent [19]
Lenardon

[11] **Patent Number: Des. 392,724**
[45] **Date of Patent: **Mar. 24, 1998**

[54] **SHOWER BASE-PLATE**

[75] **Inventor: Lucio Lenardon, Pordenone, Italy**

[73] **Assignee: Domino S.p.A., Pordenone, Italy**

[**] **Term: 14 Years**

[21] **Appl. No.: 55,326**

[22] **Filed: Jun. 5, 1996**

[30] **Foreign Application Priority Data**

Dec. 5, 1995 [IT] Italy PN950000023

[51] **LOC (6) Cl. 23-02**

[52] **U.S. Cl. D23/283**

[58] **Field of Search D23/277-280.4;
4/538, 539, 546, 548, 551, 589, 584, 590**

[56] **References Cited**

PUBLICATIONS

International Design Registration No. DM/032 601 of Ucosan B.V., The Netherlands, publication date May 31, 1995.

Primary Examiner—Louis S. Zarfaz

Assistant Examiner—Eric Watterson

Attorney, Agent, or Firm—Wenderoth, Lind & Ponac

[57] **CLAIM**

The ornamental design for a shower base-plate, as shown and described.

DESCRIPTION

FIG. 1 is a top plan view of a first embodiment of a shower base-plate according to my new design;

FIG. 2 is a front elevational view thereof, the right side elevational view being a mirror image thereof;

FIG. 3 is a rear elevational view thereof;

FIG. 4 is a left side elevational view thereof;

FIG. 5 is a top plan view of a second embodiment of a shower base-plate according to my new design;

FIG. 6 is a front elevational view thereof, the left side elevational view being a mirror image thereof;

FIG. 7 is a rear elevational view thereof;

FIG. 8 is a right side elevational view thereof;

FIG. 9 is a top plan view showing the first embodiment of a shower base-plate according to my new design in combination with a bathtub;

FIG. 10 is a top plan view showing the second embodiment of a shower base-plate according to my new design in combination with a bathtub;

FIG. 11 is another combination of the shower base-plate and bathtub shown in FIG. 9;

FIG. 12 is another combination of the shower base-plate and bathtub shown in FIG. 10;

FIG. 13 is another combination of the shower base-plate and bathtub shown in FIG. 10;

FIG. 14 is another combination of the shower base-plate and bathtub shown in FIG. 10;

FIG. 15 is another combination of the bathtub and shower base-plate shown in FIG. 9; and,

FIG. 16 is another combination of the shower base-plate and bathtub shown in FIG. 9.

1 Claim, 4 Drawing Sheets

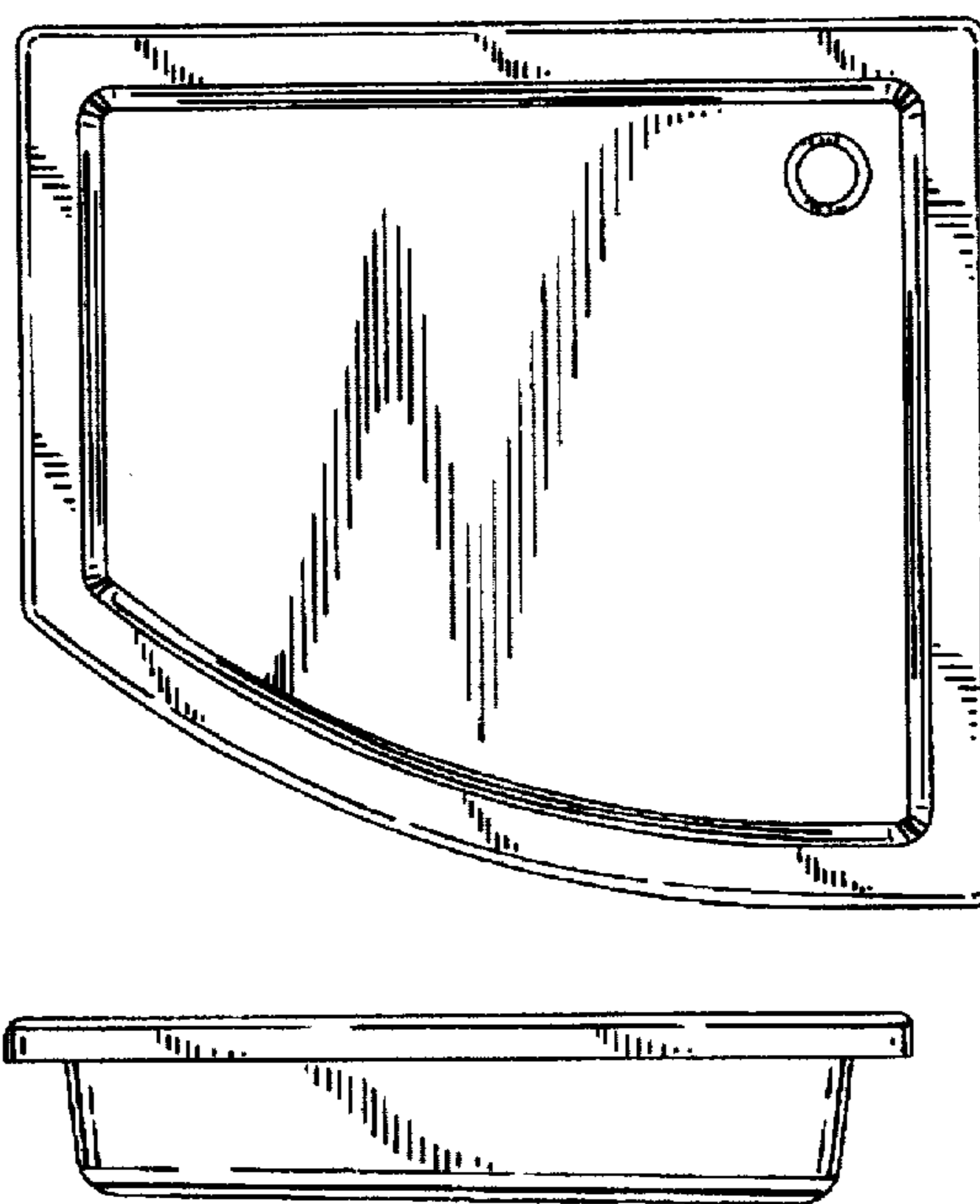

Fig. 1

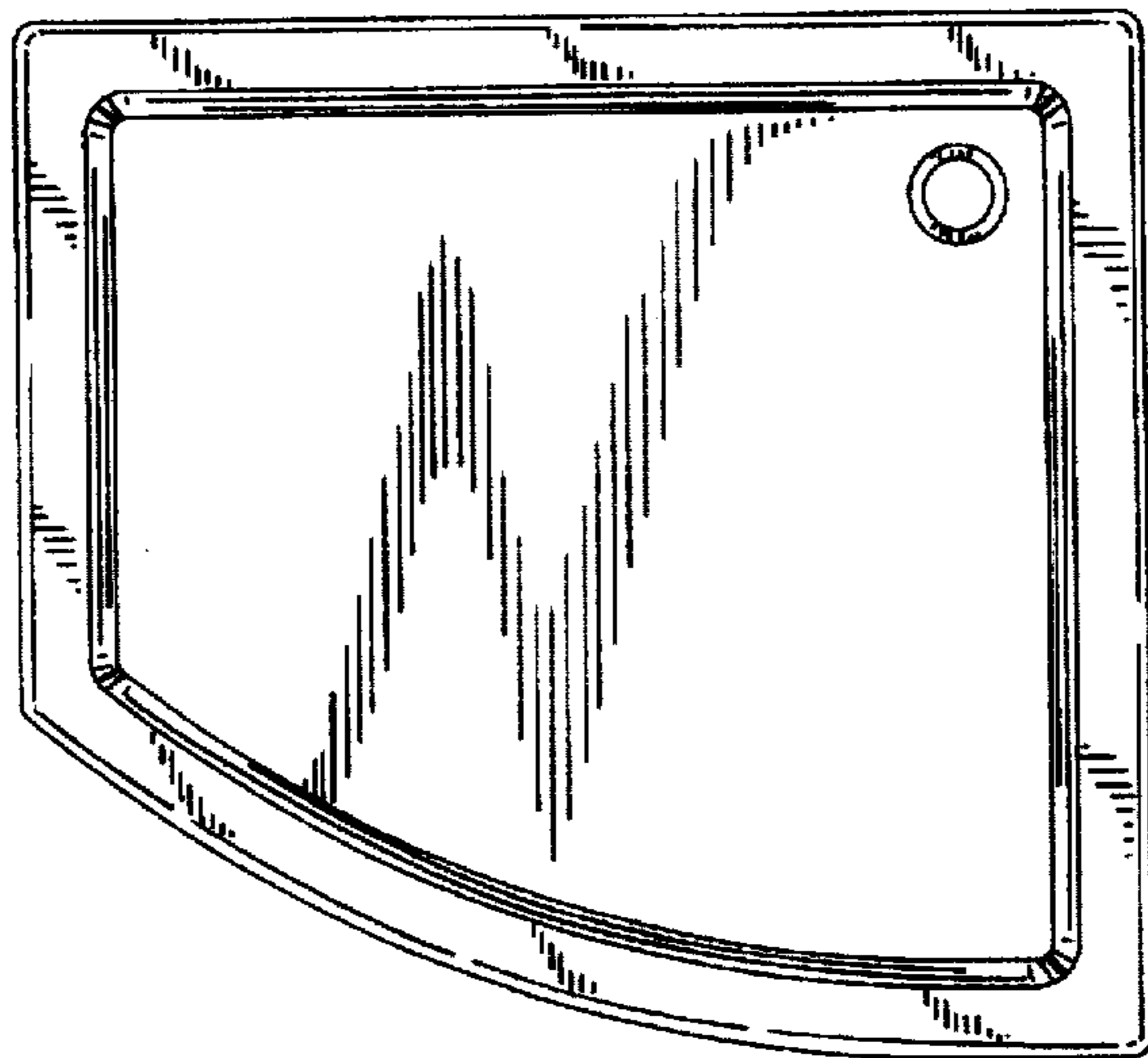

Fig. 2



Fig. 3

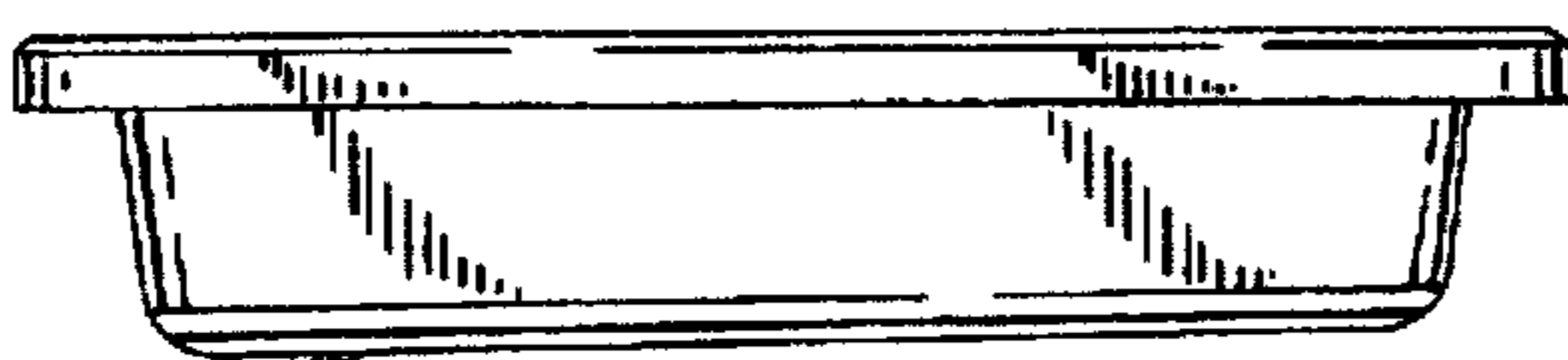
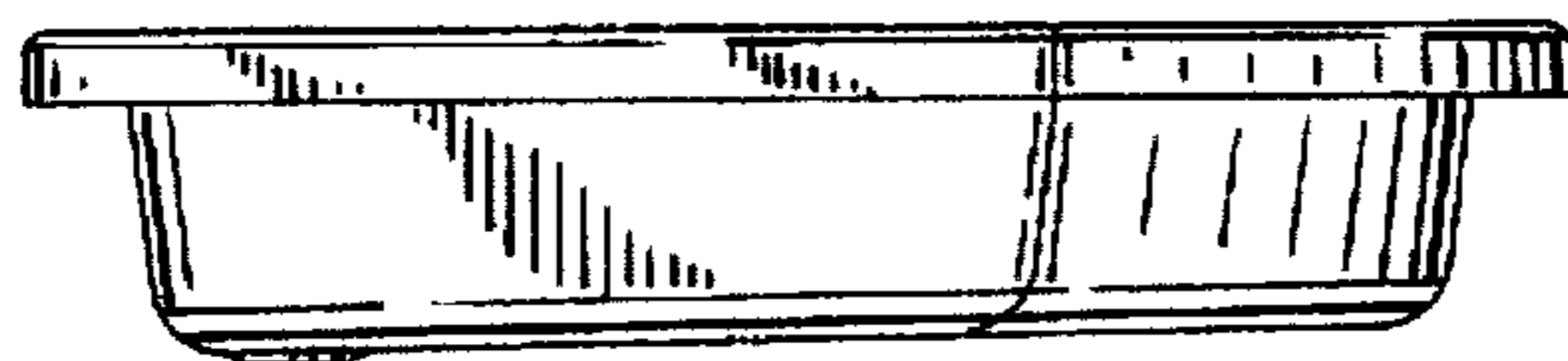

Fig. 4



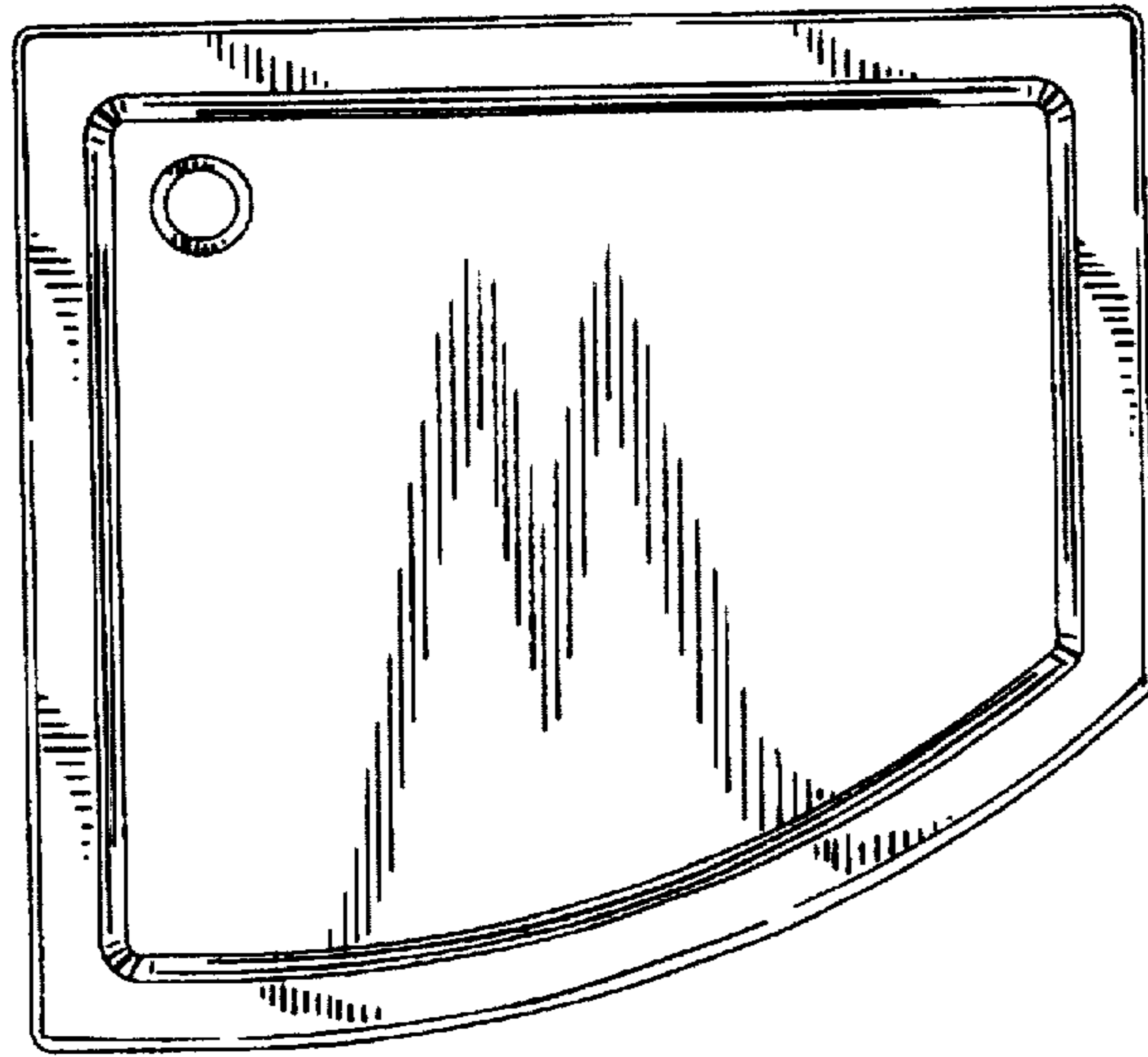

Fig. 5

Fig. 6

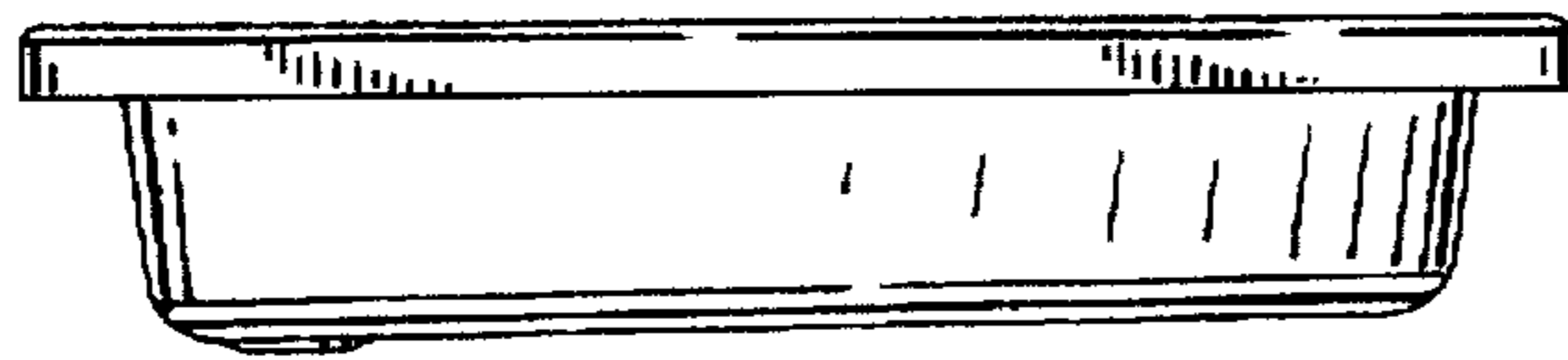

Fig. 7

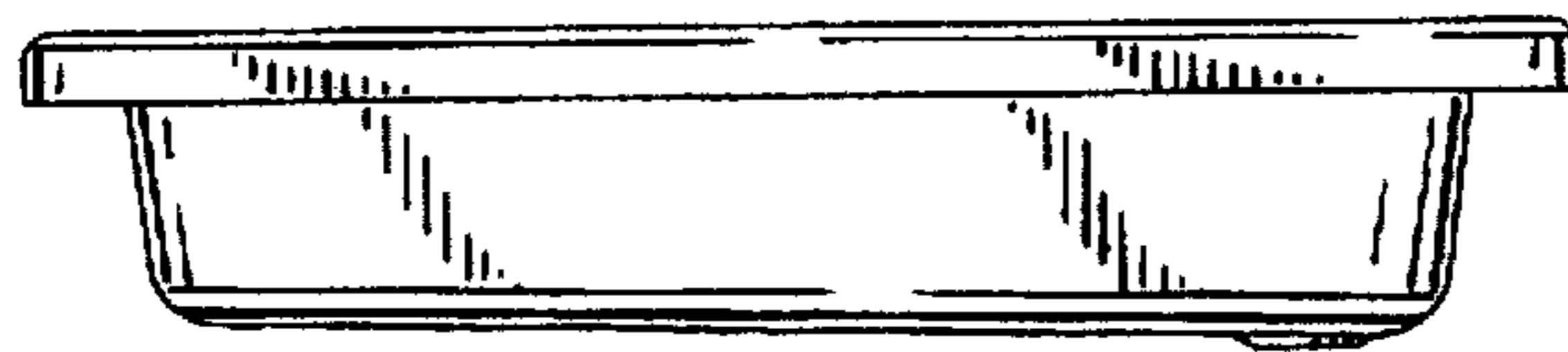
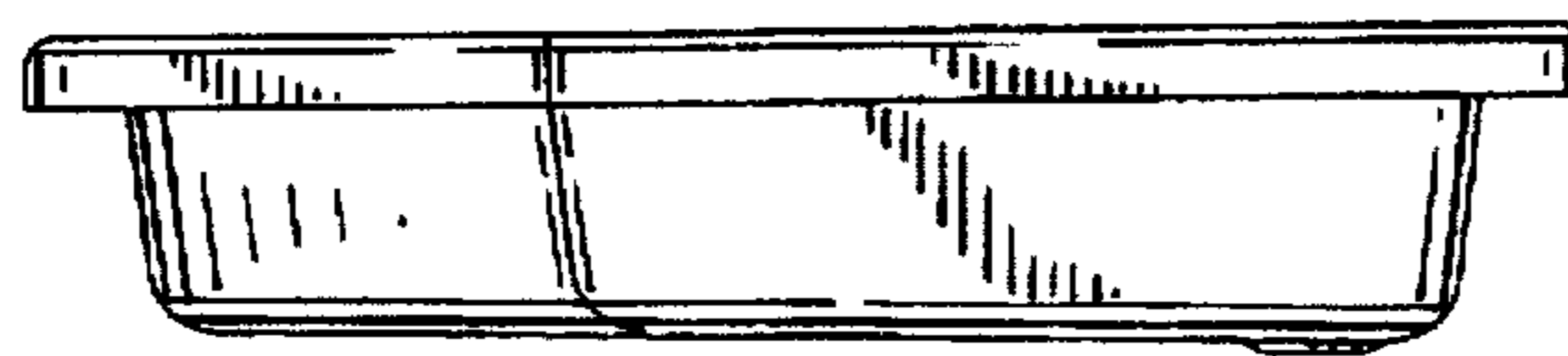

Fig. 8



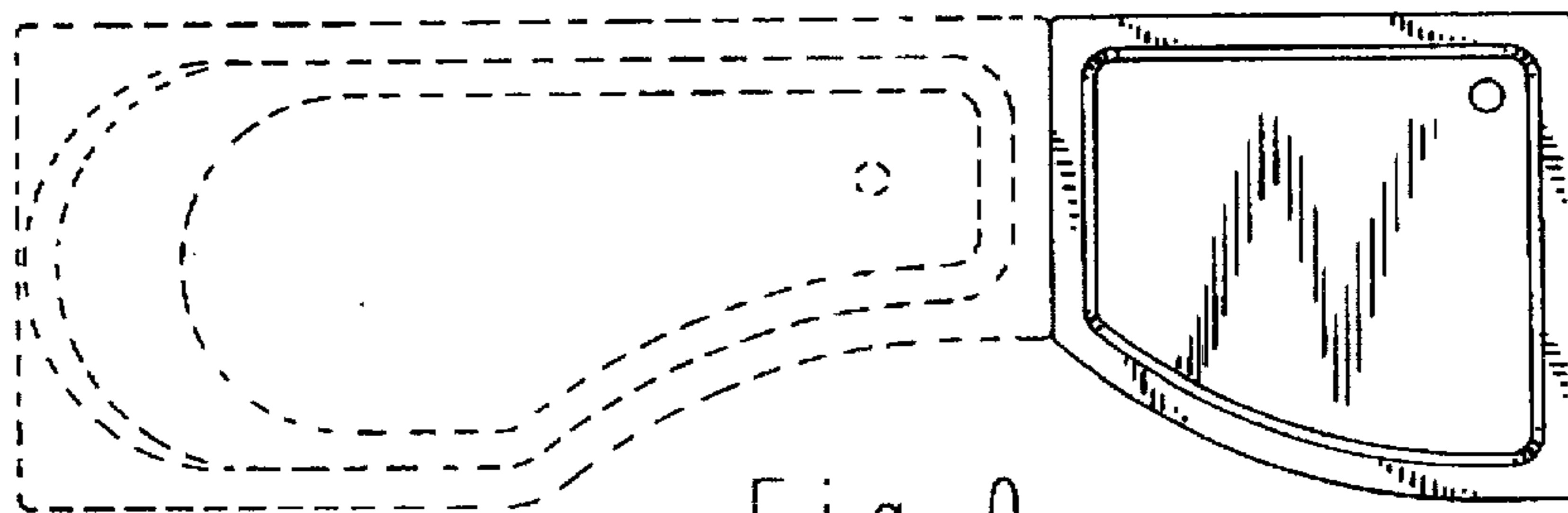

Fig. 9

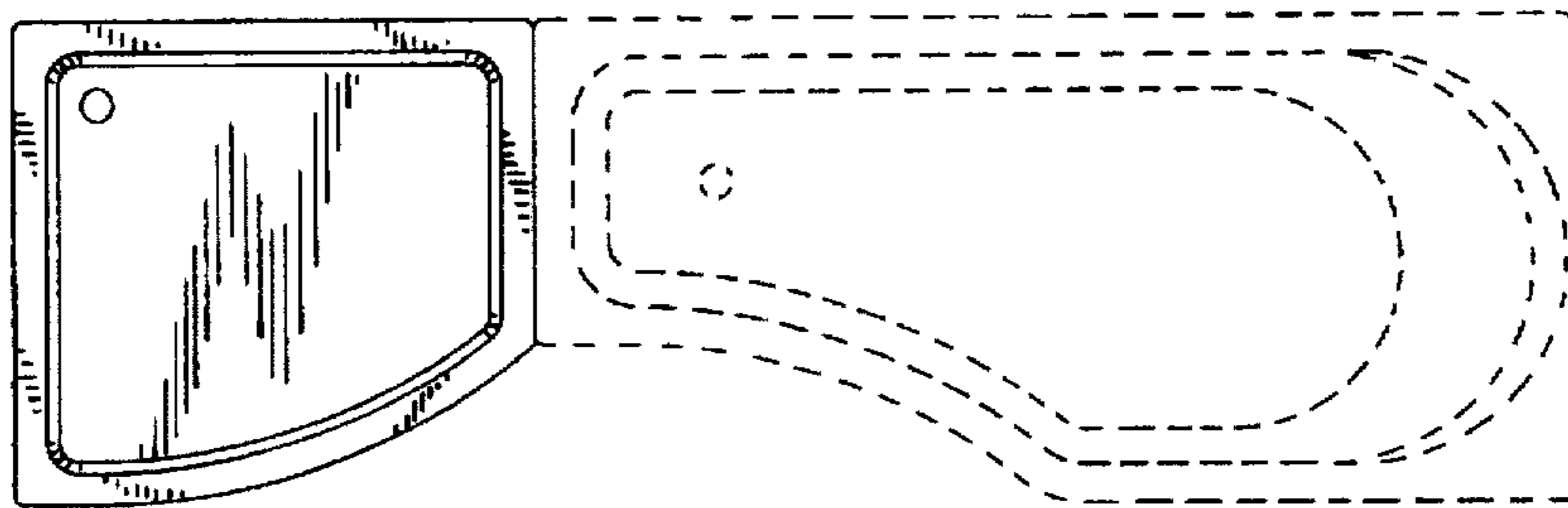

Fig. 10

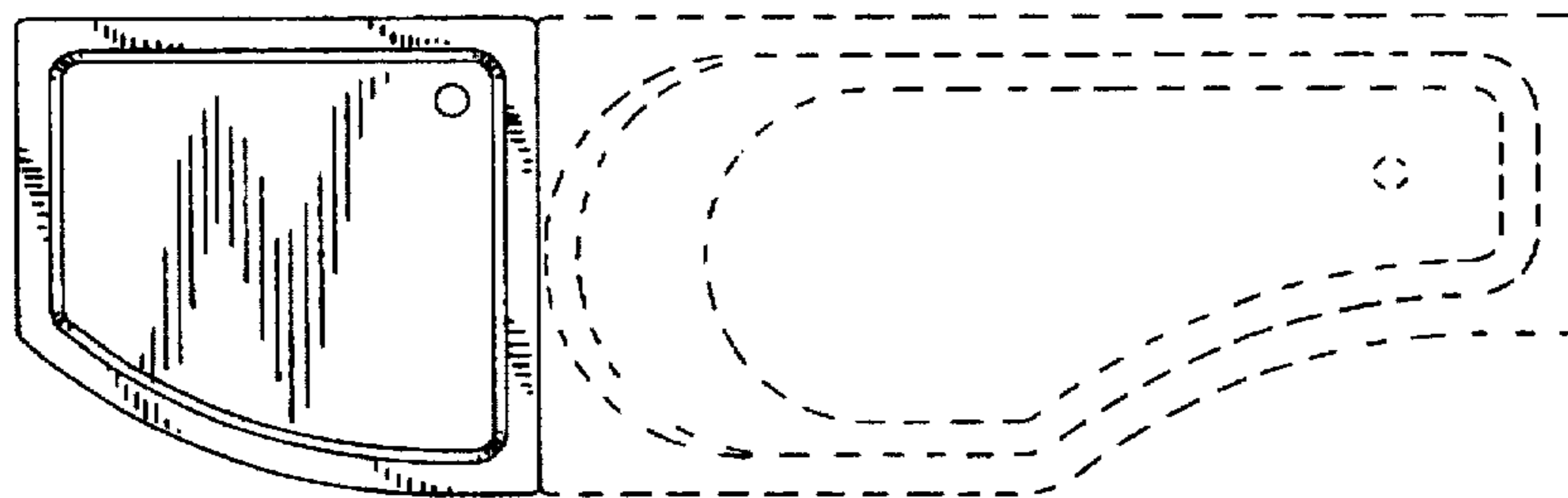

Fig. 11

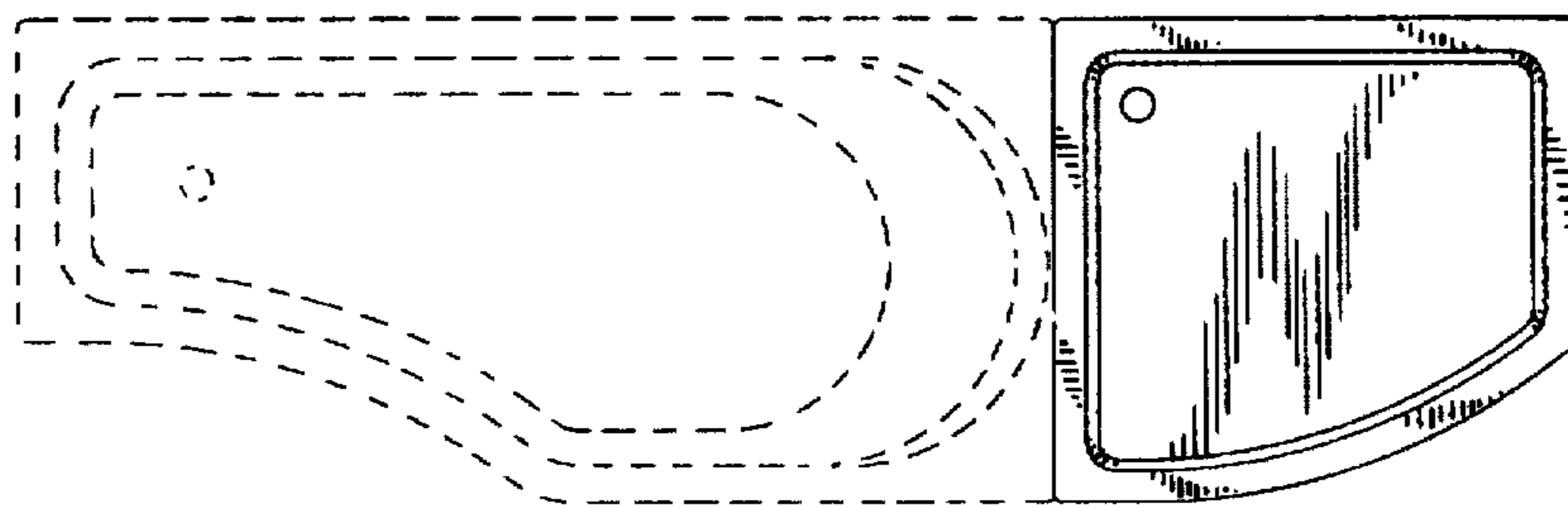

Fig. 12

