

US00D392640S

United States Patent [19]

Tully et al.

[11] Patent Number: **Des. 392,640**

[45] Date of Patent: ****Mar. 24, 1998**

[54] AMPLIFIED SUBWOOFER TUBE SPEAKER

[75] Inventors: **Peter A. Tully; Jeff B. Jordan**, both of Baton Rouge, La.

[73] Assignee: **Southern Audio Services, Inc.**, Baton Rouge, La.

[**] Term: **14 Years**

[21] Appl. No.: **62,488**

[22] Filed: **Nov. 15, 1996**

[51] LOC (6) Cl. **14-01**

[52] U.S. Cl. **D14/216; D14/215; D14/188**

[58] Field of Search **D14/204, 207, D14/209-216; 181/144-145, 147-148, 153, 157, 198, 199; 381/24, 88, 90-91, 153, 159, 186, 188, 203, 205**

[56] References Cited

U.S. PATENT DOCUMENTS

D. 338,672	8/1993	Watanabe et al.	D14/216
D. 385,746	11/1997	Wu	D14/215 X
4,756,382	7/1988	Hudson, III	181/153 X
5,191,177	3/1993	Chi	181/153

OTHER PUBLICATIONS

Bazooka Bass Tubes catalog, p. 3, speaker systems, Oct. 1993.

Primary Examiner—Ted Shooman

Assistant Examiner—Nanda Bondade

Attorney, Agent, or Firm—Roy, Kiesel & Tucker

[57] CLAIM

The ornamental design for the amplified subwoofer tube speaker, as shown.

DESCRIPTION

FIG. 1 is a three-quarter perspective view showing the front, side and top of the amplified subwoofer tube speaker;

FIG. 2 is an front view of the amplified subwoofer tube speaker;

FIG. 3 is a top view of the amplified subwoofer tube speaker;

FIG. 4 is a rear view of the amplified subwoofer tube speaker;

FIG. 5 is a bottom view of the amplified subwoofer tube speaker;

FIG. 6 is a right side view of the amplified subwoofer tube speaker when viewed from the front; and,

FIG. 7 is a left side view of the amplified subwoofer tube speaker when viewed from the front.

1 Claim, 4 Drawing Sheets

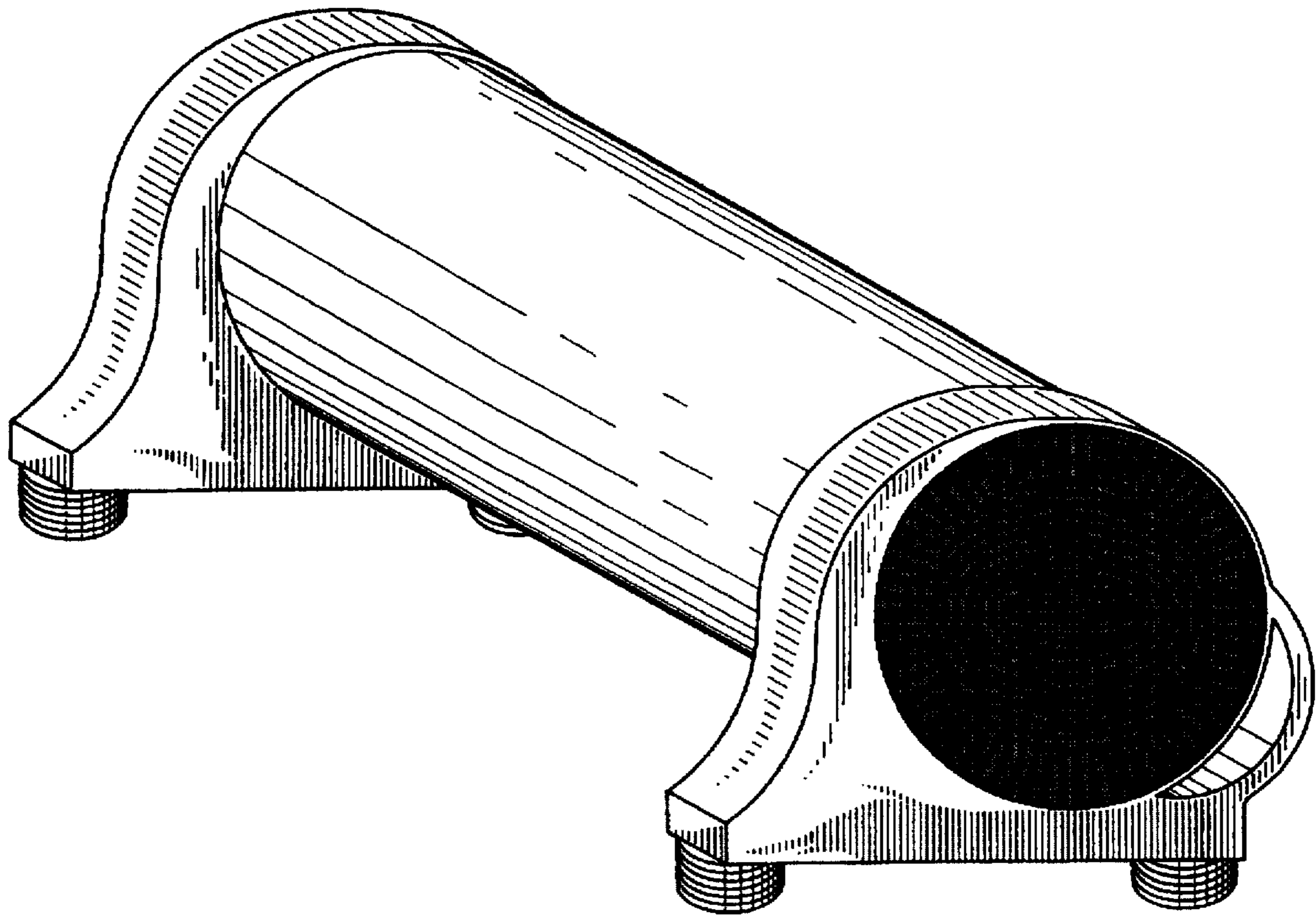

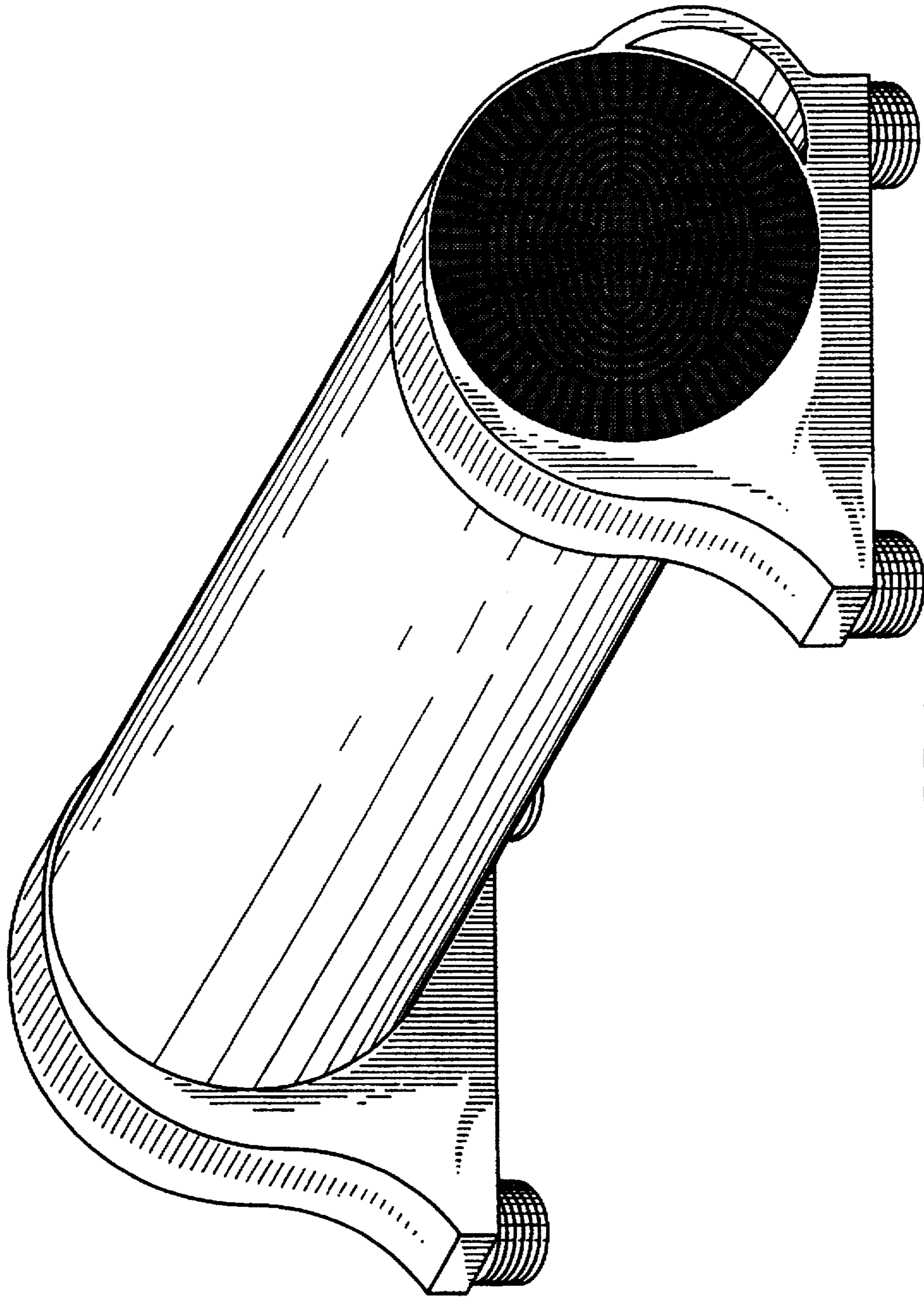

FIGURE 1

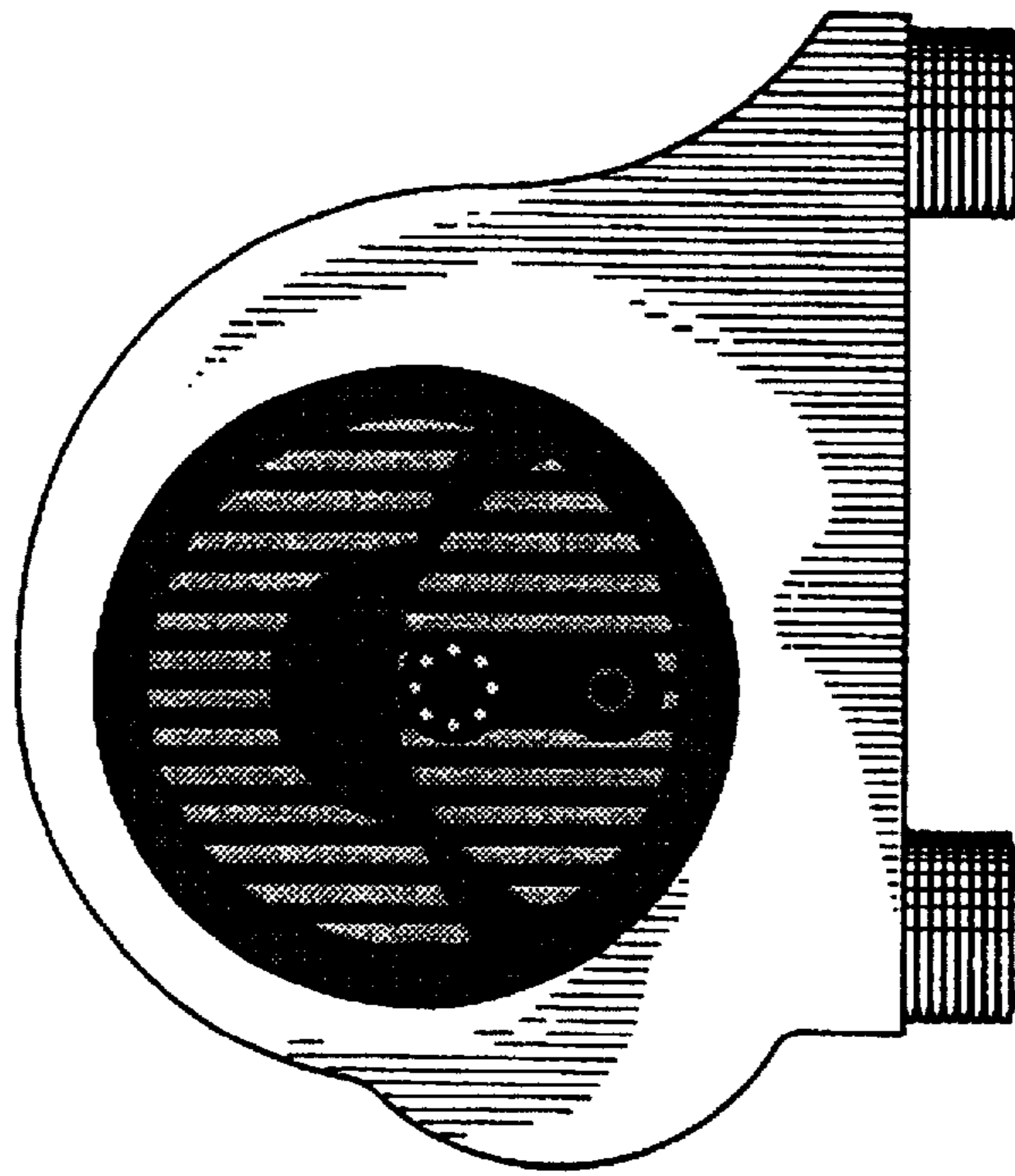

FIGURE 4

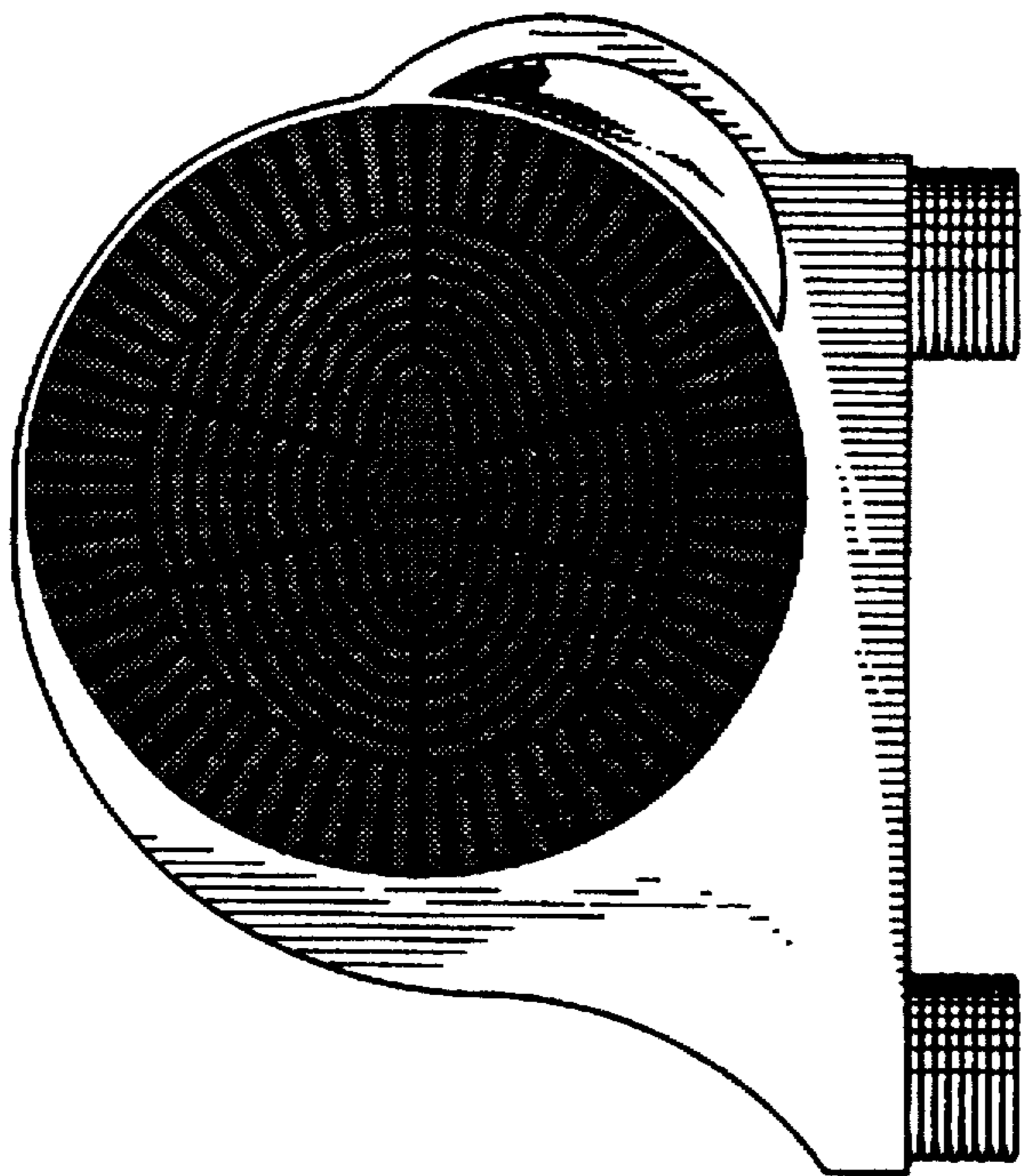

FIGURE 2

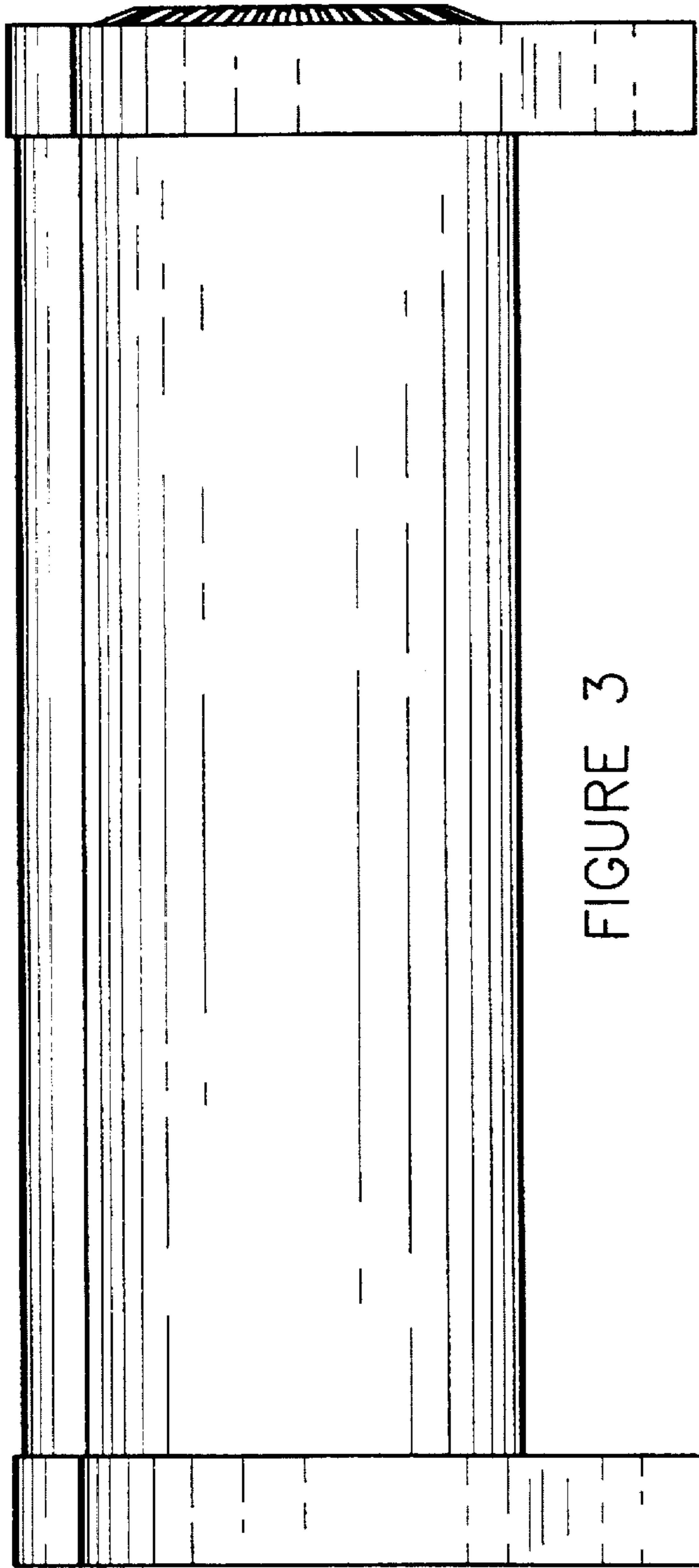

FIGURE 3

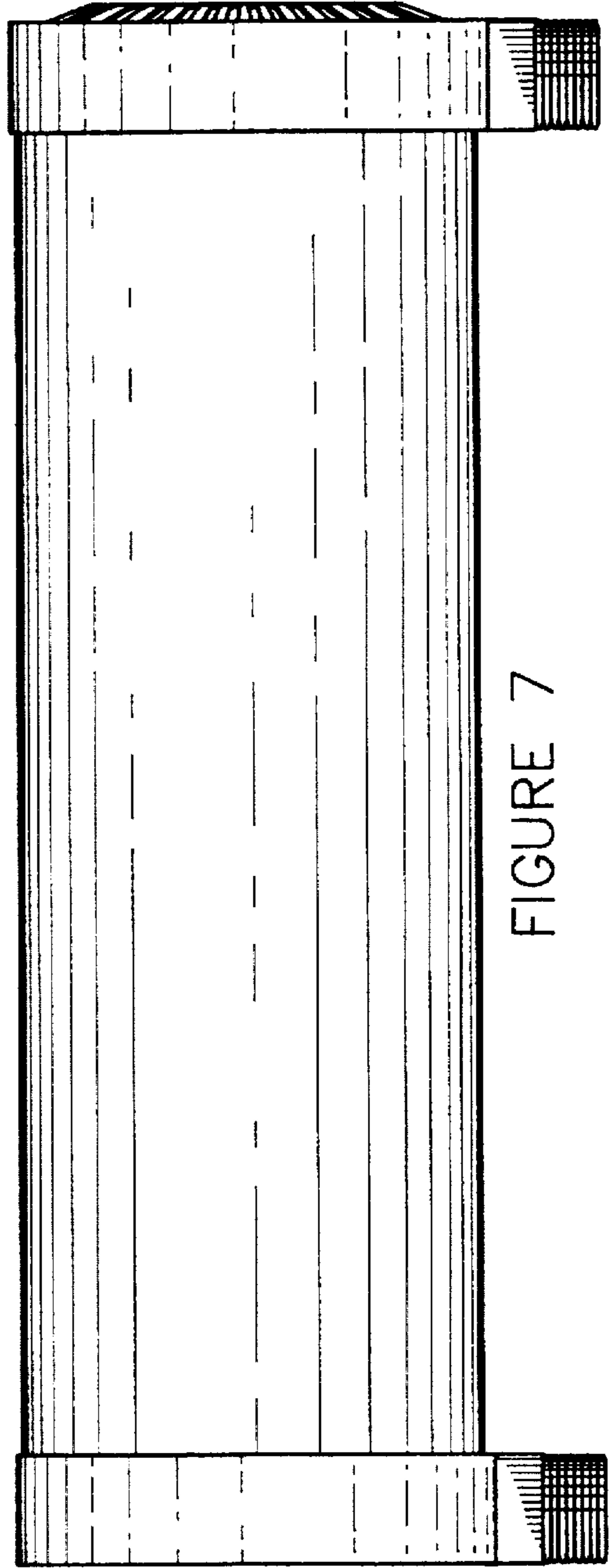

FIGURE 7

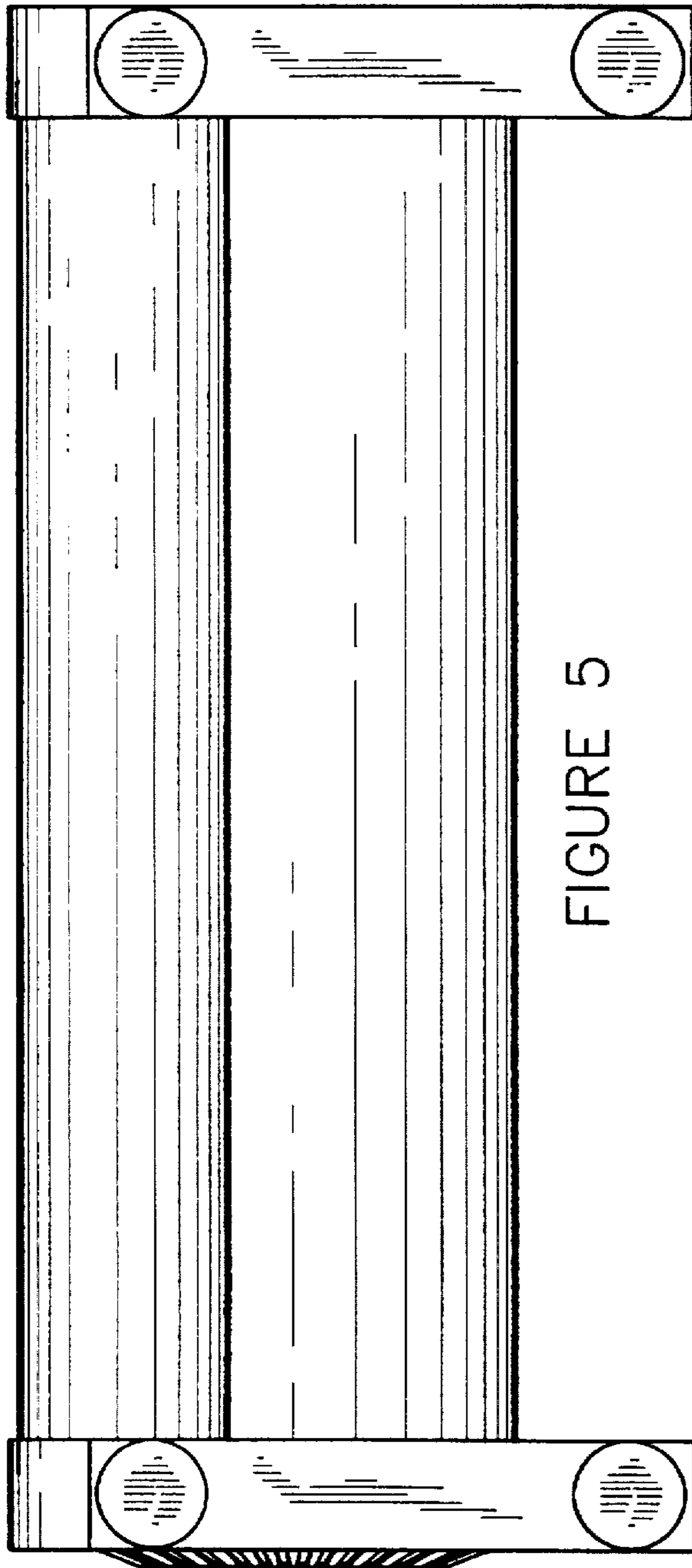

FIGURE 5

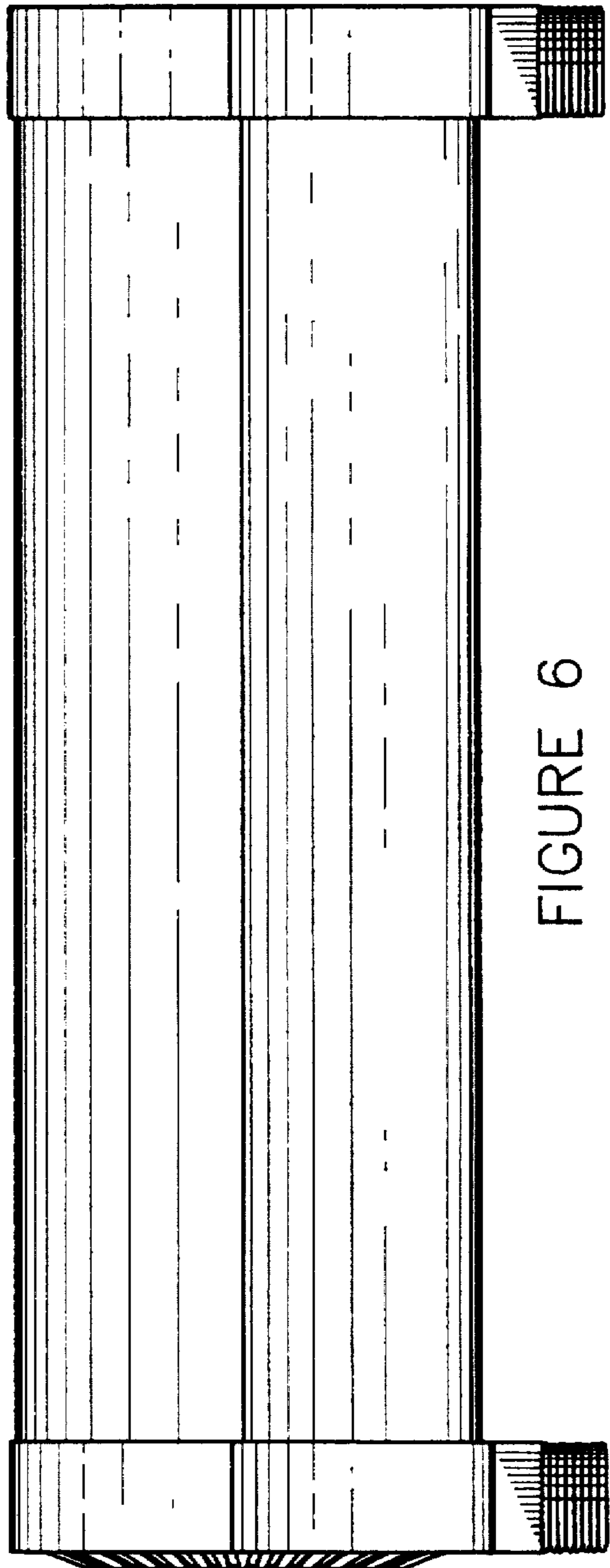

FIGURE 6