



US00D392538S

United States Patent [19]

Buck et al.

[11] Patent Number: **Des. 392,538**

[45] Date of Patent: ****Mar. 24, 1998**

[54] FOLDING BLADE KNIFE

[75] Inventors: **Charles T. Buck**, El Cajon; **Charles B. Buck**, Lakeside; **William Keys**; **Tom Gaboury**, both of El Cajon, all of Calif.

[73] Assignee: **Buck Knives, Inc.**, El Cajon, Calif.

[**] Term: **14 Years**

[21] Appl. No.: **46,961**

[22] Filed: **Nov. 22, 1995**

Related U.S. Application Data

[63] Continuation of Ser. No. 33,356, Jan. 11, 1995, abandoned.

[51] LOC (6) Cl. **08-03**

[52] U.S. Cl. **D8/99**

[58] Field of Search D8/99, 107; D22/118; 30/155, 156, 157, 158, 159, 160, 161

[56] References Cited

U.S. PATENT DOCUMENTS

D. 224,389	7/1972	Wood	D8/99
D. 310,621	9/1990	Thompson	D8/99
D. 348,818	7/1994	Hasegawa	D8/99
3,783,509	1/1974	Lake	D8/99
4,133,106	1/1979	Addis	30/160
4,170,061	10/1979	Henry	30/160
4,404,748	9/1983	Wiethoff	30/161
4,451,982	6/1984	Collins	D8/99

OTHER PUBLICATIONS

Special Projects Catalog, 1992, p. 30, Cold Steel Folders. "The Magnadot"; top left portion of catalog page (Undated); Publisher Unknown.

"Voyager™ Series Lockbacks" by Cold Steel; center of catalog page (Undated); Publisher Unknown.

Primary Examiner—Philip S. Hyder
Attorney, Agent, or Firm—Jones, Tullar & Cooper, P.C.

[57] CLAIM

The ornamental design for a folding blade knife, as shown.

DESCRIPTION

FIG. 1 is a front perspective view of the folding blade knife showing our new design with the folding blade closed;

FIG. 2 is a rear perspective view thereof, showing the folding blade partially unfolded;

FIG. 3 is a front perspective view thereof, showing the folding blade completely unfolded;

FIG. 4 is a right side elevational view thereof, shown with the folding blade closed, it being understood that the left side elevational view is the same;

FIG. 5 is a top plan view thereof;

FIG. 6 is a bottom plan view thereof;

FIG. 7 is a right end view thereof; and,

FIG. 8 is a left end view of the folding blade knife in accordance with our new design.

1 Claim, 2 Drawing Sheets

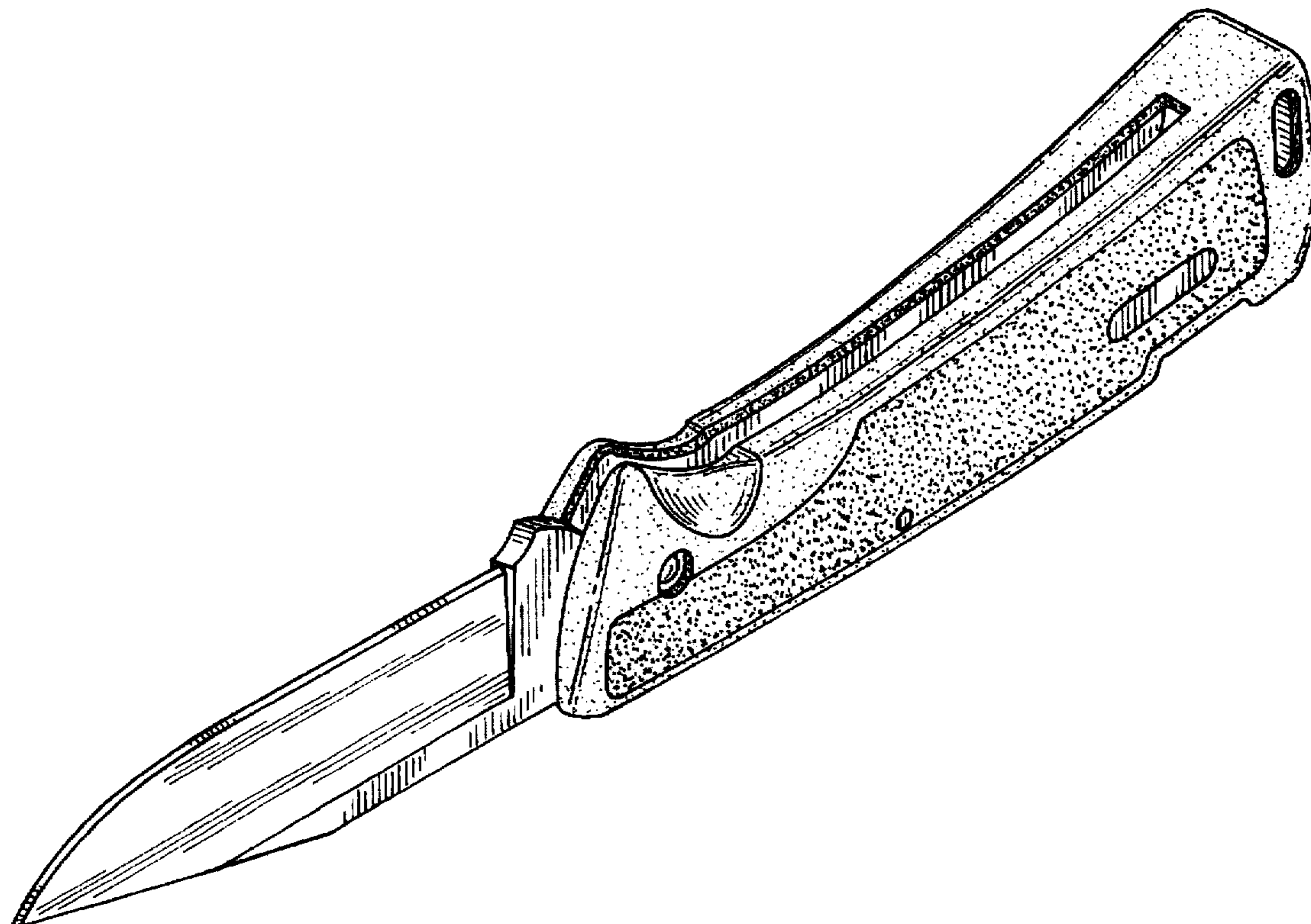

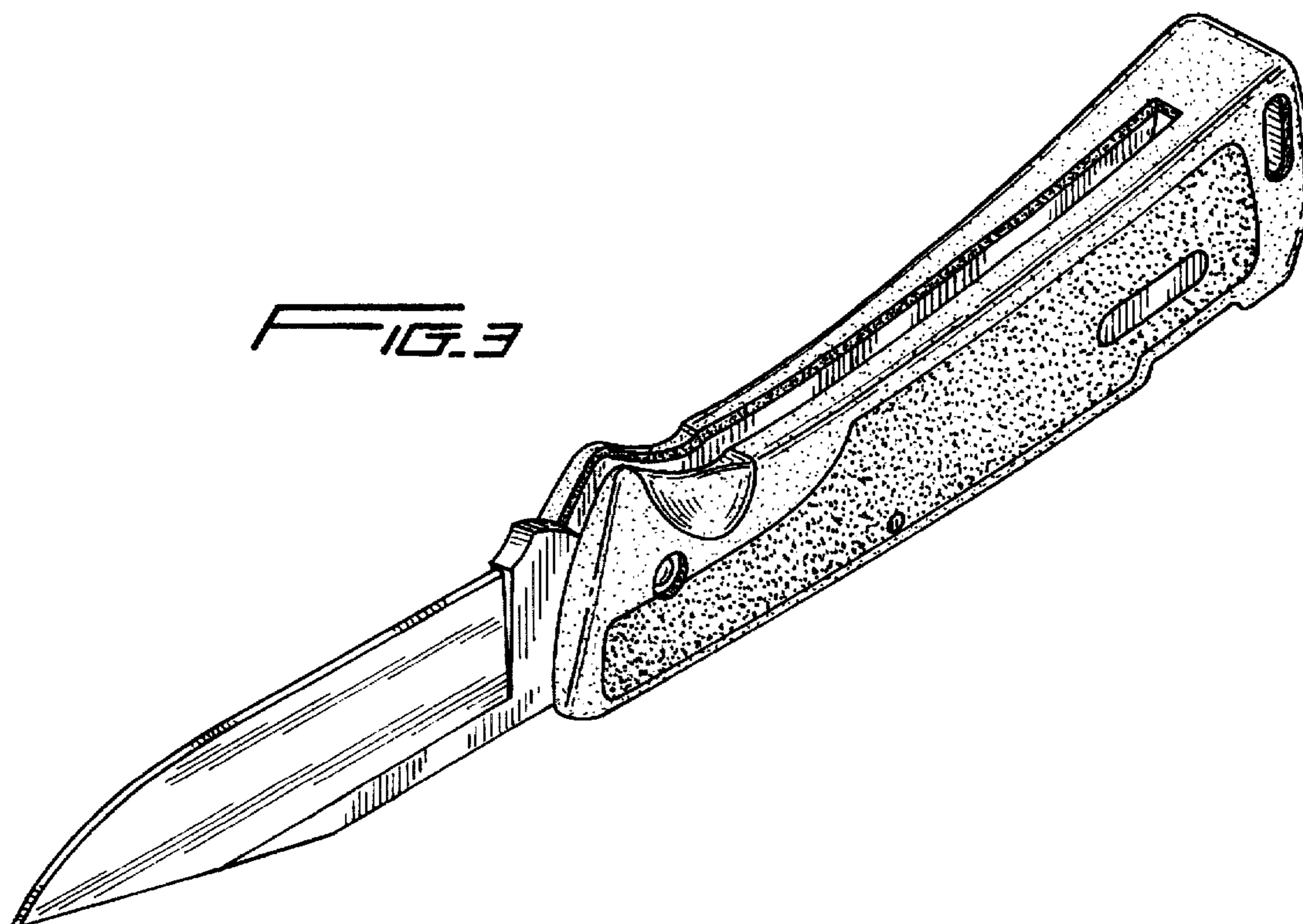
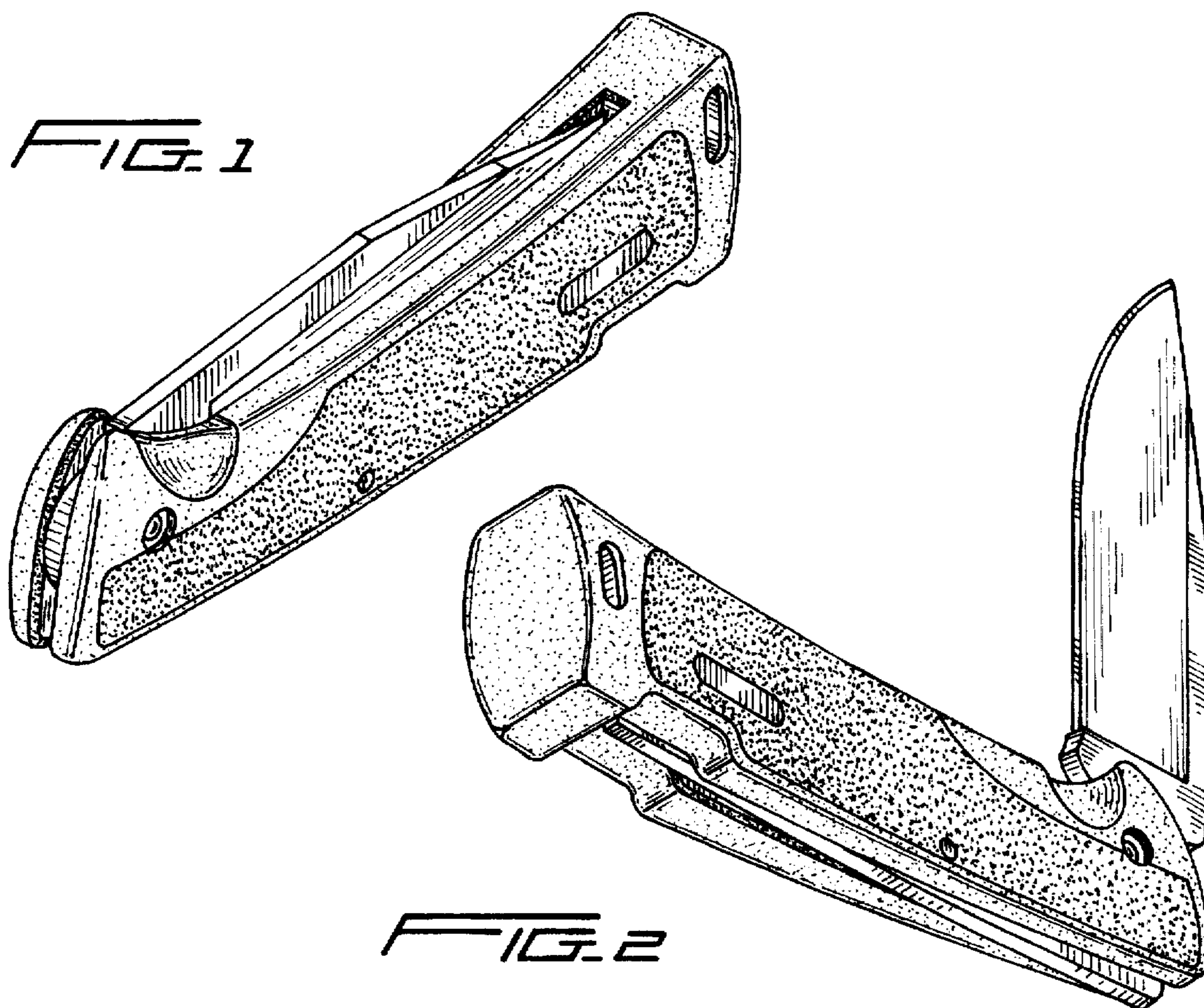

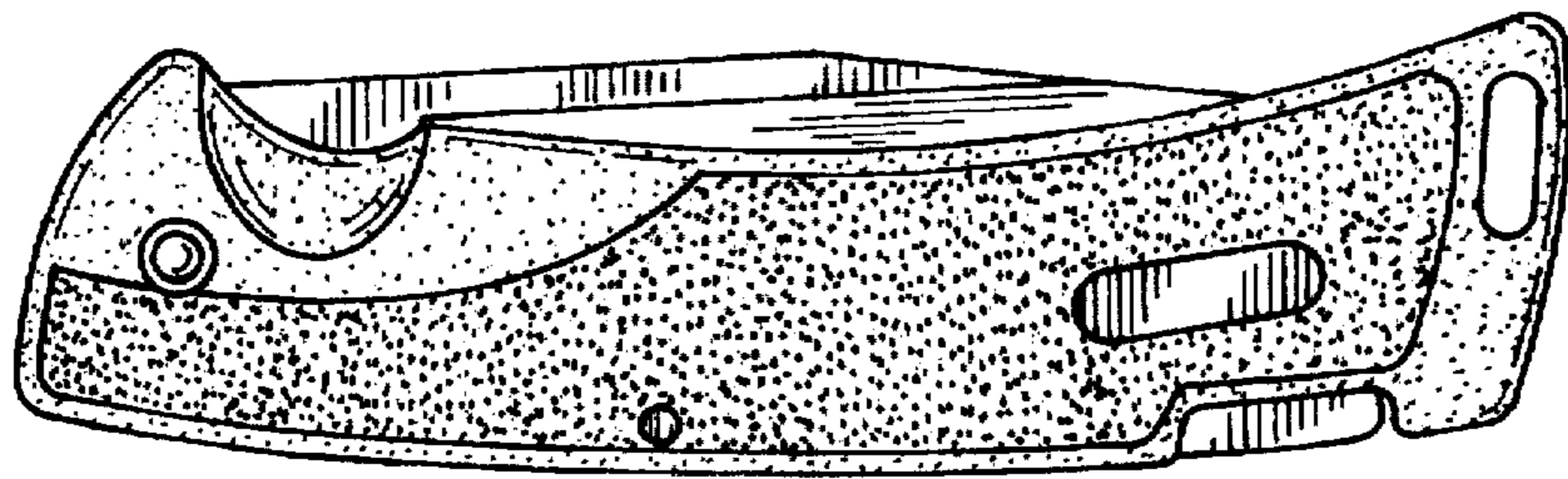

FIG. 4

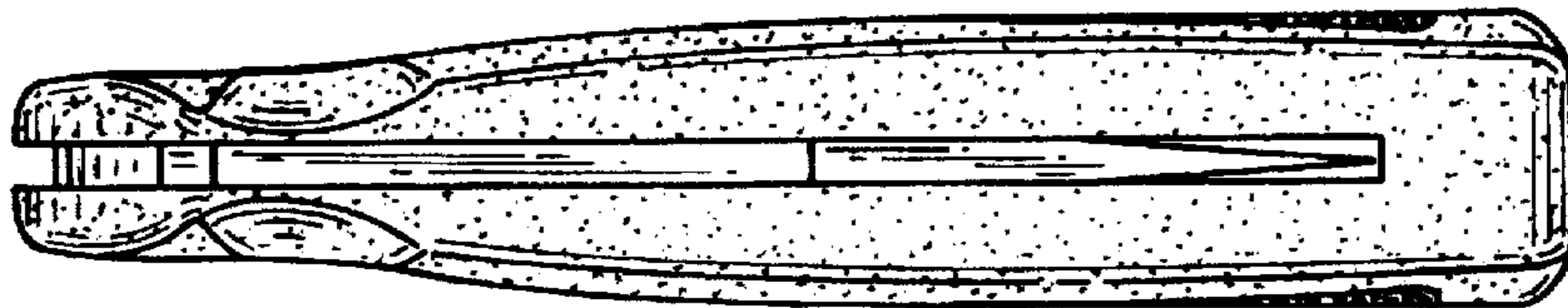

FIG. 5

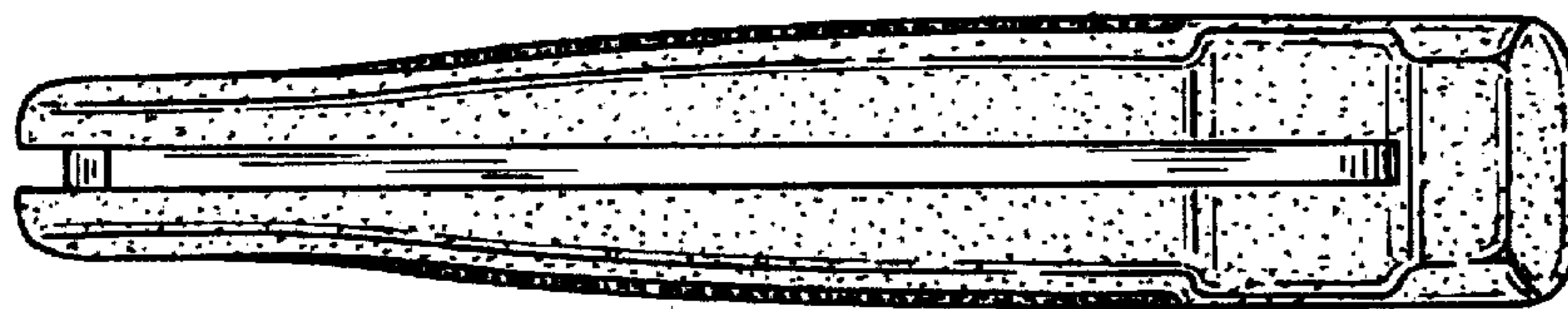

FIG. 6

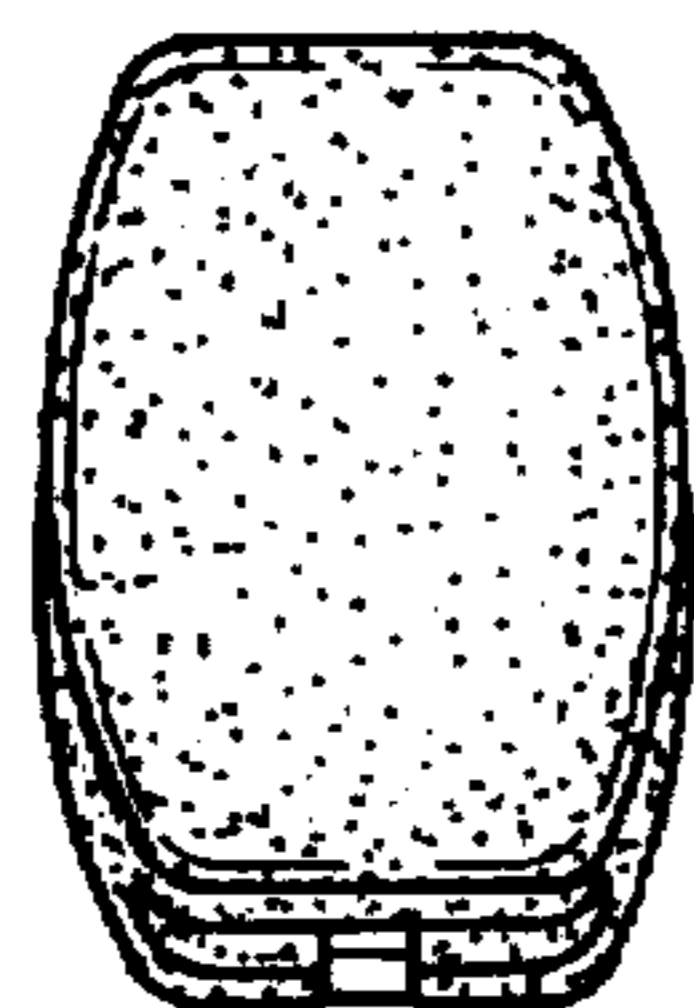

FIG. 7

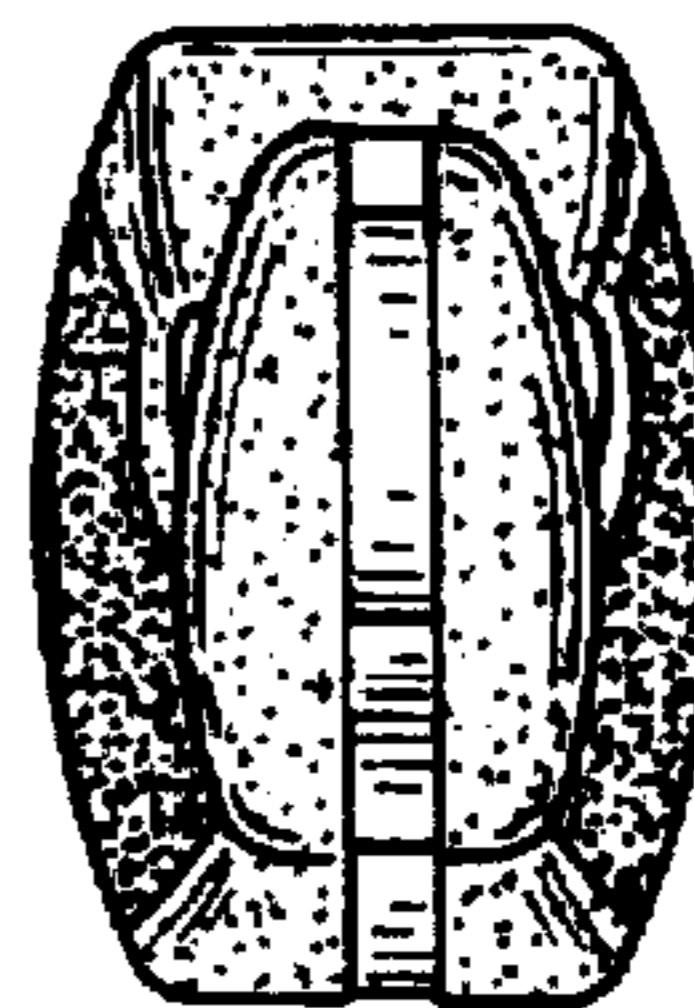

FIG. 8