



US00D392522S

United States Patent [19]
Kenyon

[11] **Patent Number: Des. 392,522**
[45] **Date of Patent: **Mar. 24, 1998**

[54] **SNOW SHOVEL**

[76] **Inventor: Alan M. Kenyon, 208 Shasta Ave., Mt. Shasta, Calif. 96067**

[**] **Term: 14 Years**

[21] **Appl. No.: 62,548**

[22] **Filed: Nov. 18, 1996**

[51] **LOC (6) Cl. 08-01**

[52] **U.S. Cl. D8/10**

[58] **Field of Search D8/1, 7, 9-11, D8/16; D32/40, 46, 49; 15/236.01, 236.07, 245, 245.1; 30/169, 171; 37/264-266, 278, 284, 285; 294/49, 54.5, 55**

[56] **References Cited**

U.S. PATENT DOCUMENTS

815,122	3/1906	Schaffert	294/54.5 X
1,743,161	1/1930	Prindle	37/284
2,114,641	4/1938	Stevenson	37/284
2,165,314	7/1939	Stevenson	37/284
4,199,181	4/1980	Mason	37/284

Primary Examiner—Alan P. Douglas
Assistant Examiner—Lavone D. Tabor
Attorney, Agent, or Firm—Thomas R. Lampe

[57] **CLAIM**

The ornamental design for snow shovel, as shown and described.

DESCRIPTION

FIG. 1 is a front perspective view of snow shovel showing my design;
FIG. 2 is a top plan view thereof;
FIG. 3 is a front view thereof;
FIG. 4 is a rear view thereof;
FIG. 5 is a bottom view thereof;
FIG. 6 is a left side view thereof;
FIG. 7 is a right side view thereof;
FIG. 8 is a front perspective view of an alternate embodiment showing my design;
FIG. 9 is a top plan view thereof;
FIG. 10 is a front view thereof;
FIG. 11 is a rear view thereof;
FIG. 12 is a bottom view thereof;
FIG. 13 is a left side view thereof; and,
FIG. 14 is a right side view thereof.
The broken line showing of a portion of a handle in FIGS. 1 and 8 of the drawing is for illustrative purposes only and forms no part of the claimed design.

1 Claim, 4 Drawing Sheets

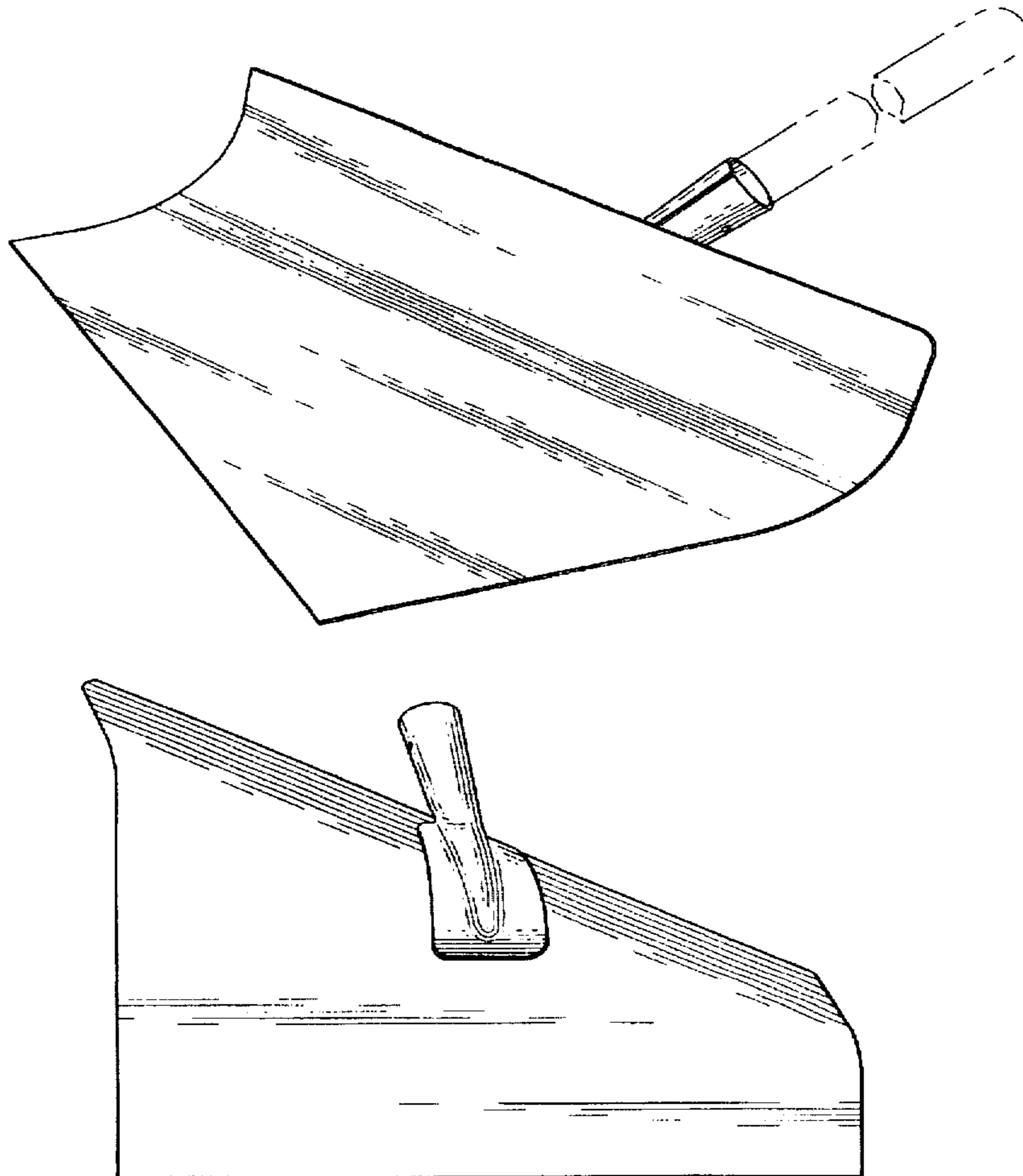

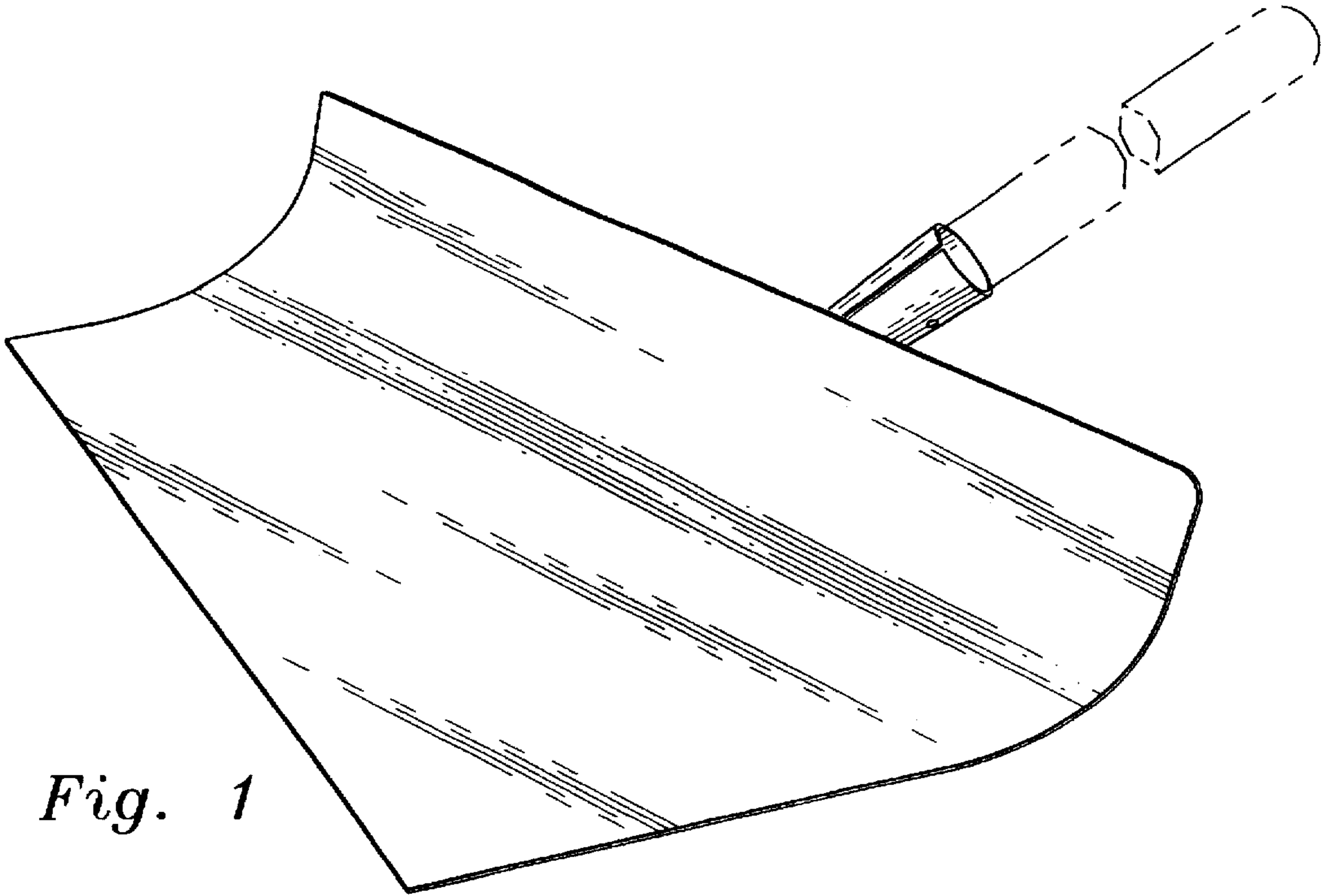

Fig. 1

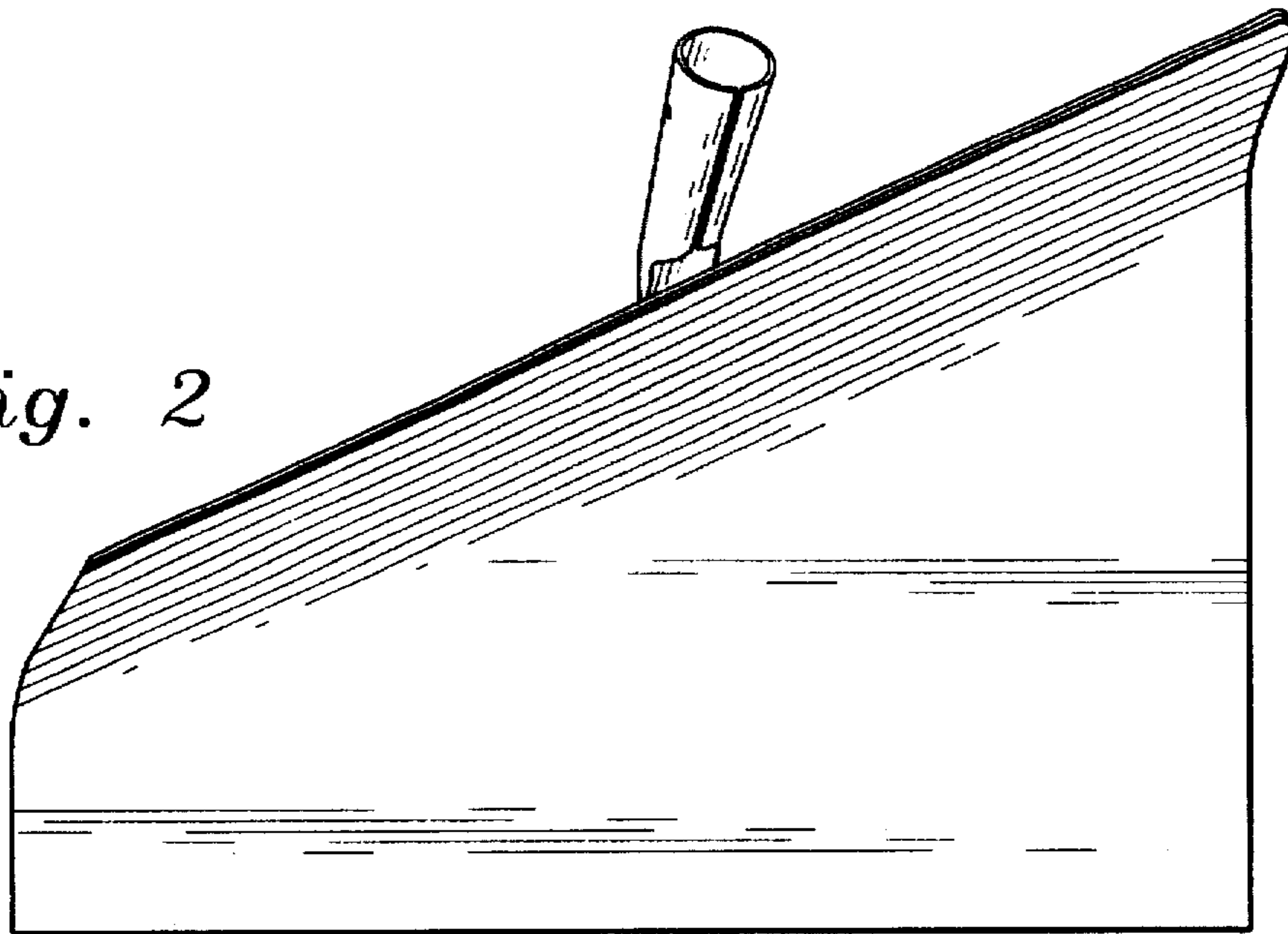

Fig. 2

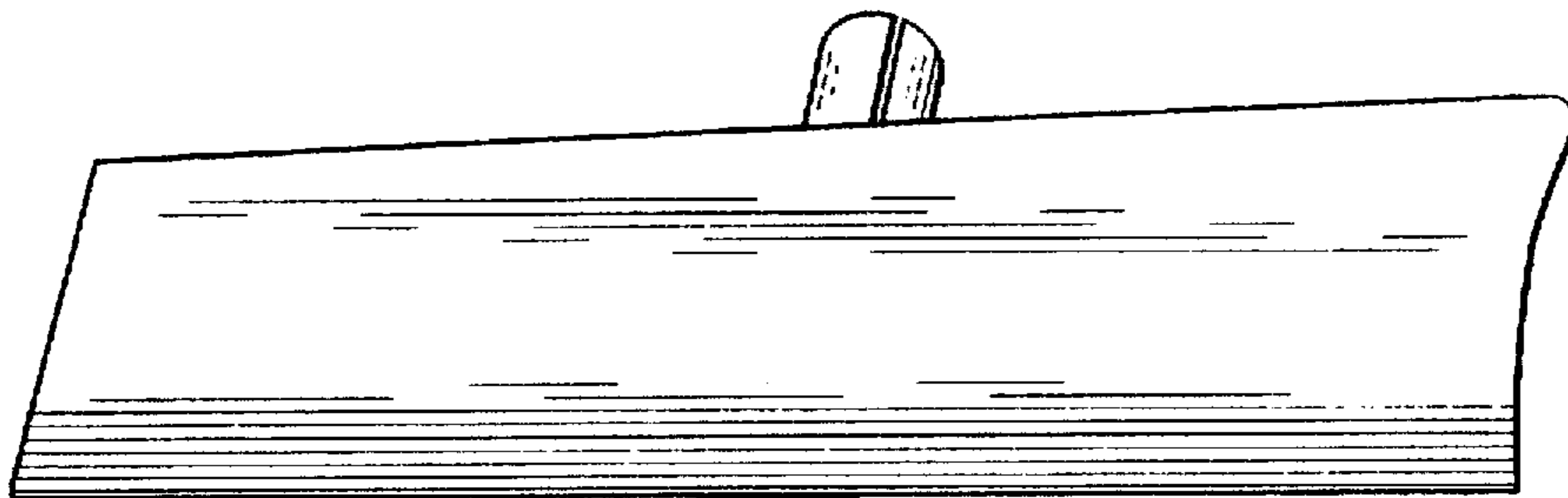

Fig. 3

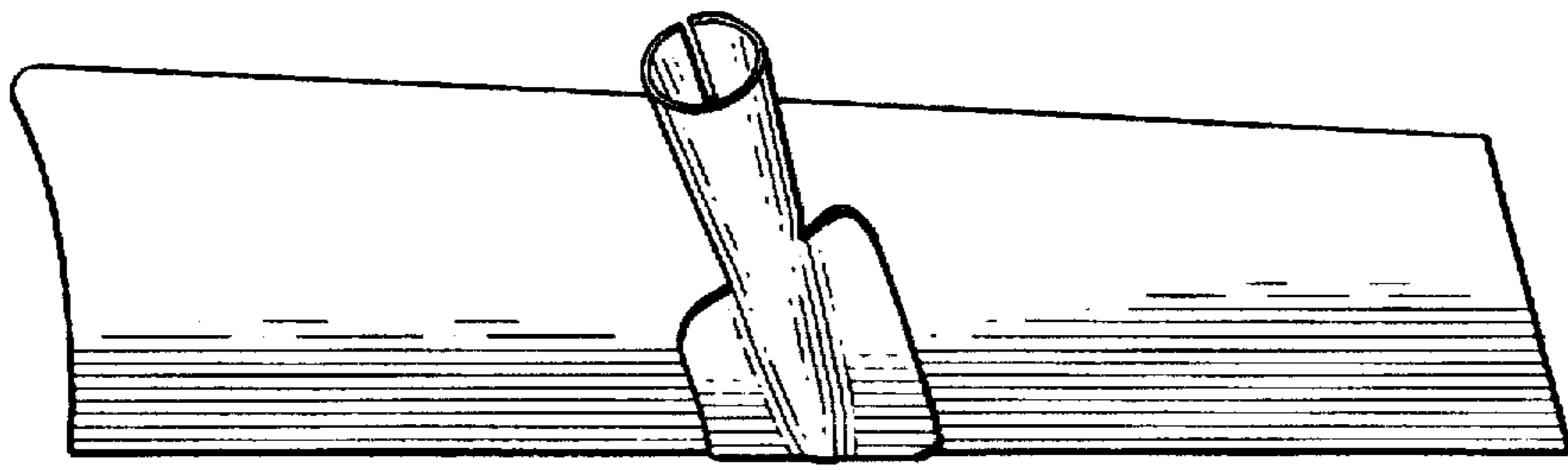

Fig. 4

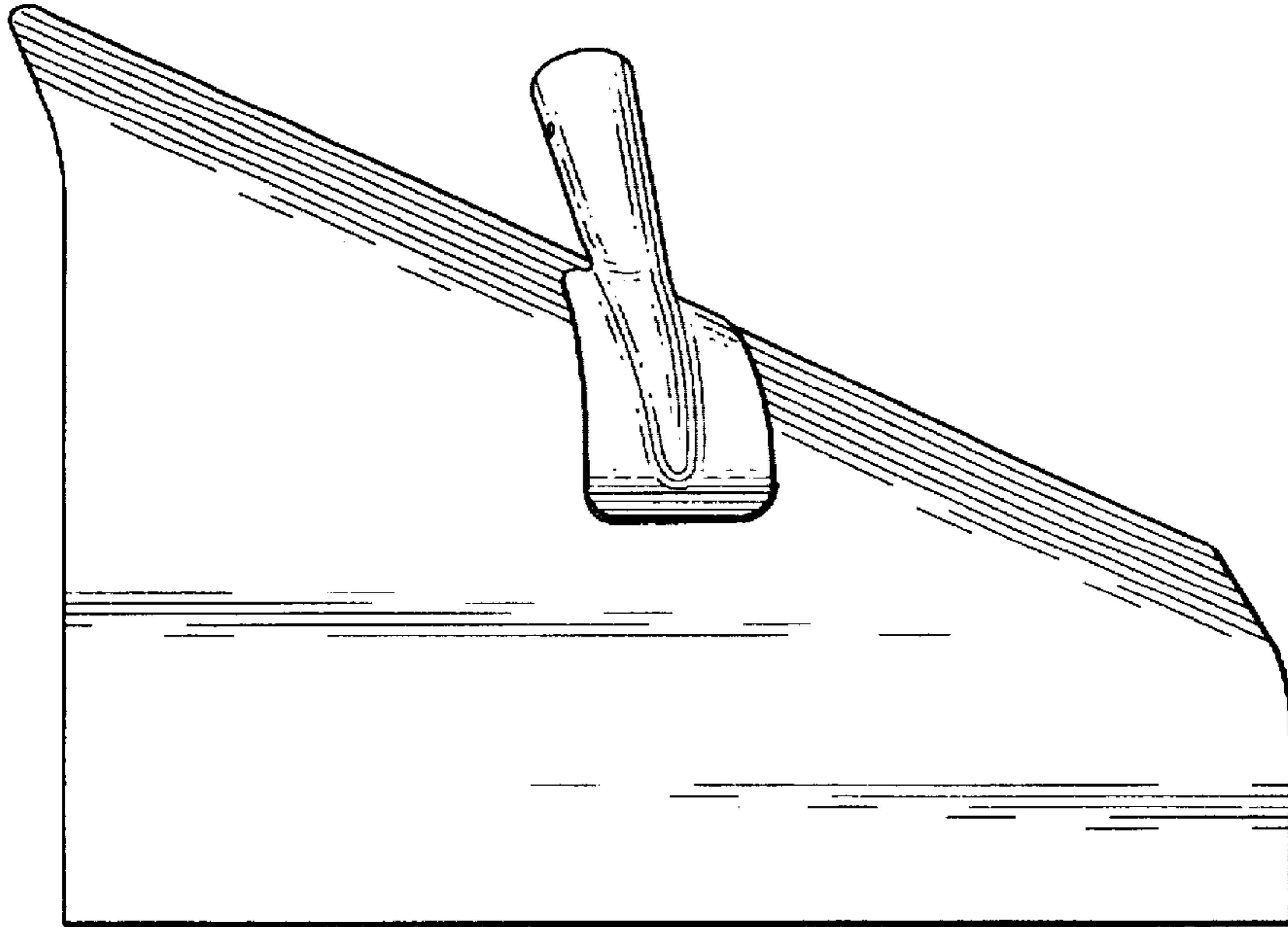

Fig. 5

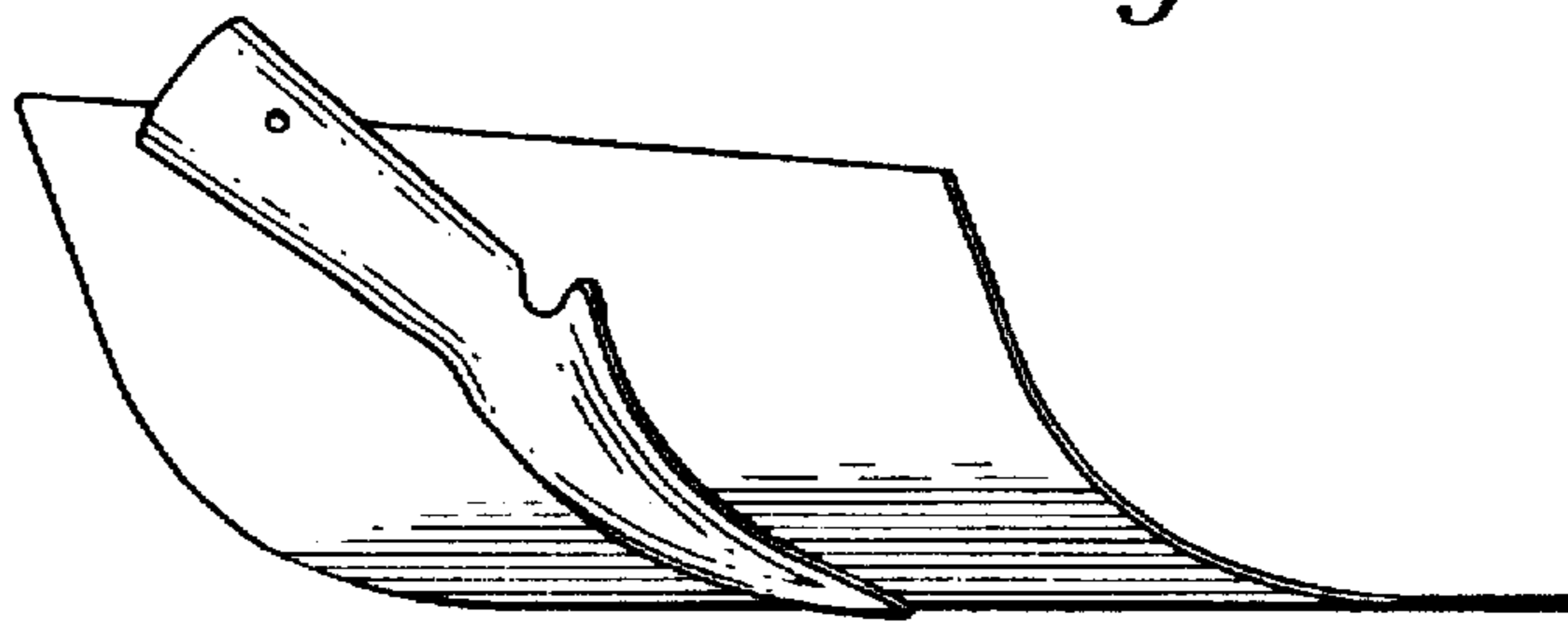

Fig. 6

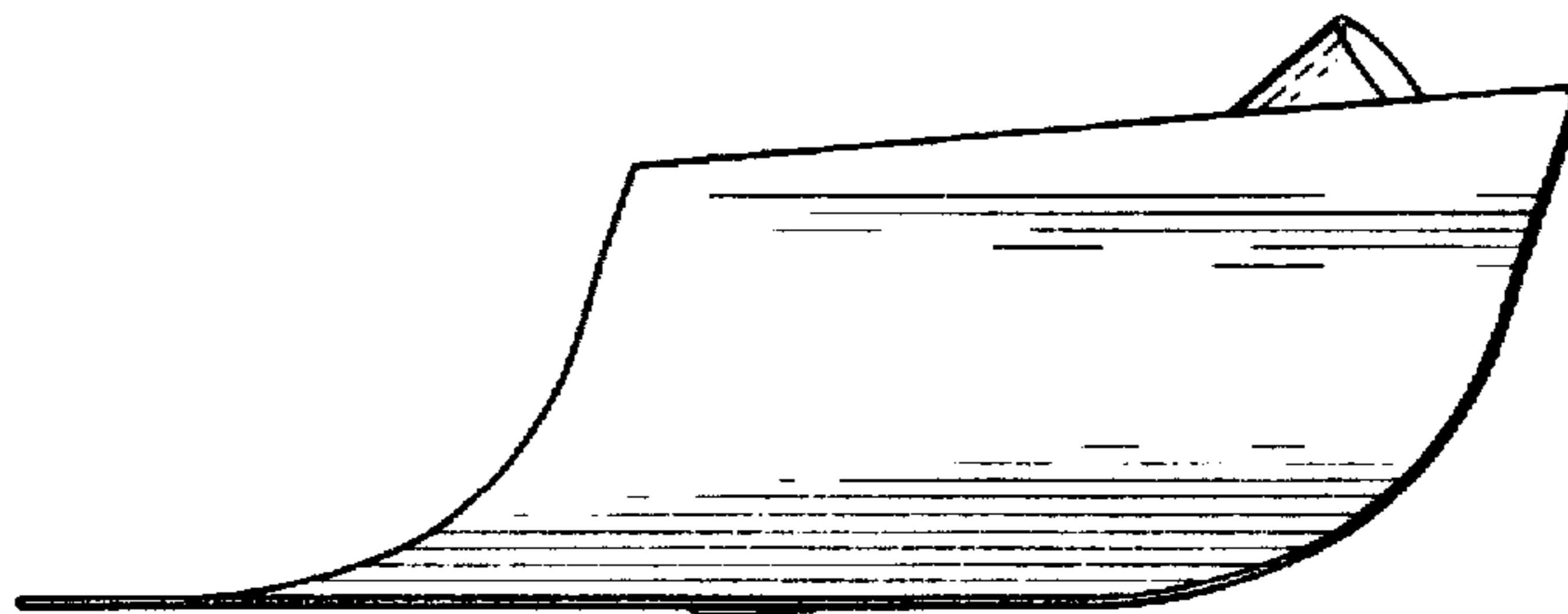

Fig. 7

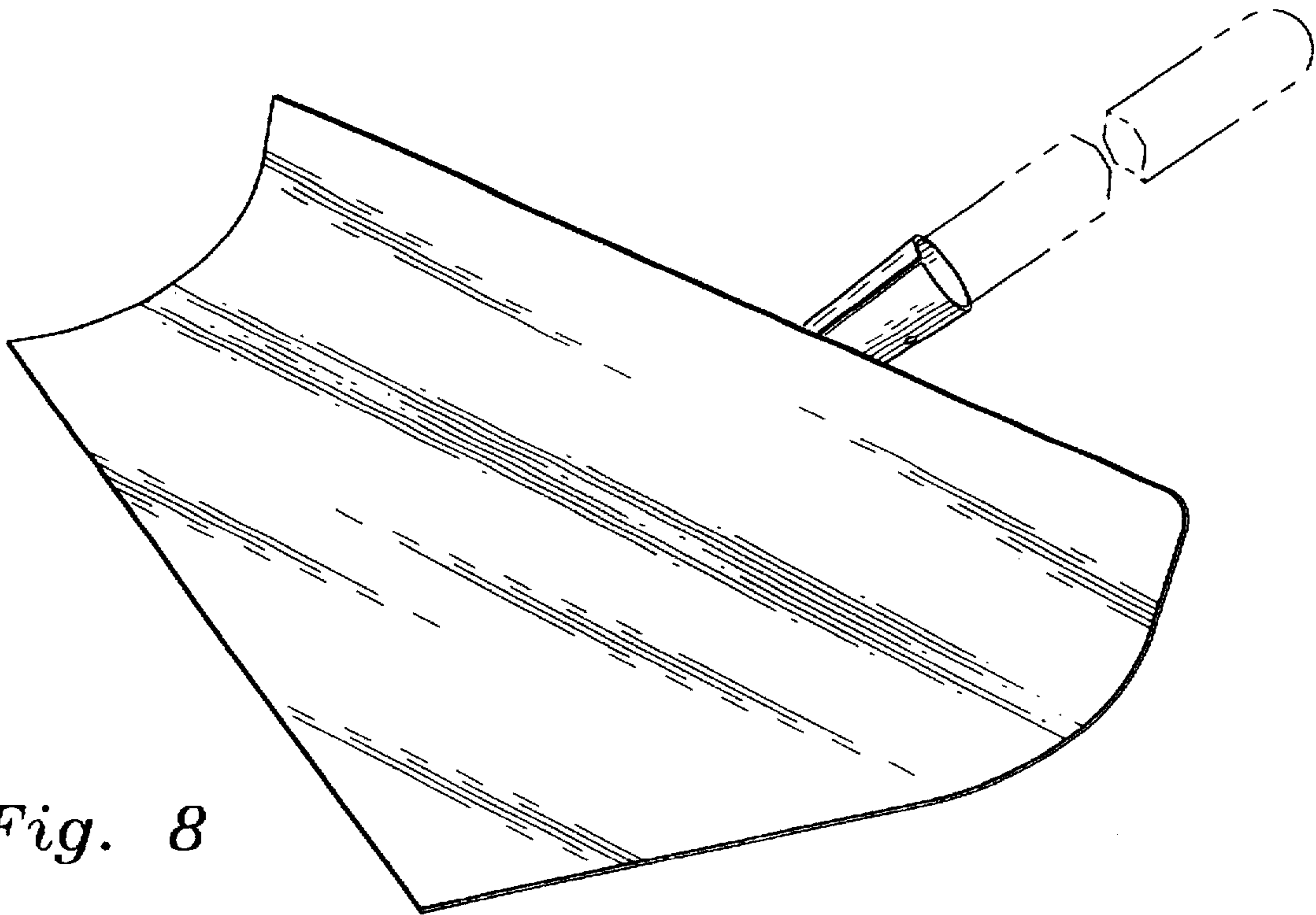

Fig. 8

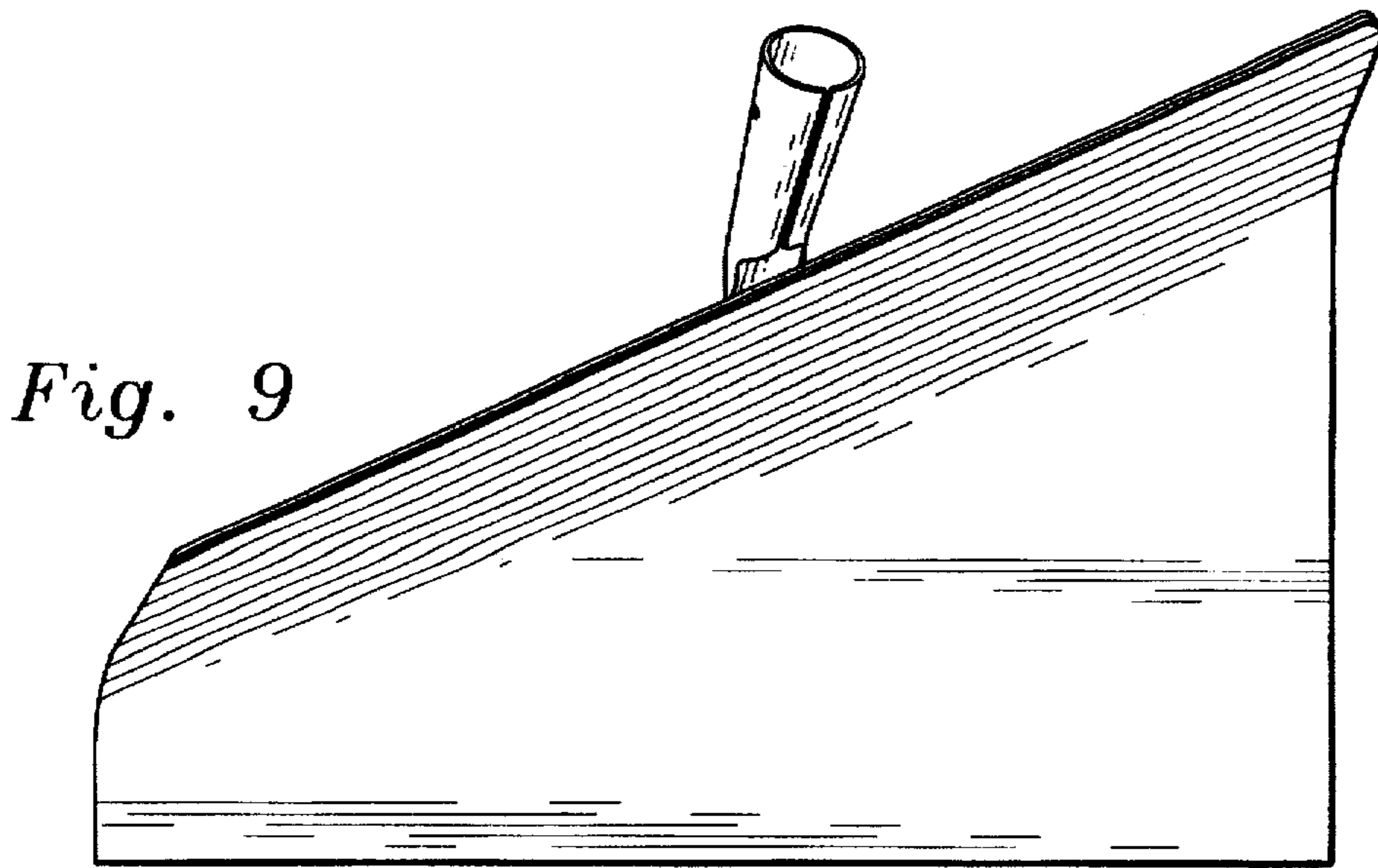

Fig. 9

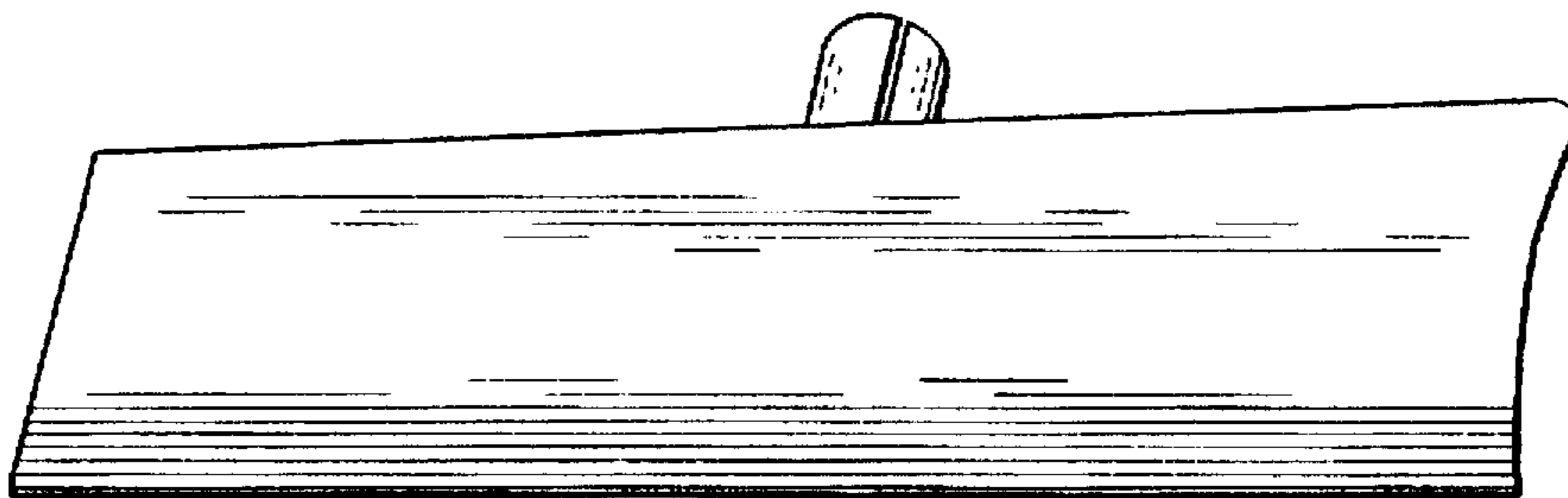

Fig. 10

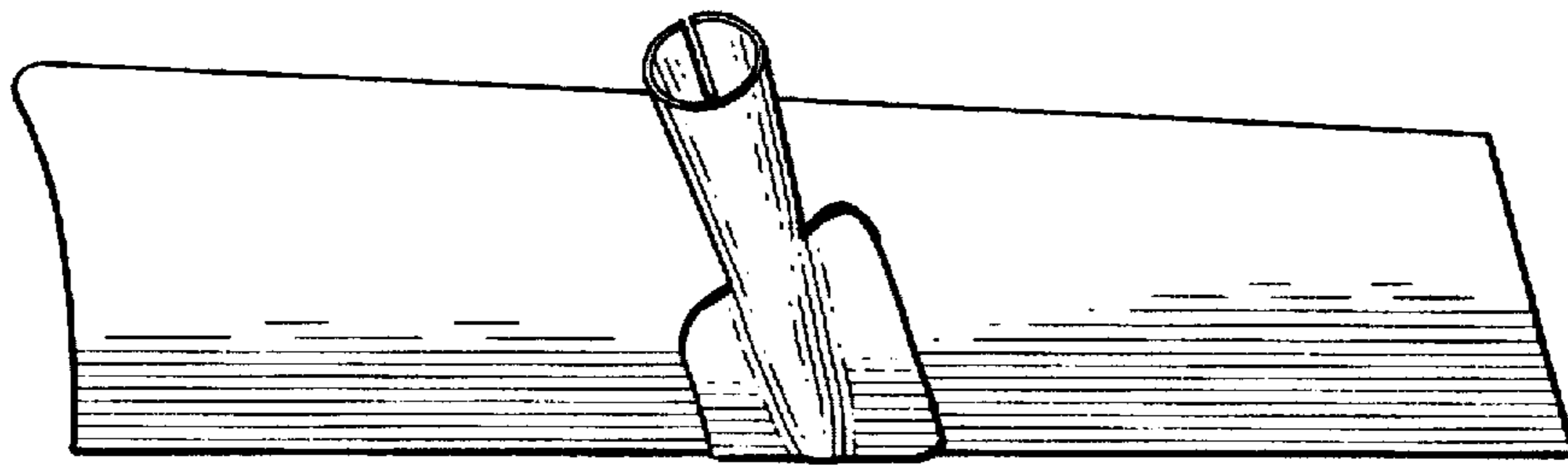

Fig. 11

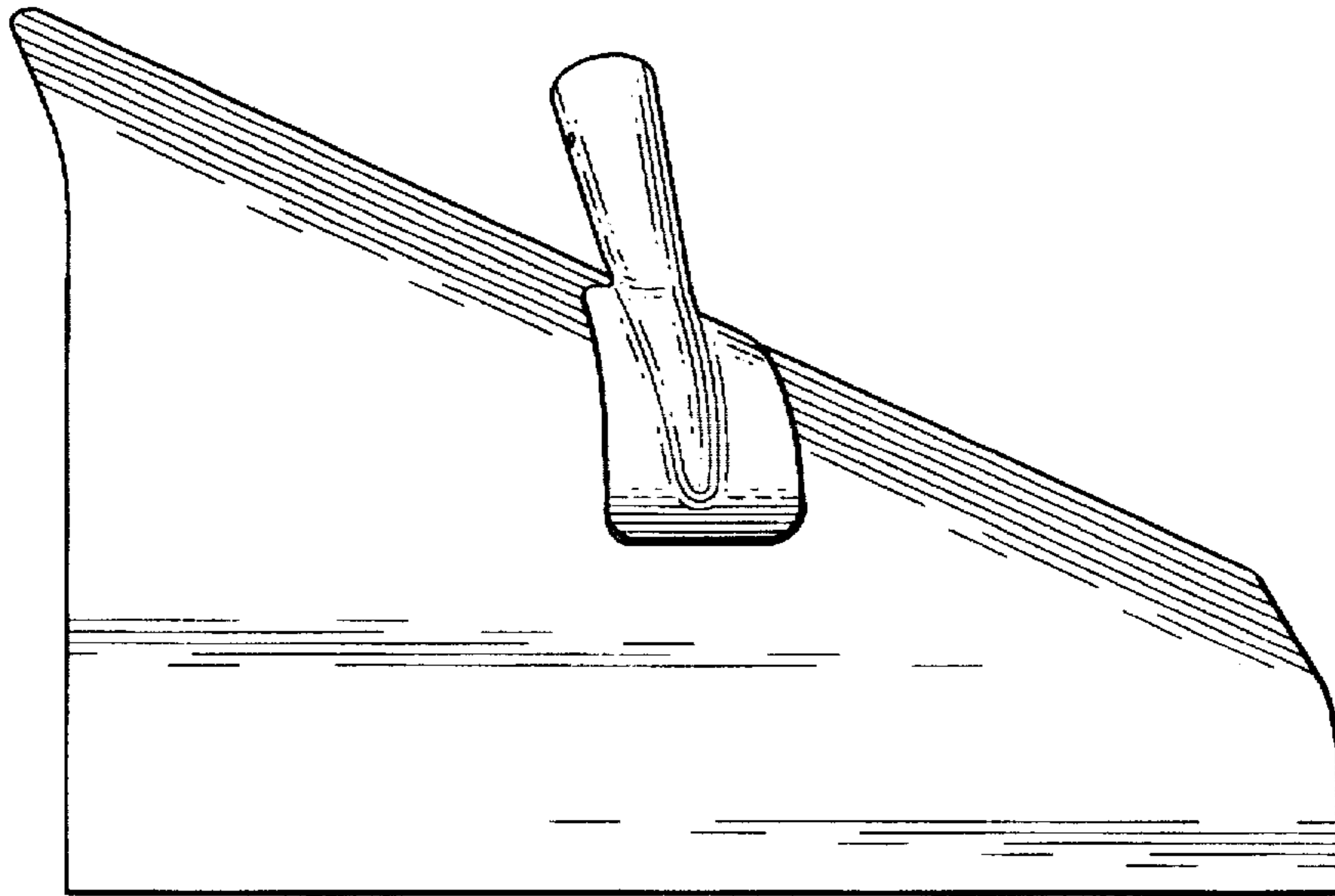

Fig. 12

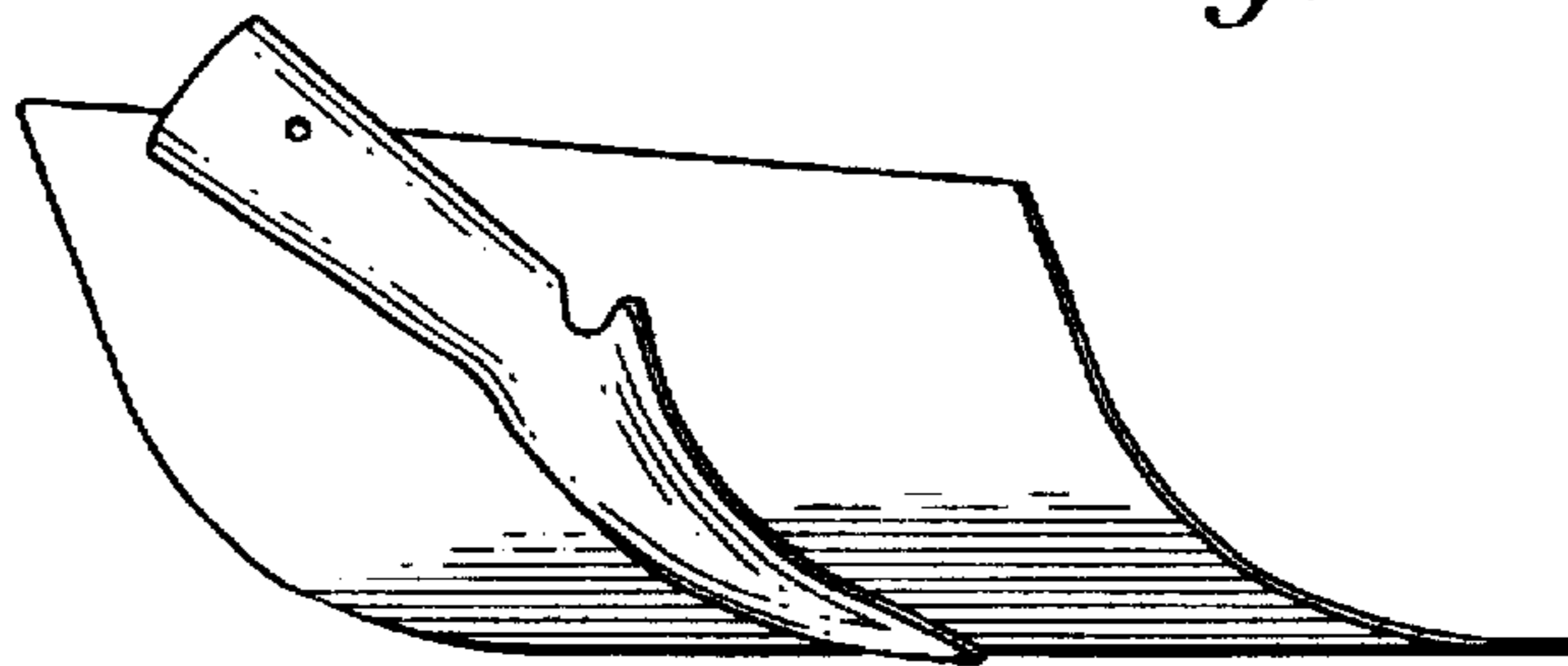

Fig. 13

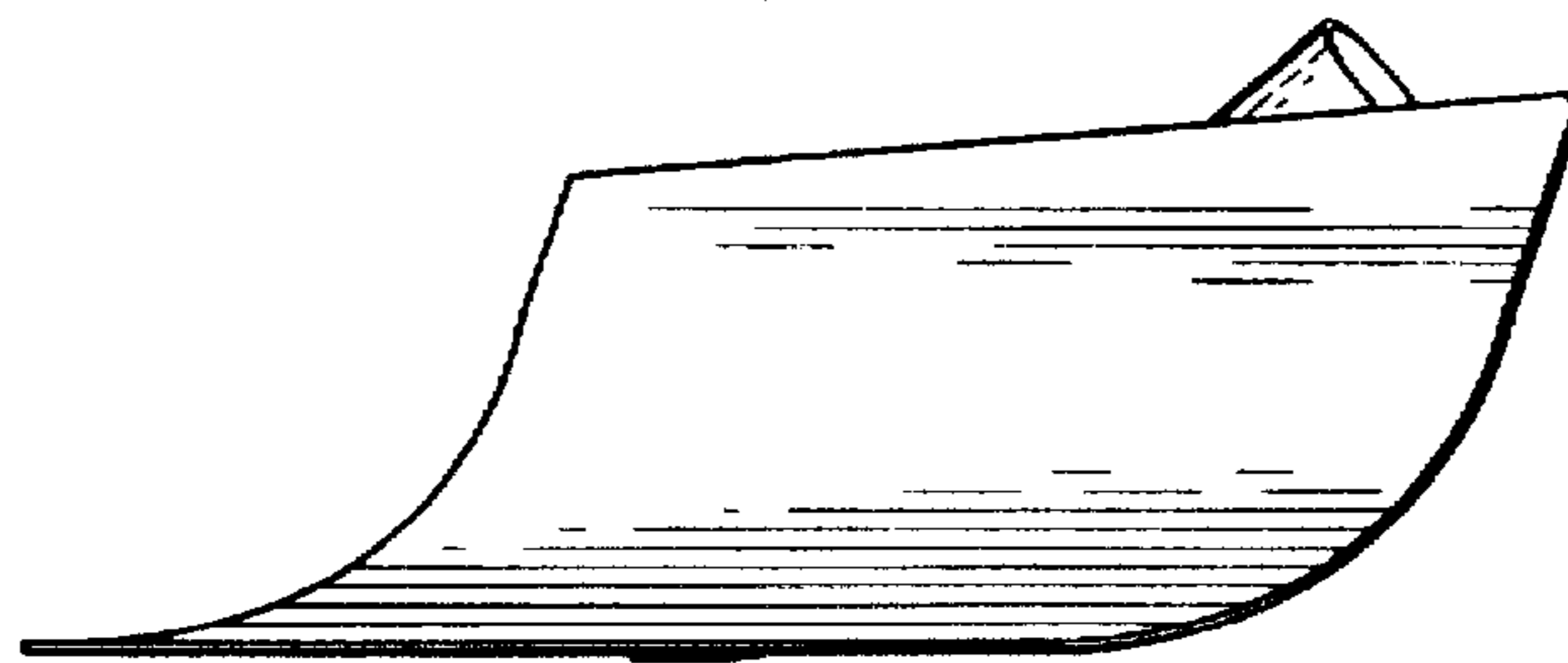

Fig. 14