



US00D392429S

# United States Patent [19]

Plewa et al.

[11] Patent Number: **Des. 392,429**

[45] Date of Patent: **\*\*Mar. 17, 1998**

[54] **HOUSING FOR A RETRACTABLE ANIMAL LEASH**

[75] Inventors: **Jens Plewa**, Hamburg, Germany;  
**Hartmut Esslinger**, Los Gatos, Calif.

[73] Assignee: **Bogdahn-Technik GmbH**, Bargtheide, Germany

[\*\*] Term: **14 Years**

[21] Appl. No.: **42,053**

[22] Filed: **Jul. 31, 1995**

[30] **Foreign Application Priority Data**

Jan. 31, 1995 [DE] Germany ..... 95 00 613.3

[51] LOC (6) Cl. .... **30-09**

[52] U.S. Cl. .... **D30/153**

[58] Field of Search ..... 119/794, 796;  
D30/152-153

[56] **References Cited**

**U.S. PATENT DOCUMENTS**

- D. 125,944 3/1941 Stickwell ..... D30/153
- D. 198,757 7/1964 Rogers ..... D30/153
- D. 274,379 6/1984 Talo ..... D30/153
- 2,314,504 3/1943 Lifchultz ..... 119/796

- 2,919,676 1/1960 Schneider ..... 119/796
- 3,099,250 7/1963 Soles, Jr. .... 119/776
- 3,693,596 9/1972 Croce et al. .... 119/796
- 3,853,283 12/1974 Croce et al. .... 119/796
- 4,562,792 1/1986 Pak ..... 119/797
- 5,377,626 1/1995 Kilsby et al. .... 119/796
- 5,483,926 1/1996 Bogdahn ..... 119/796

**FOREIGN PATENT DOCUMENTS**

- 8201744 11/1982 Netherlands ..... 119/796

*Primary Examiner*—Cathy Anne MacCormac  
*Attorney, Agent, or Firm*—Fay, Sharpe, Beall, Fagan, Minnich & McKee

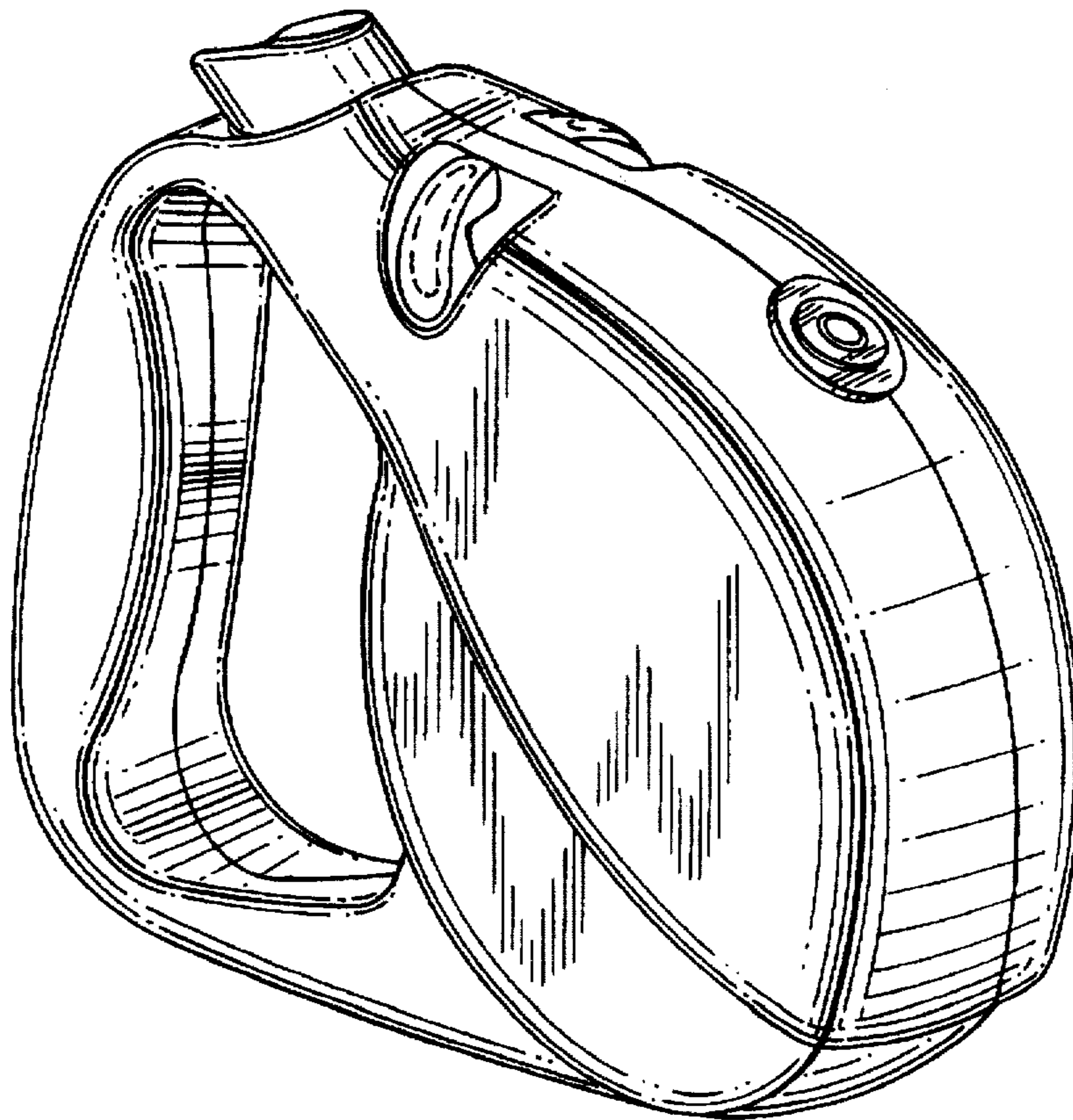
[57] **CLAIM**

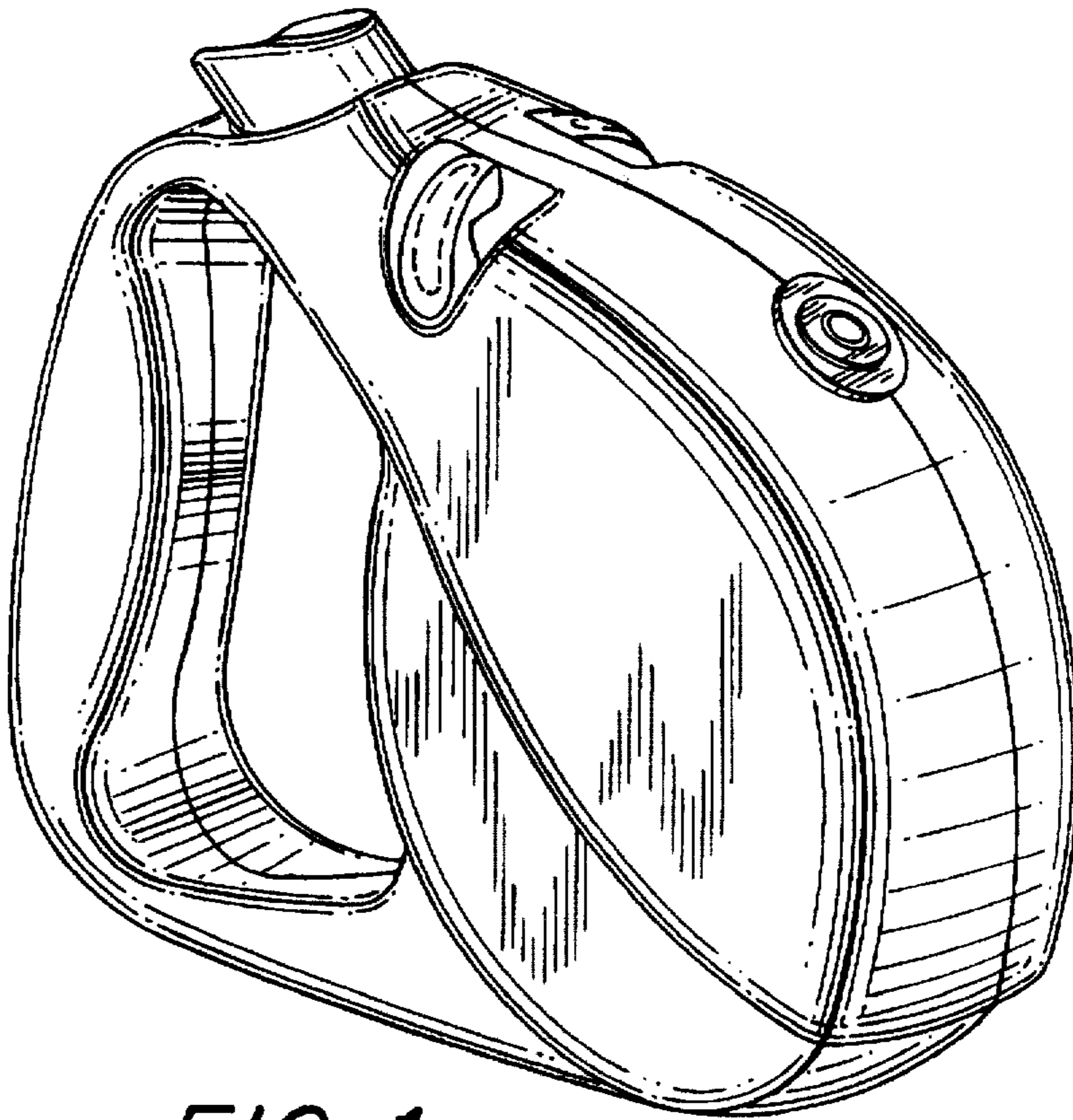
The ornamental design for a housing for a retractable animal leash, as shown and described.

**DESCRIPTION**

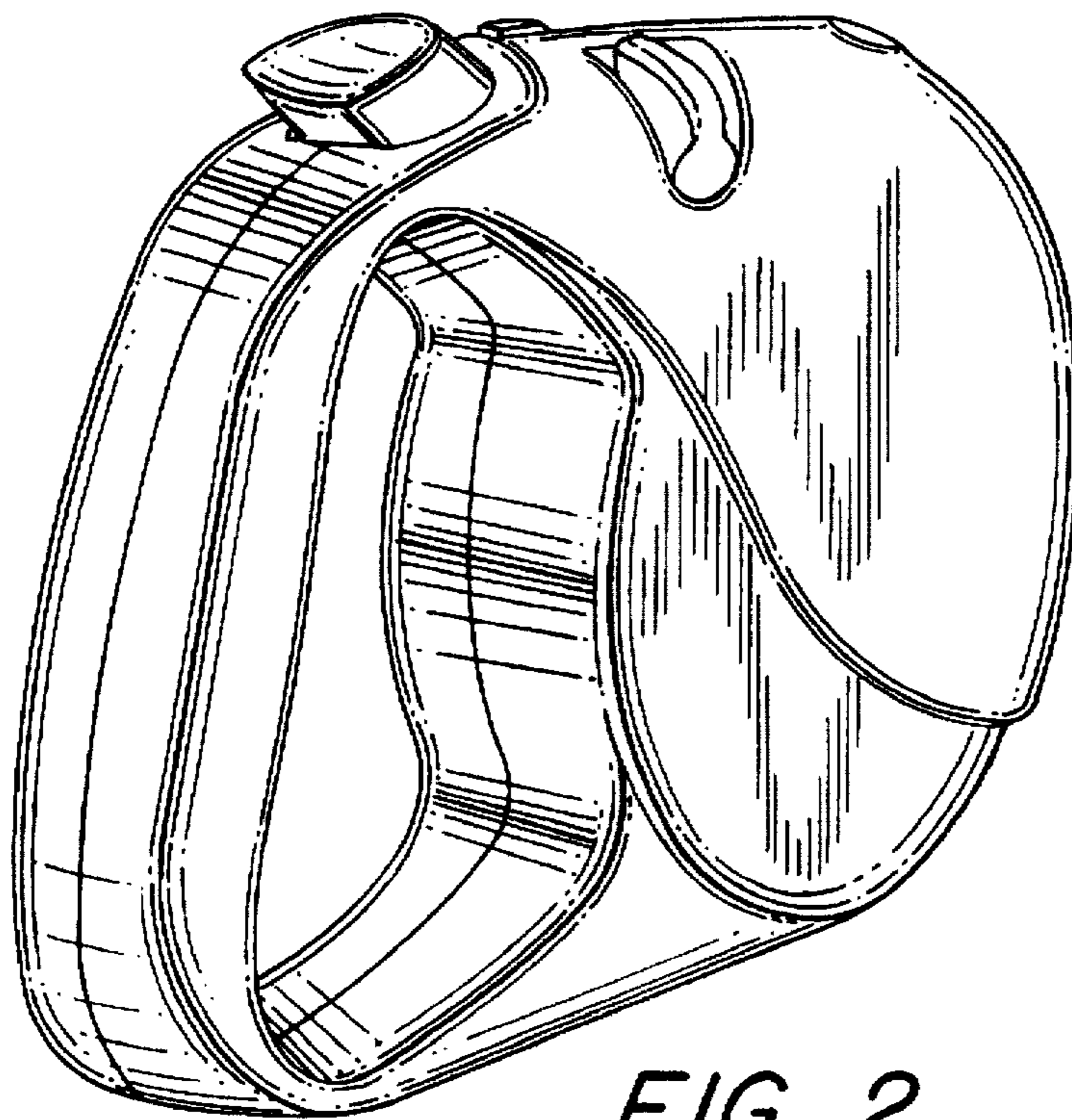
FIG. 1 is a front perspective view of a housing for a retractable animal leash showing our new design; FIG. 2 is a rear perspective view thereof; FIG. 3 is a left elevational view thereof; FIG. 4 is a right elevational view thereof; FIG. 5 is a top plan view thereof; FIG. 6 is a rear elevational view thereof; and FIG. 7 is a front elevational view thereof.

**1 Claim, 3 Drawing Sheets**

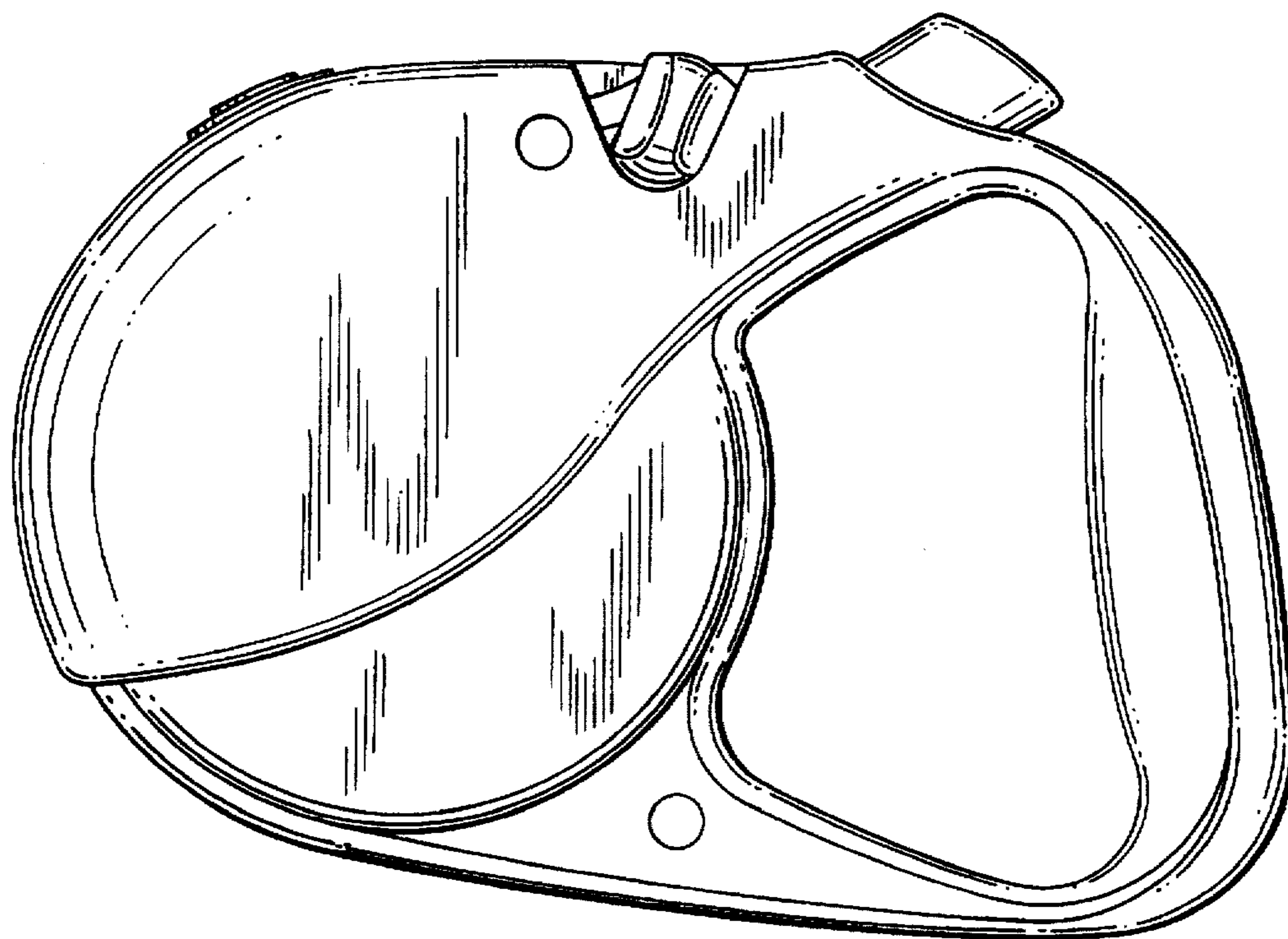




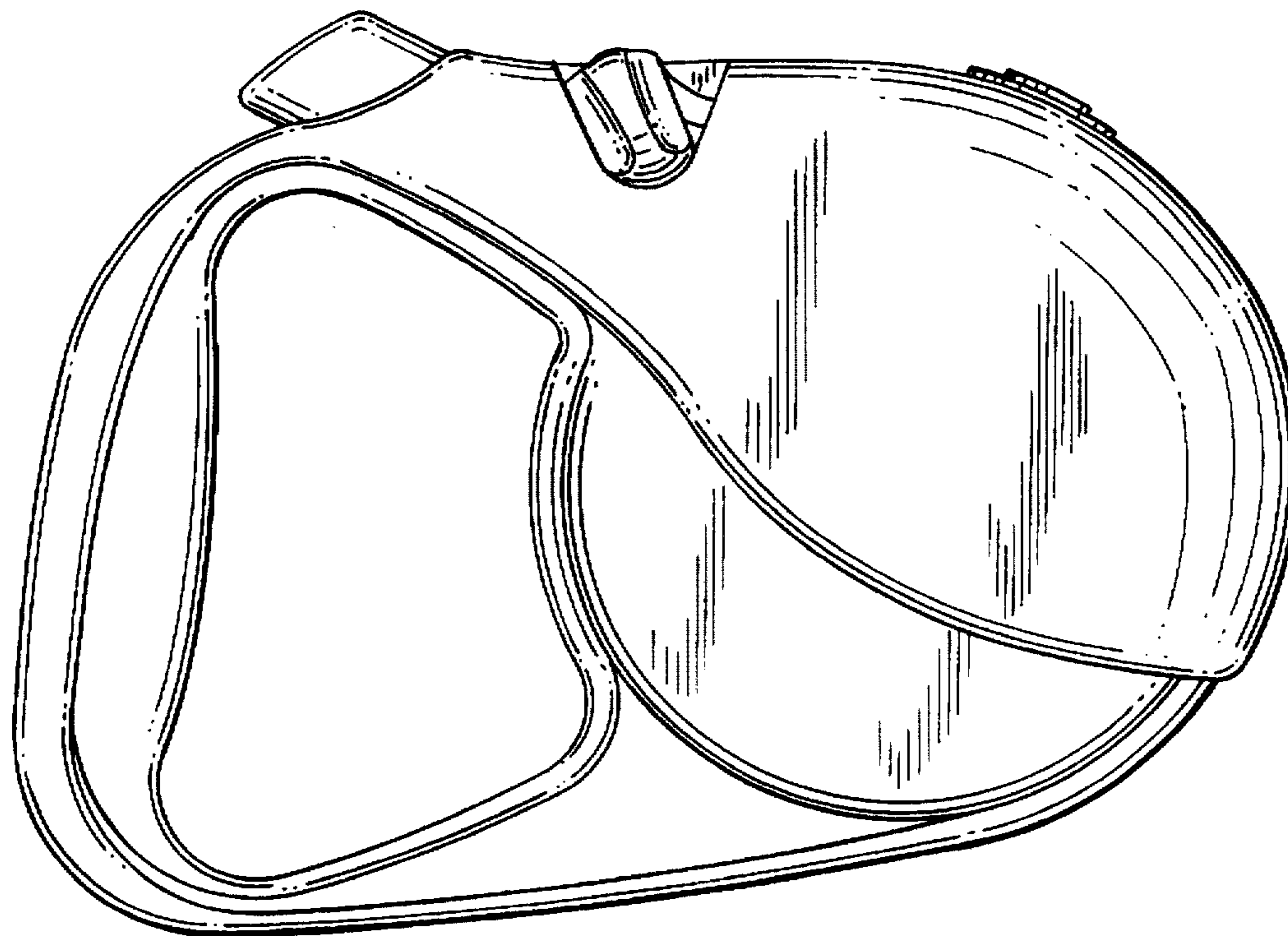
*FIG. 1*



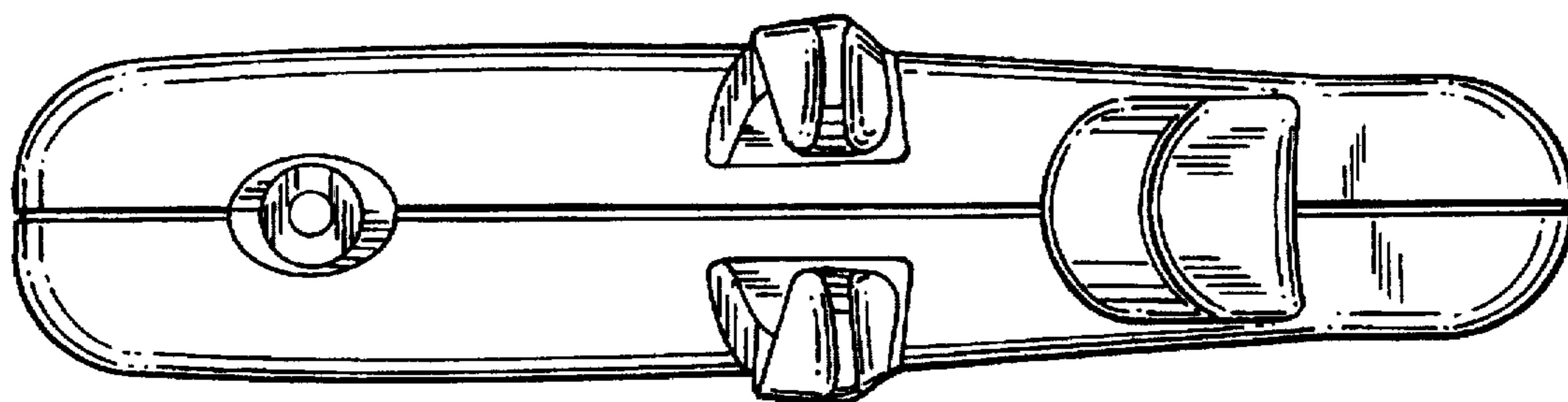
*FIG. 2*



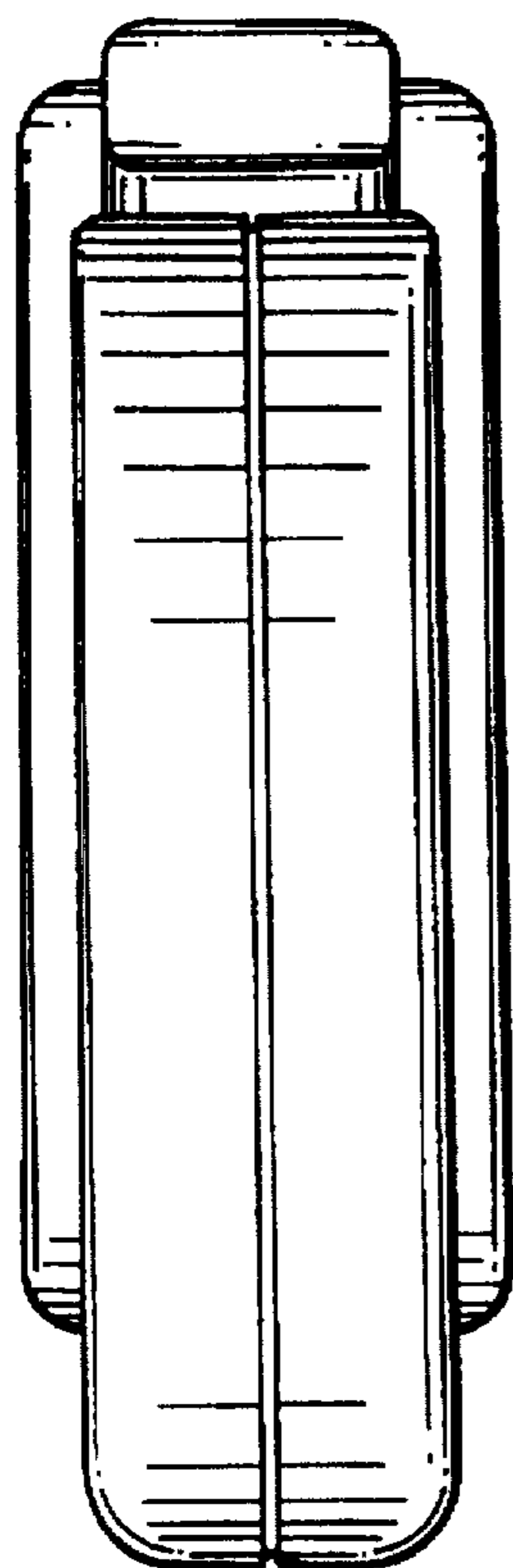
*FIG. 3*



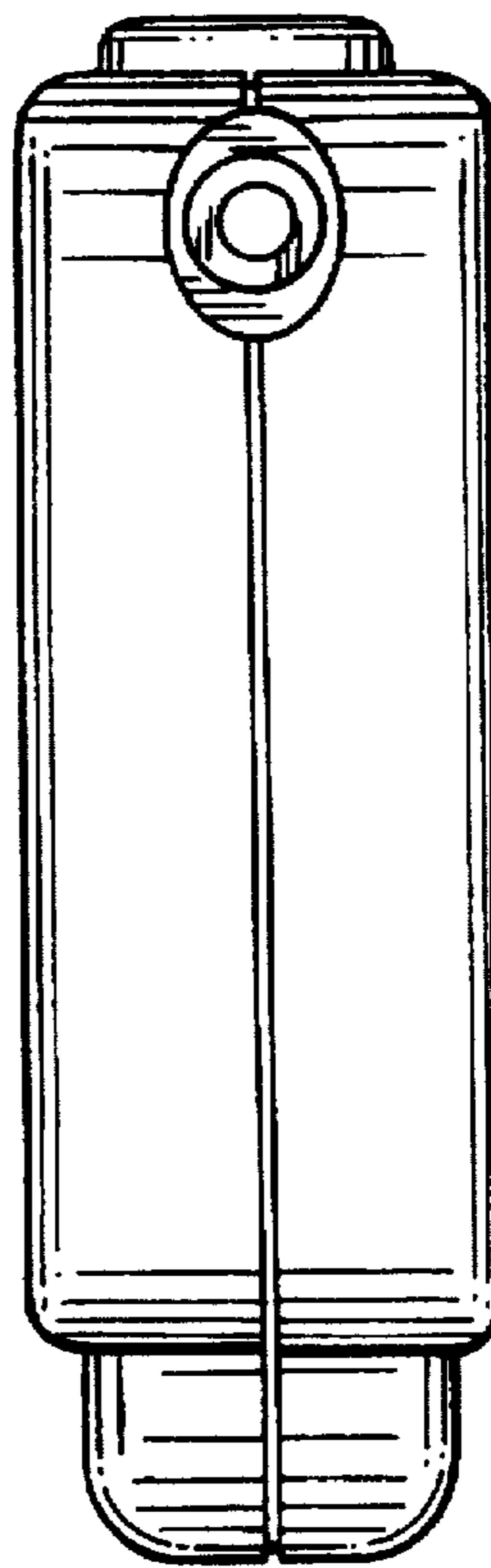
*FIG. 4*



*FIG. 5*



*FIG. 6*



*FIG. 7*