



US00D392428S

United States Patent [19]
Atchley

[11] **Patent Number: Des. 392,428**
[45] **Date of Patent: **Mar. 17, 1998**

[54] **COMBINED FOOD HOPPER AND DISPENSER FOR SMALL ANIMALS**

5,423,291 6/1995 Daugherty 119/52.2
5,479,879 1/1996 Biek 119/52.2
5,555,843 9/1996 Harman 119/57.8

[75] Inventor: **Frank Atchley, Napa, Calif.**

FOREIGN PATENT DOCUMENTS

[73] Assignee: **Lixit Corporation, Napa, Calif.**

002669507 5/1992 France 119/57.8
0410220 5/1934 United Kingdom 119/57.8
2154416 9/1985 United Kingdom 119/57.9
2222928 3/1990 United Kingdom 119/57.8

[**] Term: **14 Years**

[21] Appl. No.: **62,421**

Primary Examiner—Cathy Anne MacCormac
Attorney, Agent, or Firm—Harris Zimmerman, Esq.

[22] Filed: **Nov. 14, 1996**

[51] **LOC (6) Cl. 30-07**

[57] **CLAIM**

[52] **U.S. Cl. D30/121; D30/124**

The ornamental design for a combined food hopper and dispenser for small animals, as shown and described.

[58] **Field of Search D30/121, 129-132;**
119/51.5, 52.1, 52.2, 53, 57.8, 57.9, 59,
60-61, 63, 58, 71, 73-75, 77, 464, 475,
477, 706, 708, 710

DESCRIPTION

[56] **References Cited**

FIG. 1 is a perspective view of a combined food hopper and dispenser for small animals of the present invention;
FIG. 2 is a front elevational view;
FIG. 3 is a right hand side view, the left hand side view being a mirror image;
FIG. 4 is a bottom view;
FIG. 5 is a top view;
FIG. 6 is a rear elevational view; and,
FIG. 7 is an exploded perspective view with the parts disassembled.

U.S. PATENT DOCUMENTS

D. 175,133 7/1955 Siggins 119/464
3,276,630 10/1966 Welch 119/52.2
3,866,576 2/1975 Downing 119/477
4,315,483 2/1982 Scheidler 119/51.5
5,010,847 4/1991 Graden 119/475
5,062,388 11/1991 Kilham 119/52.2
5,113,795 5/1992 Delzio 119/706
5,307,760 5/1994 Madigan et al. 119/57.9

1 Claim, 2 Drawing Sheets

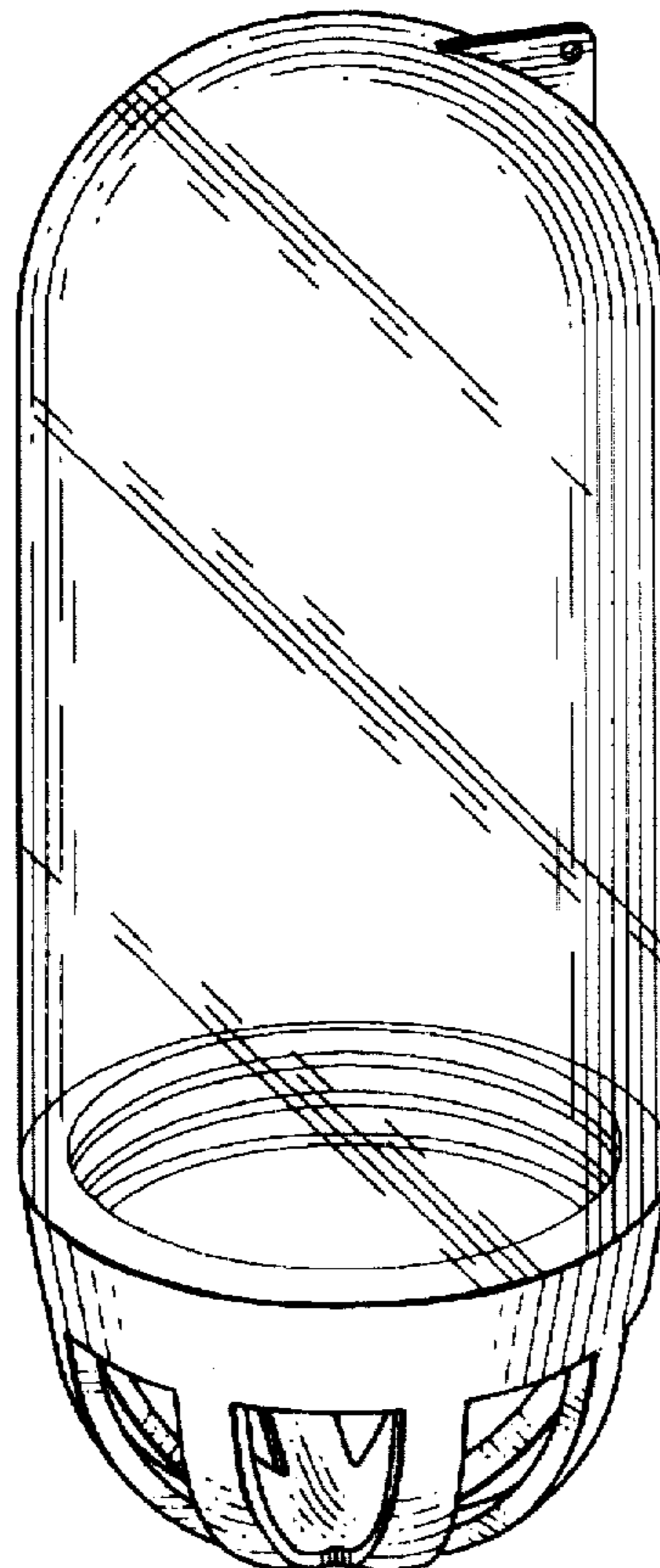

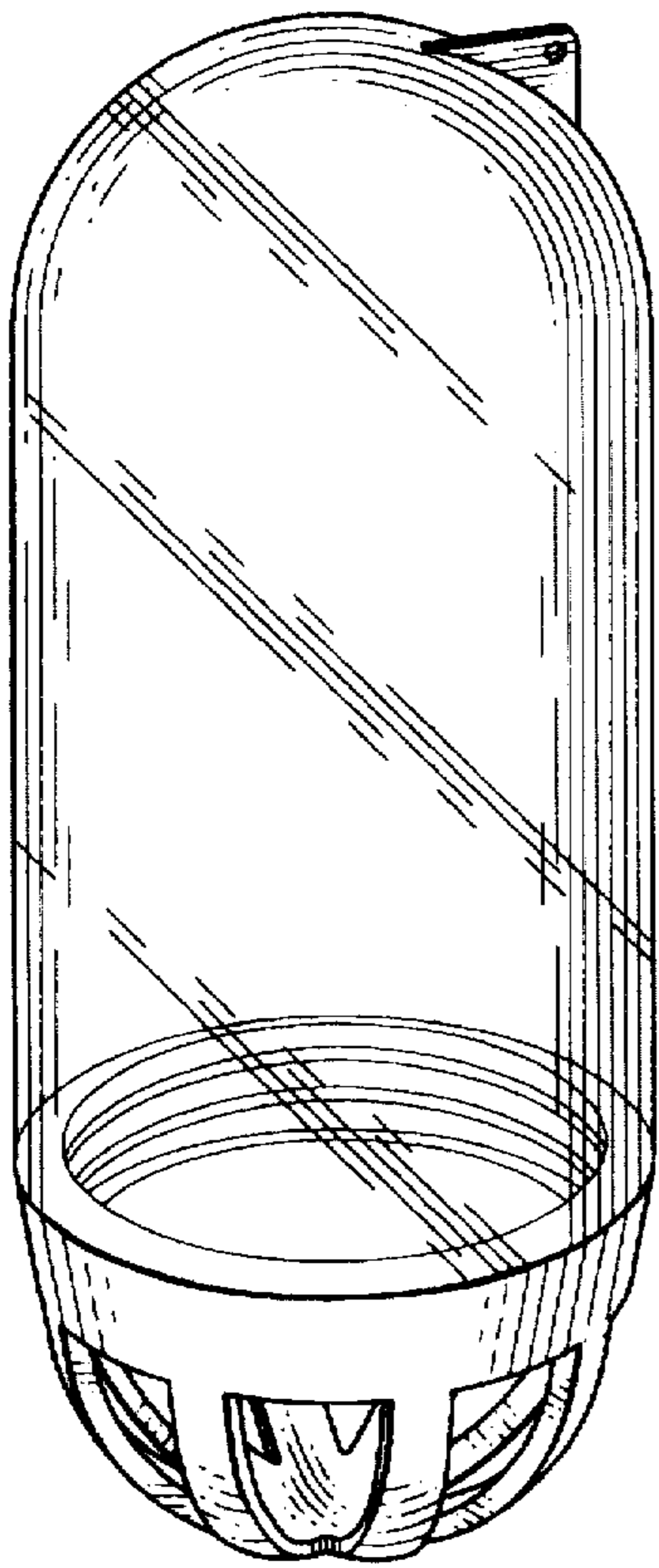

Fig. 1

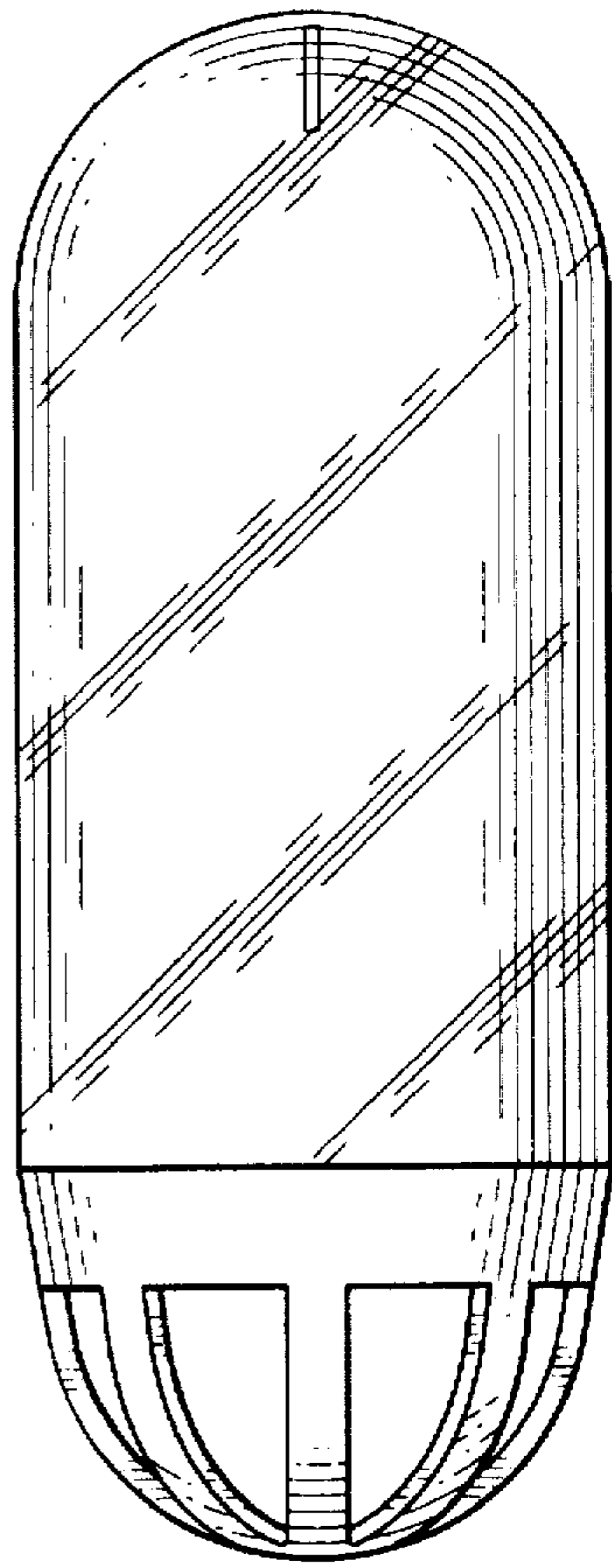

Fig. 2

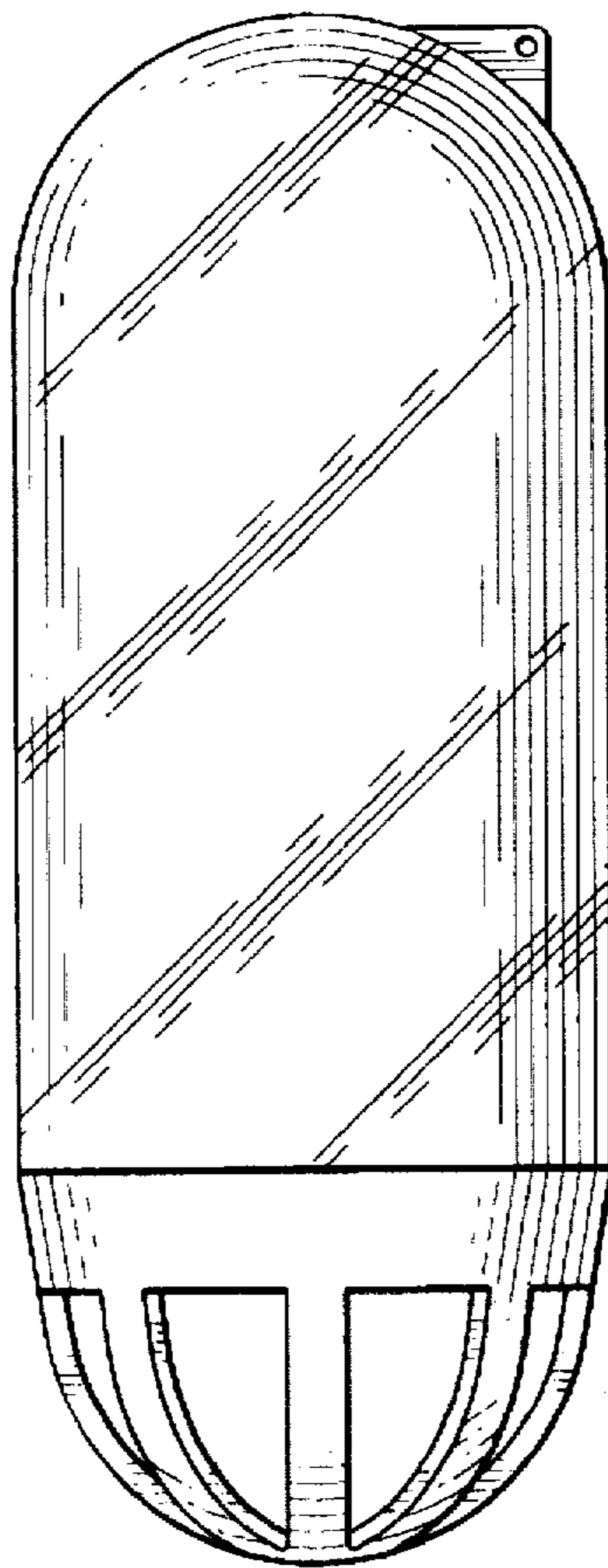

Fig. 3

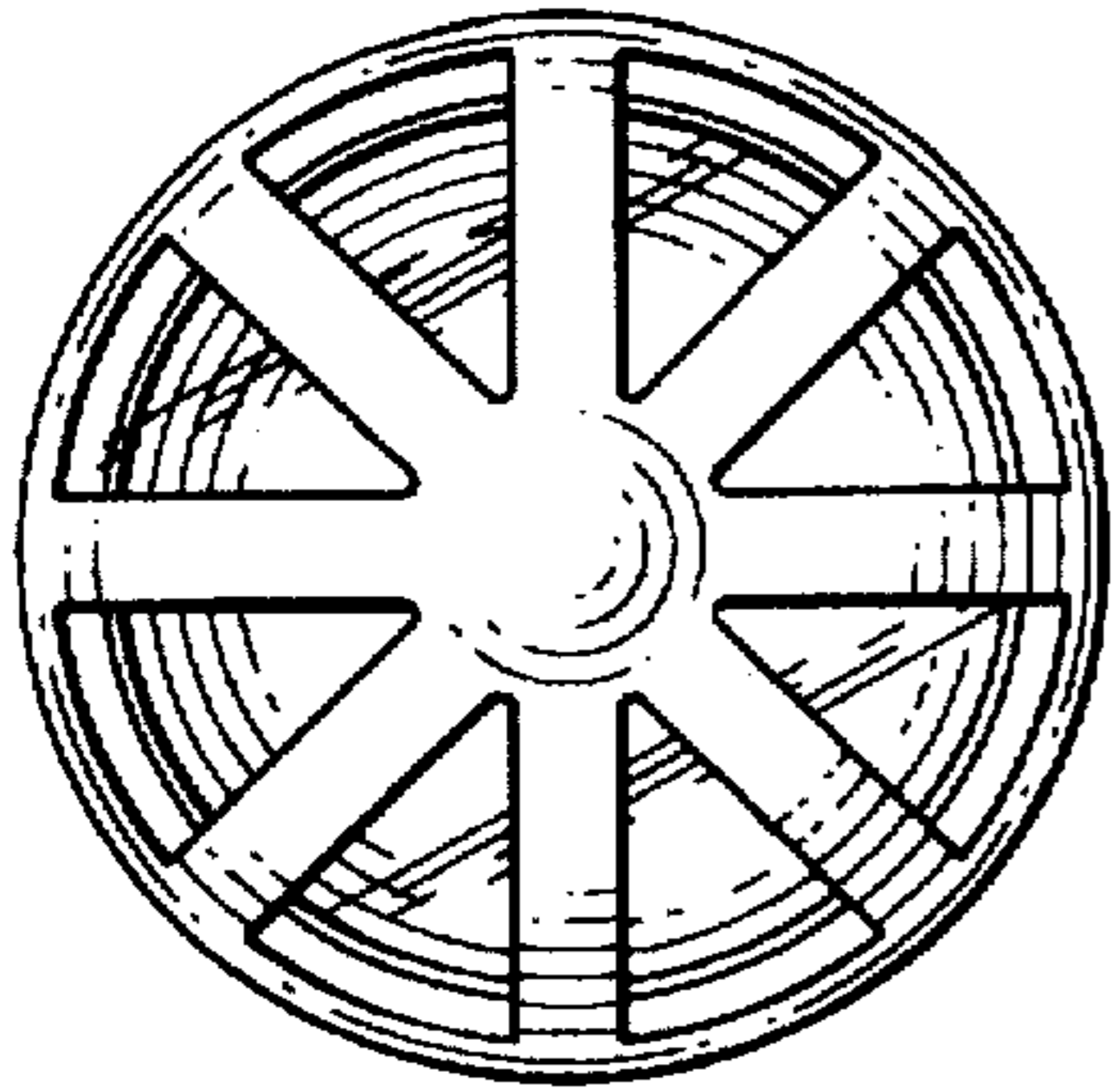

Fig. 4

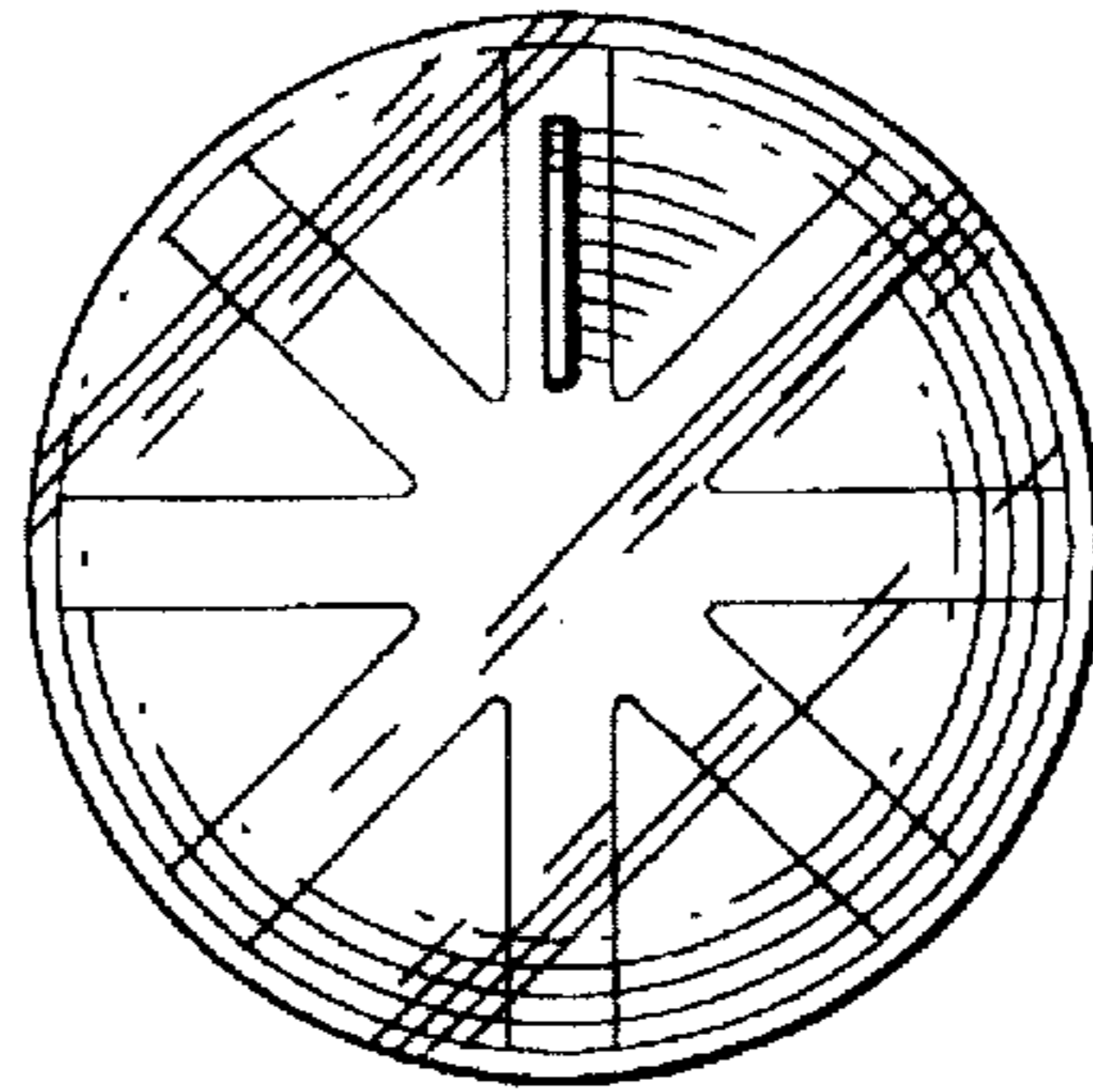

Fig. 5

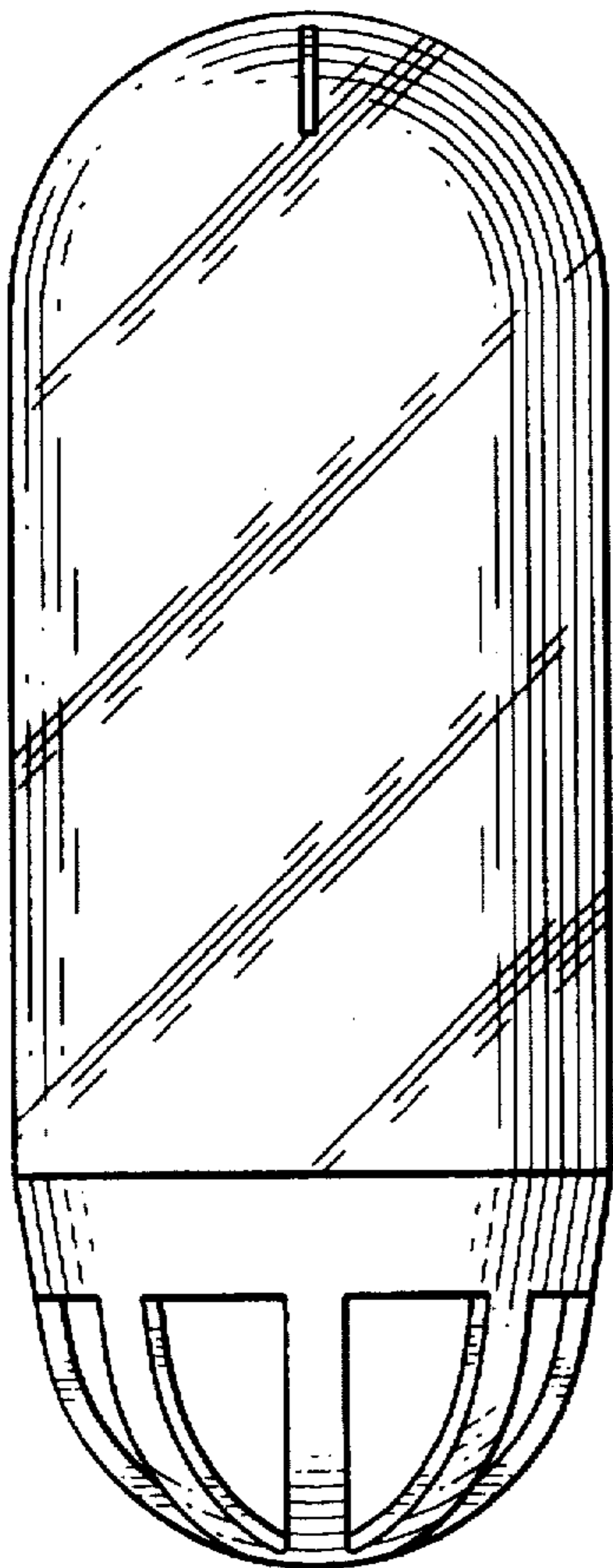

Fig. 6

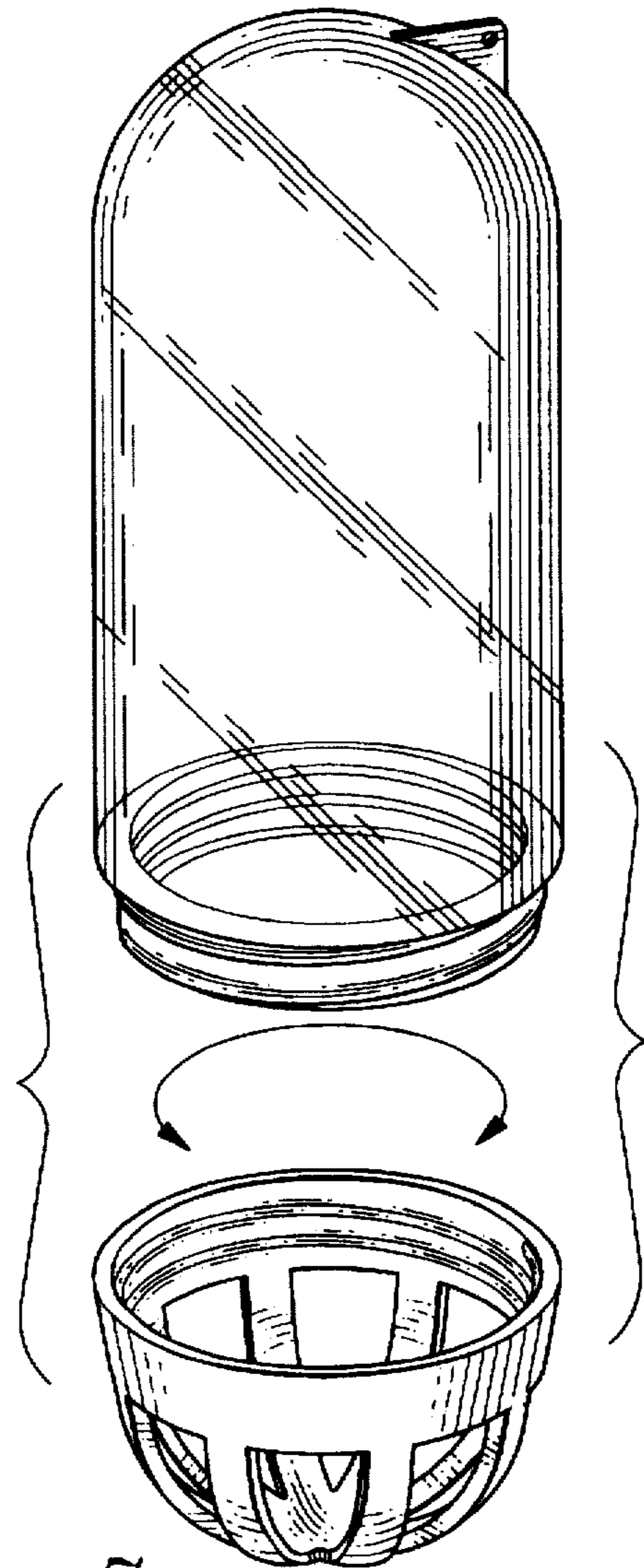

Fig. 7