



US00D392382S

United States Patent [19]

[11] **Patent Number:** **Des. 392,382**

Pickett

[45] **Date of Patent:** ****Mar. 17, 1998**

[54] **CEILING FAN**

Primary Examiner—Lisa Lichtenstein
Attorney, Agent, or Firm—Jenkins & Gilchrist, P.C.

[75] **Inventor:** **Mark Pickett**, Rancho Palos Verdes, Calif.

[57] **CLAIM**

[73] **Assignee:** **Minka Lighting, Inc.**, Corona, Calif.

The ornamental design for a ceiling fan, as shown and described.

[**] **Term:** **14 Years**

DESCRIPTION

[21] **Appl. No.:** **61,093**

FIG. 1 is a front top perspective view of a ceiling fan incorporating my ornamental design;

[22] **Filed:** **Oct. 16, 1996**

FIG. 2 is a front bottom perspective view of the ceiling fan of FIG. 1;

[51] **LOC (6) Cl.** **23-04**

FIG. 3 is a first side view of the ceiling fan of FIG. 1;

[52] **U.S. Cl.** **D23/377; D23/385; D23/411**

FIG. 4 is a second side view of the ceiling fan of FIG. 1;

[58] **Field of Search** **D23/377, 379,**

D23/385, 411; 392/364; 416/5; D7/576,
582

FIG. 5 is a third side view of the ceiling fan of FIG. 1;

FIG. 6 is an enlarged top view of the ceiling fan of FIG. 1; and,

[56] **References Cited**

References Cited

U.S. PATENT DOCUMENTS

- D. 221,178 7/1971 Gerow D7/576
- D. 346,210 4/1994 Holbrook D23/377
- D. 363,346 10/1995 Wang D23/377

FIG. 7 is an enlarged bottom view of the ceiling fan of FIG. 1.

1 Claim, 7 Drawing Sheets

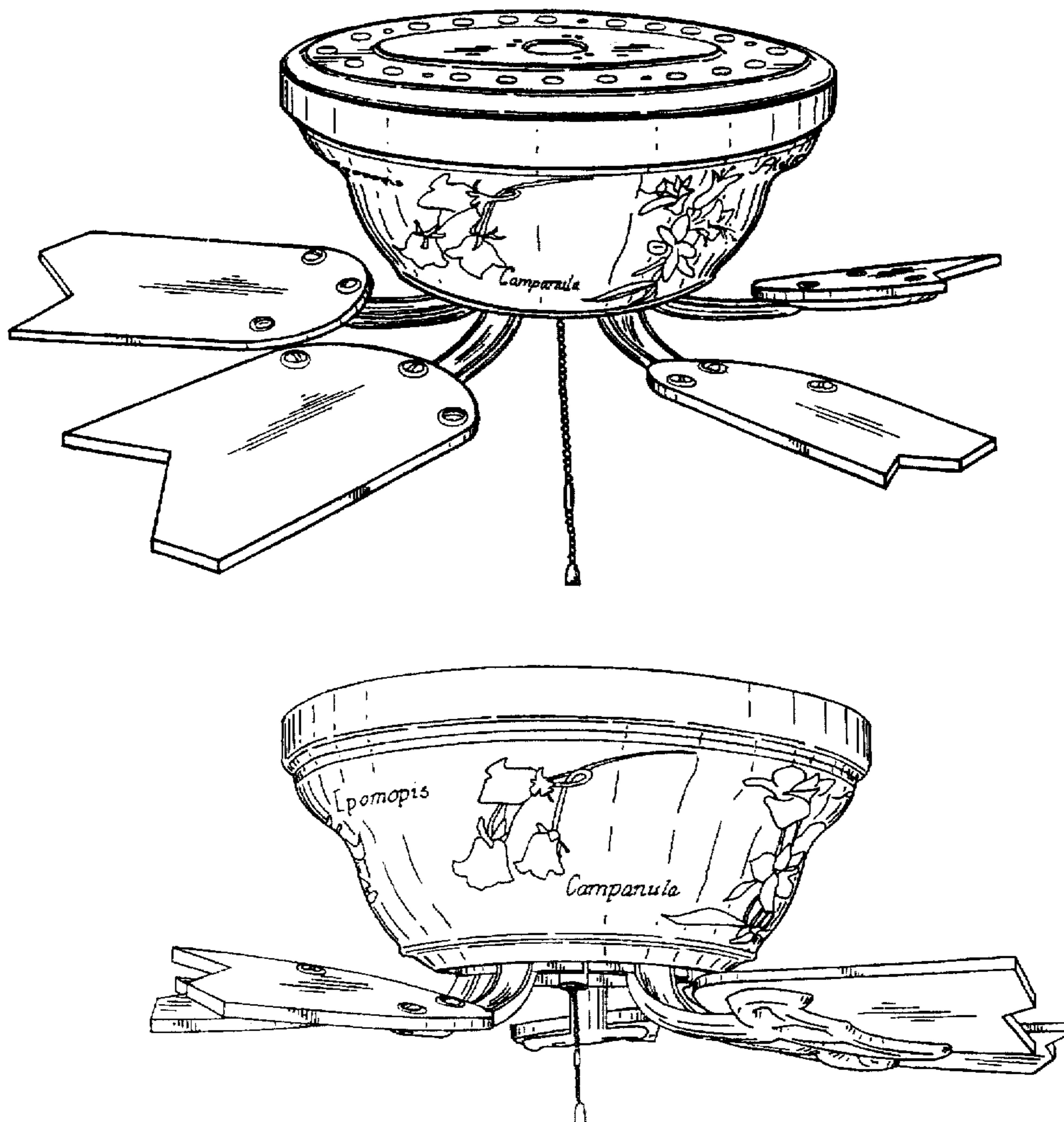

FIG. 1

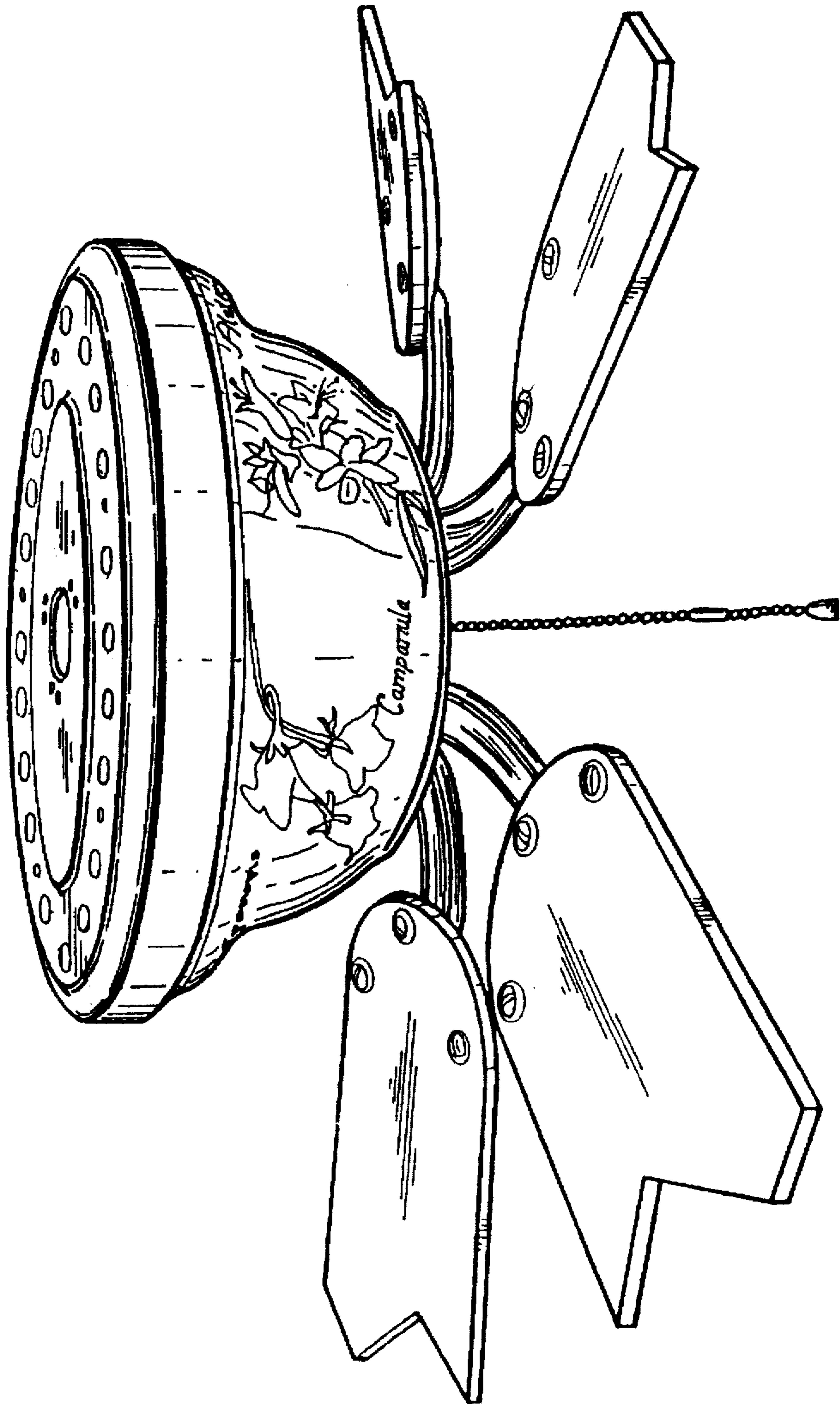

FIG. 2

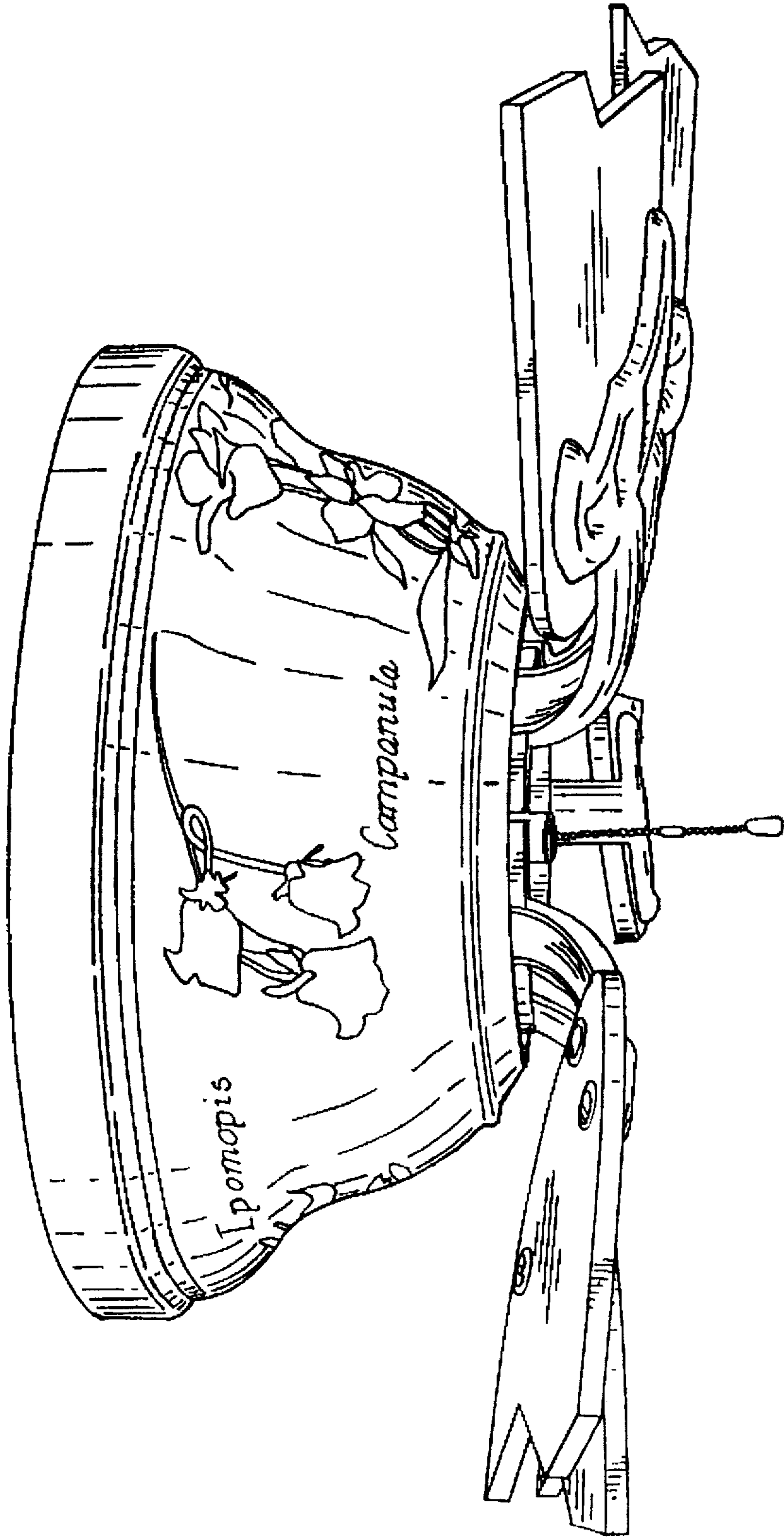

FIG. 3

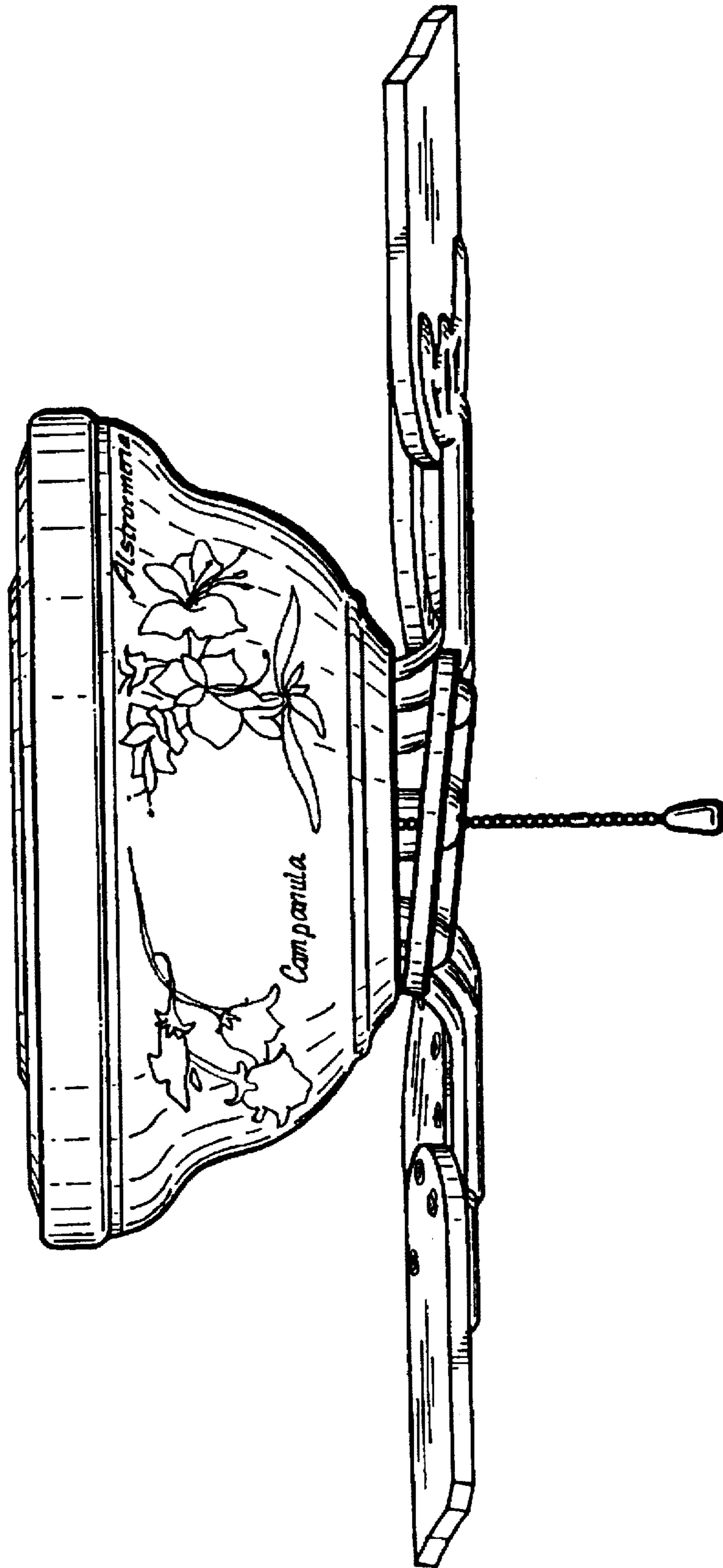

FIG. 4

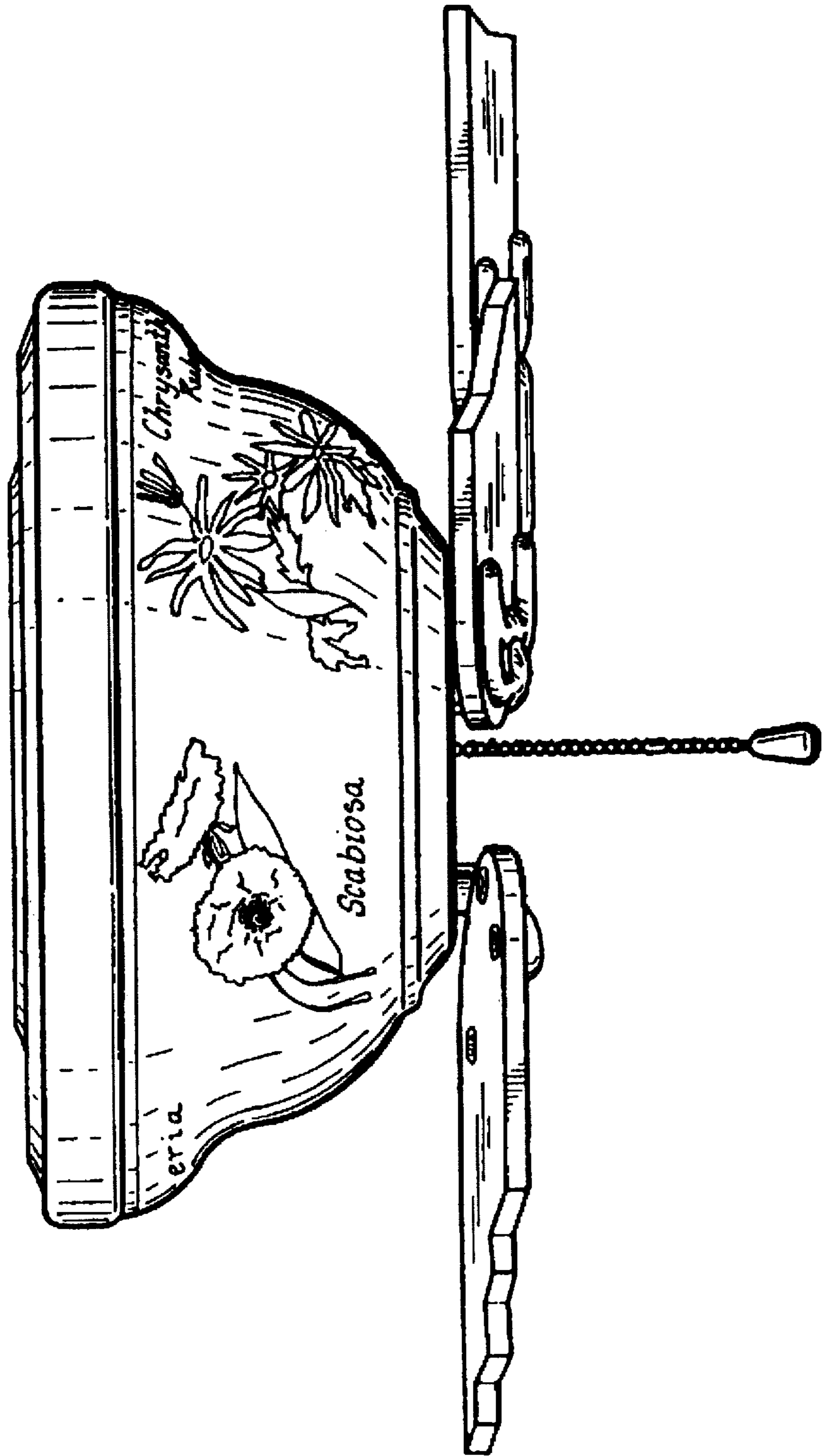

FIG. 5

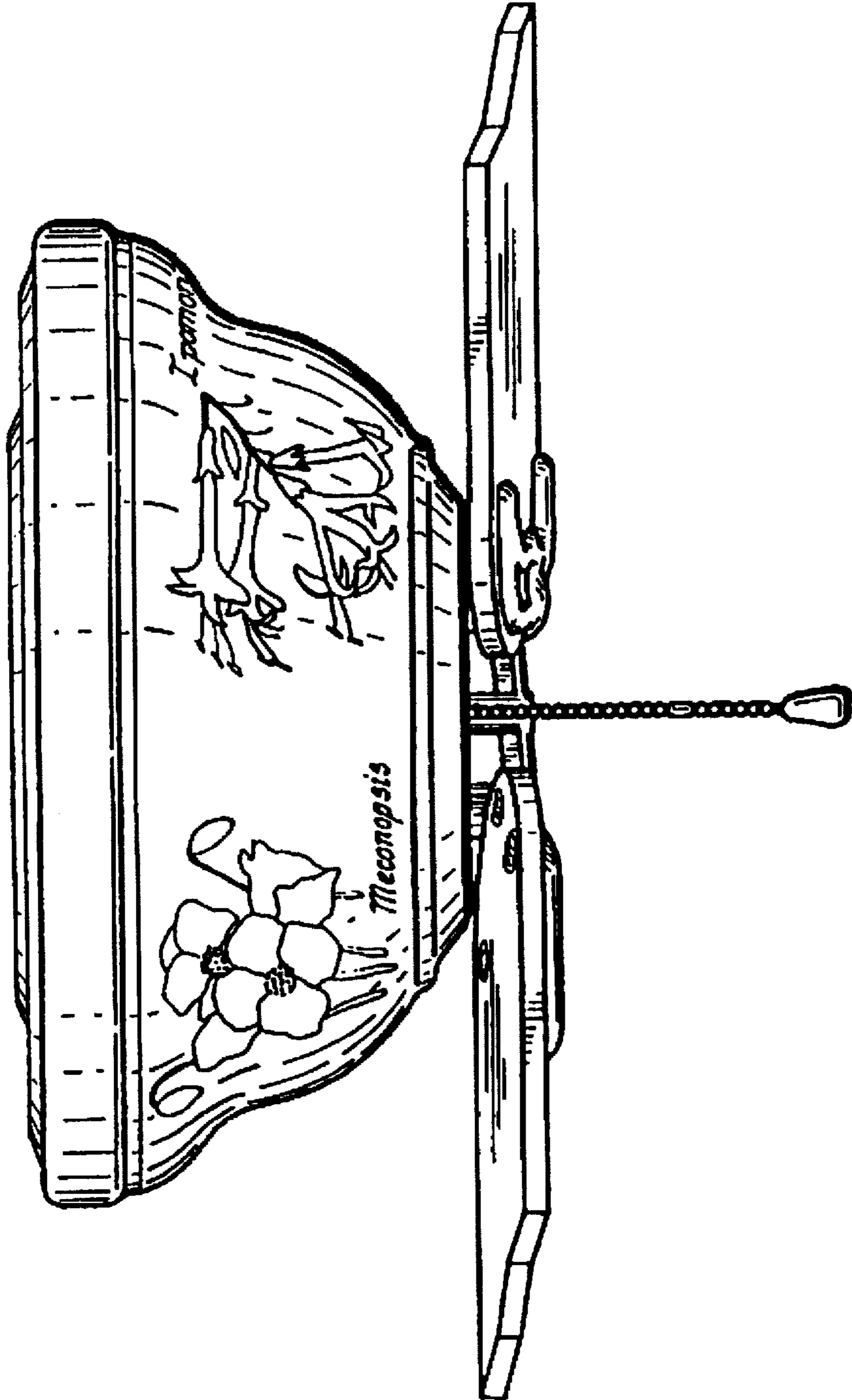

FIG. 6

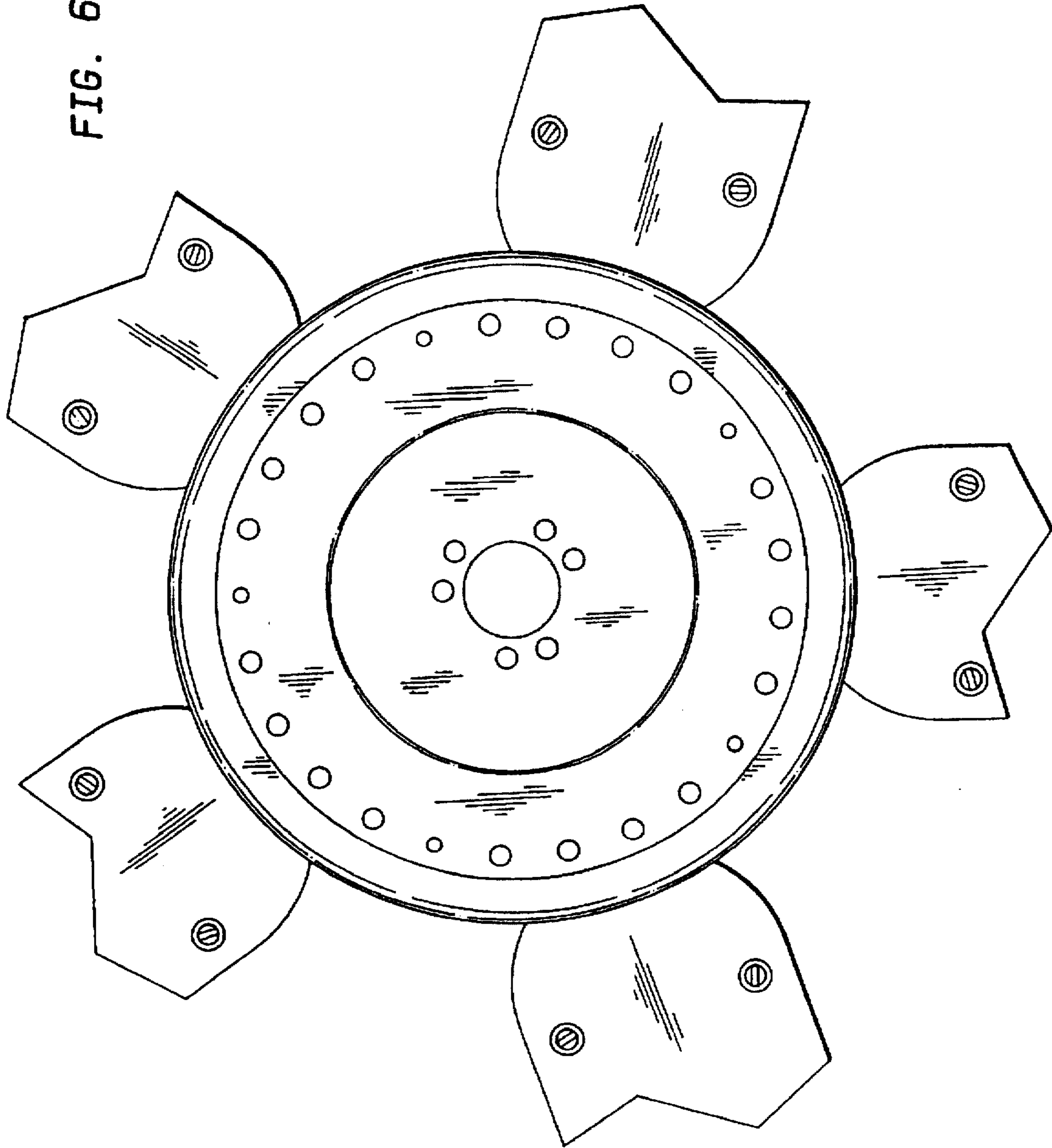

FIG. 7

