



US00D392097S

United States Patent [19]

Pottala et al.

[11] Patent Number: **Des. 392,097**

[45] Date of Patent: ****Mar. 17, 1998**

[54] **COMMUNICATION EQUIPMENT HOLDER**

[75] Inventors: **James V. Pottala**, Ft. Lauderdale;
Eduardo J. Marabotto, Miami; **Scott H. Richards**, Plantation, all of Fla.

[73] Assignee: **Motorola, Inc.**, Schaumburg, Ill.

[**] Term: **14 Years**

[21] Appl. No.: **64,278**

[22] Filed: **Dec. 26, 1996**

[51] LOC (6) Cl. **03-01**

[52] U.S. Cl. **D3/218**

[58] Field of Search **D3/218, 219; D14/138, D14/250, 251, 253; 224/240, 236, 267, 269; 379/419, 420, 455, 454**

[56] **References Cited**

U.S. PATENT DOCUMENTS

D. 261,509 10/1981 Cobb D14/253
D. 348,981 7/1994 Dill D3/218

D. 351,280 10/1994 Pennington et al. D3/218
D. 367,065 2/1996 Wu D14/253
D. 369,359 4/1996 Wright et al. D3/218 X
D. 369,465 5/1996 Scheid et al. D3/218

Primary Examiner—Louis S. Zarfes
Assistant Examiner—Catherine R. Oliver
Attorney, Agent, or Firm—M. Mansour Ghomeshi

[57] **CLAIM**

The ornamental design for a communication equipment holder, as shown and described.

DESCRIPTION

FIG. 1 is a front elevational view of the communication equipment holder showing our new design; FIG. 2 is a rear elevational view thereof; FIG. 3 is a left side elevational view thereof; FIG. 4 is a right elevational view thereof; FIG. 5 is a top plan view thereof; FIG. 6 is a bottom plan view thereof; and, FIG. 7 is a top, right, and front perspective view.

1 Claim, 4 Drawing Sheets

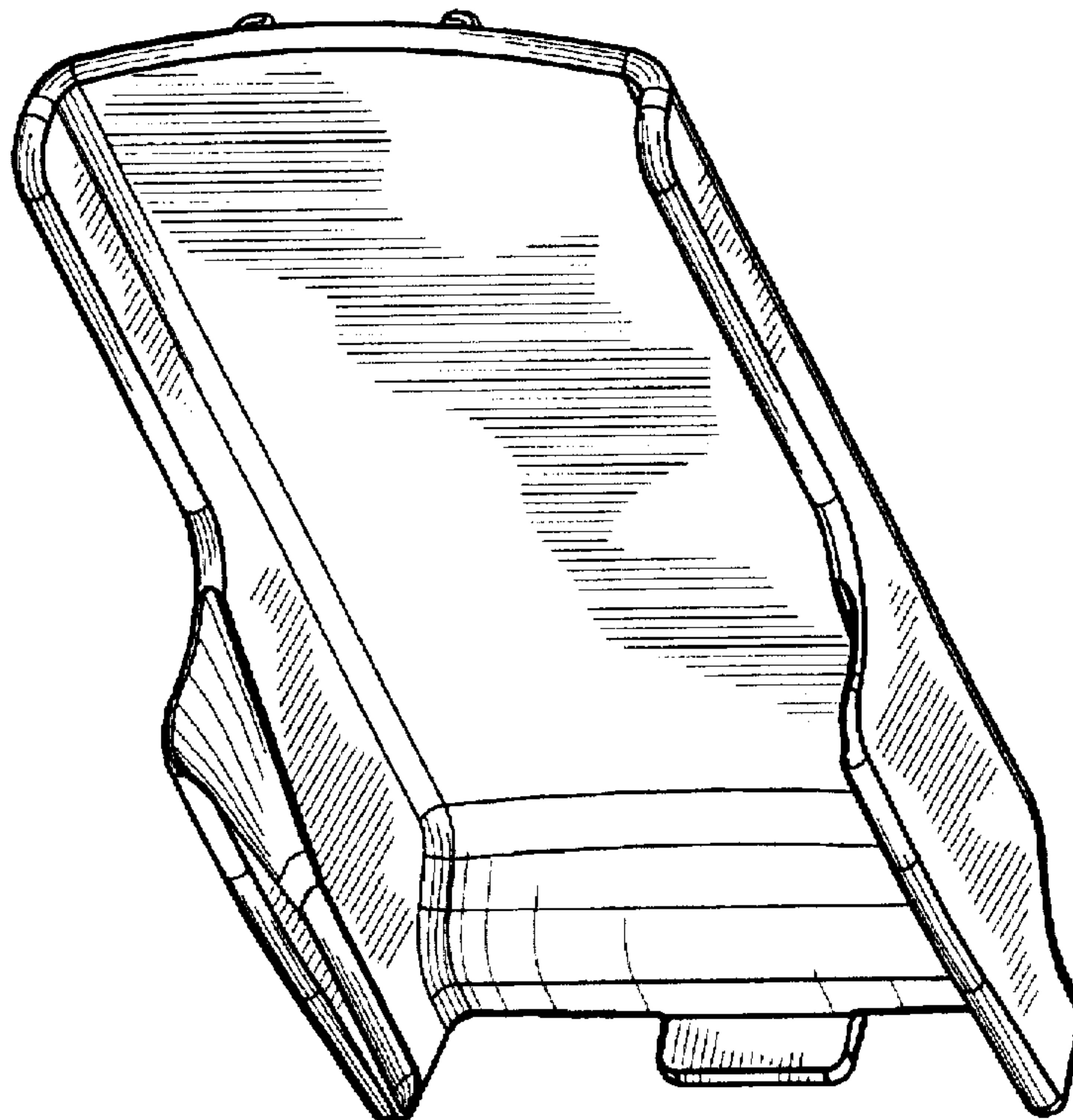

FIG. 2

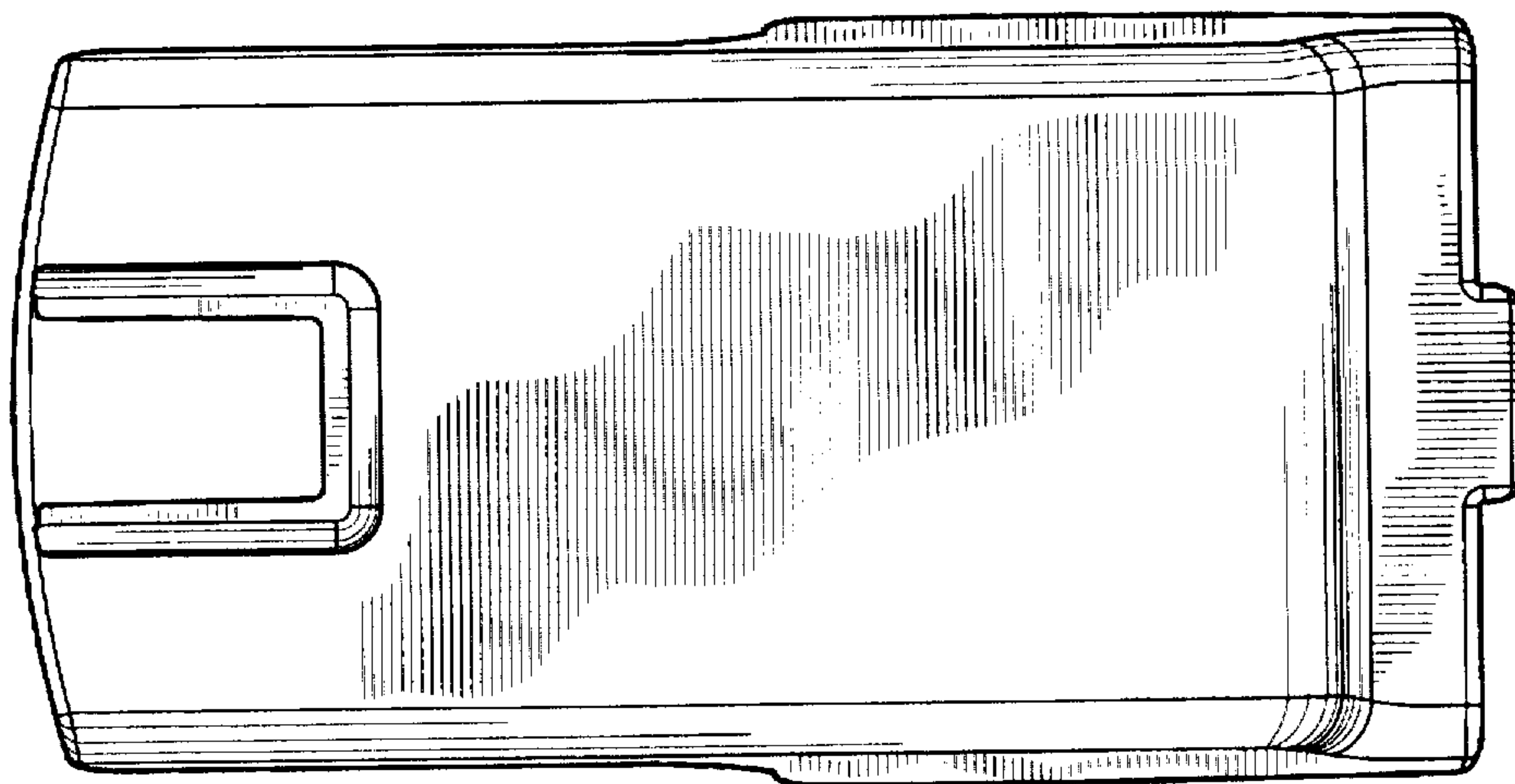

FIG. 1

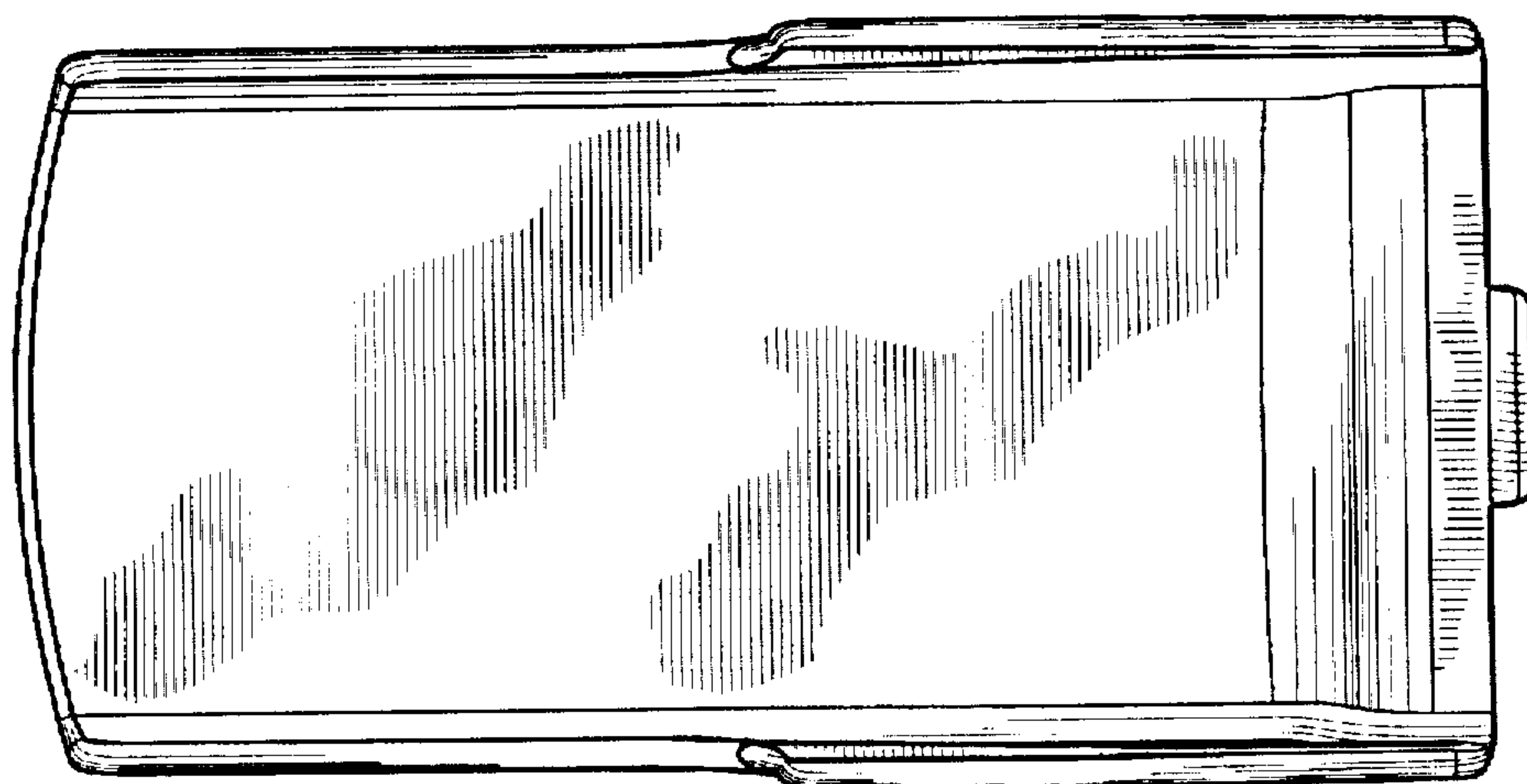

FIG. 4

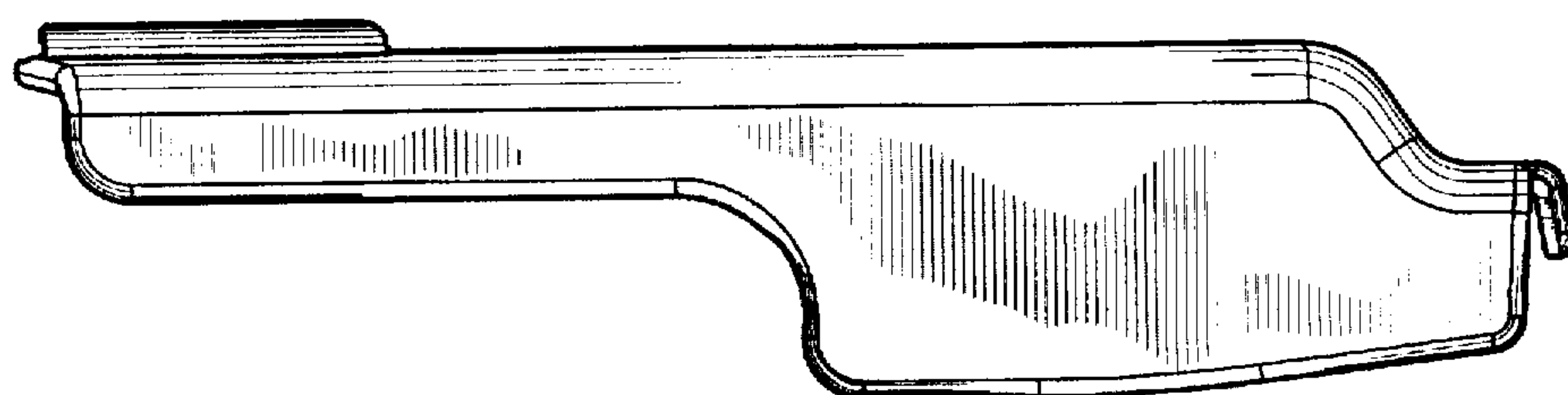

FIG. 3

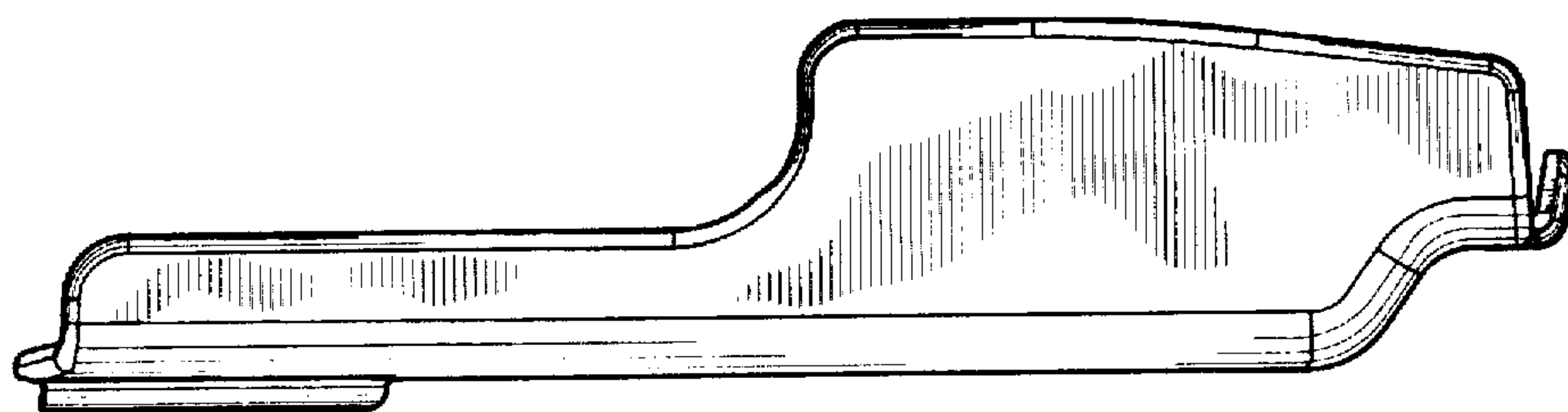

FIG. 6

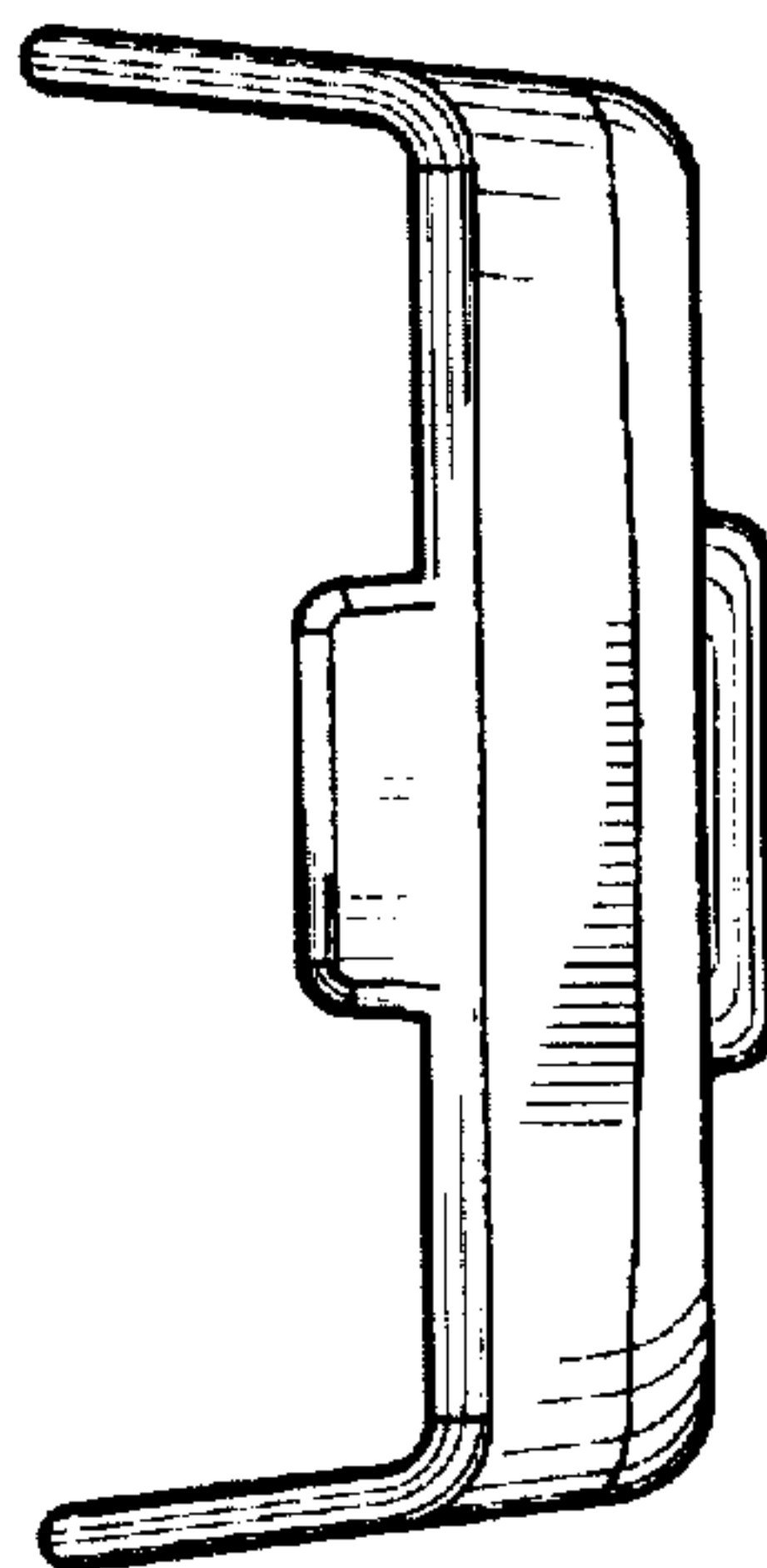

FIG. 5

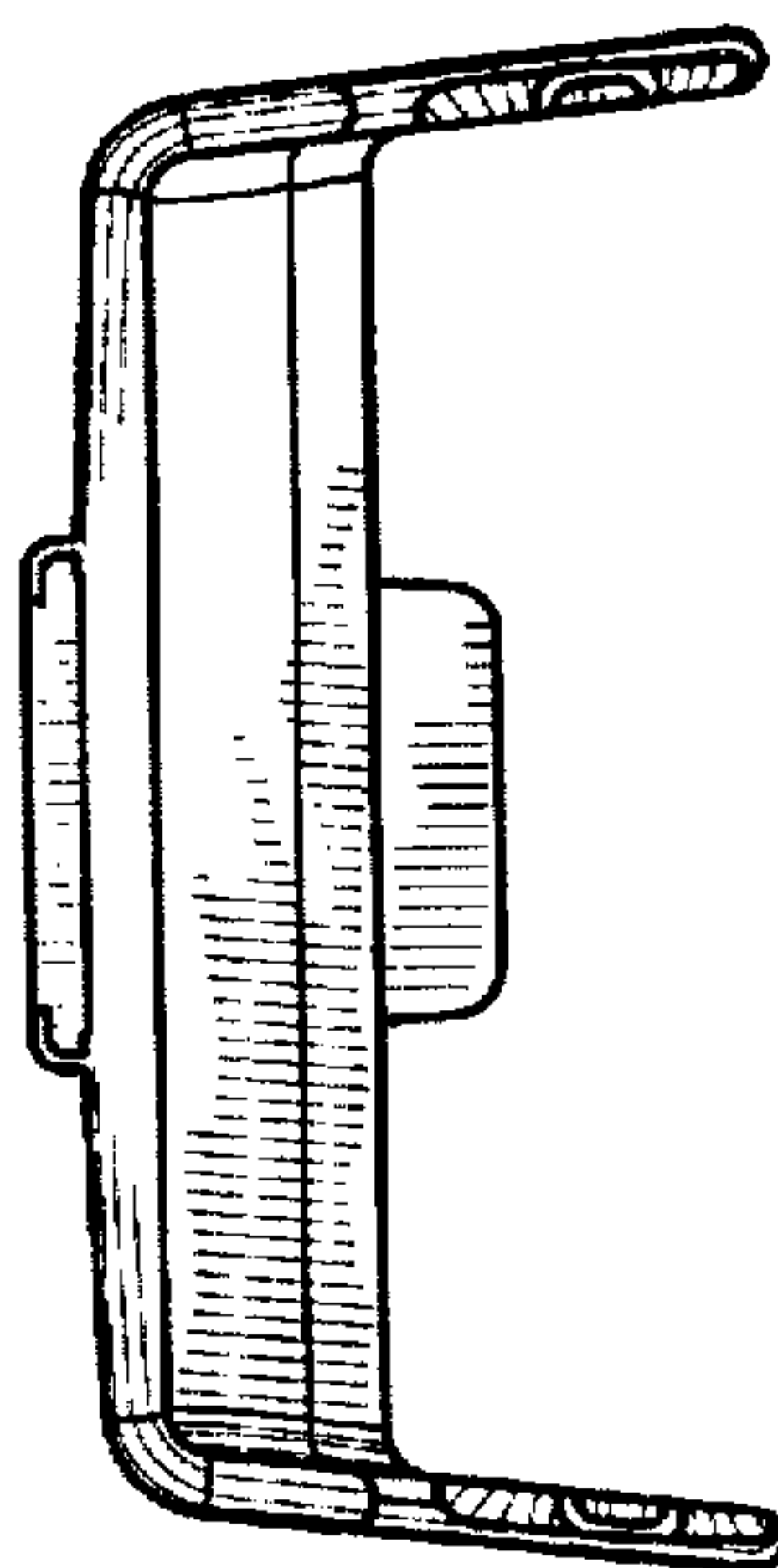

FIG. 7

