



US00D392095S

United States Patent [19]

Myers et al.

[11] Patent Number: **Des. 392,095**

[45] Date of Patent: ****Mar. 17, 1998**

[54] **BOTTLE BAG**

4,197,890 4/1980 Simko D3/202 X
4,974,761 12/1990 Luque 224/148.6

[76] Inventors: **D. Lee Myers**, 2120 Larkin St., #202,
San Francisco, Calif. 94109; **Erika Meyerovich**, 942 W. California St., Mill
Valley, Calif. 94941

Primary Examiner—Doris V. Coles
Assistant Examiner—Catherine R. Oliver
Attorney, Agent, or Firm—Ray K. Shahani

[**] Term: **14 Years**

[57] **CLAIM**

The ornamental design for a bottle bag, as shown.

[21] Appl. No.: **56,016**

DESCRIPTION

[22] Filed: **Jun. 19, 1996**

[51] **LOC (6) Cl.** **03-01**

[52] **U.S. Cl.** **D3/229**

[58] **Field of Search** D3/202, 229; D7/605,
D7/606, 607, 608, 619, 620, 623; 224/148.1,
148.3, 148.4, 148.5, 148.6

FIG. 1 is a front perspective view;
FIG. 2 is a rear perspective view;
FIG. 3 is a top perspective view;
FIG. 4 is a left perspective view;
FIG. 5 is a right perspective view;
FIG. 6 is a bottom perspective view;
FIG. 7 is a front perspective view; and,
FIG. 8 is a perspective view of the bottle bag shown in use.
It will be understood that the broken line environment of
FIGS. 1-8 is for illustrative purposes only and form no part
of the claimed design.

[56] **References Cited**

U.S. PATENT DOCUMENTS

D. 315,058 3/1991 Burke D3/202 X
D. 374,975 10/1996 Vargas et al. D3/202
2,464,069 3/1949 Benson D3/202 X

1 Claim, 3 Drawing Sheets

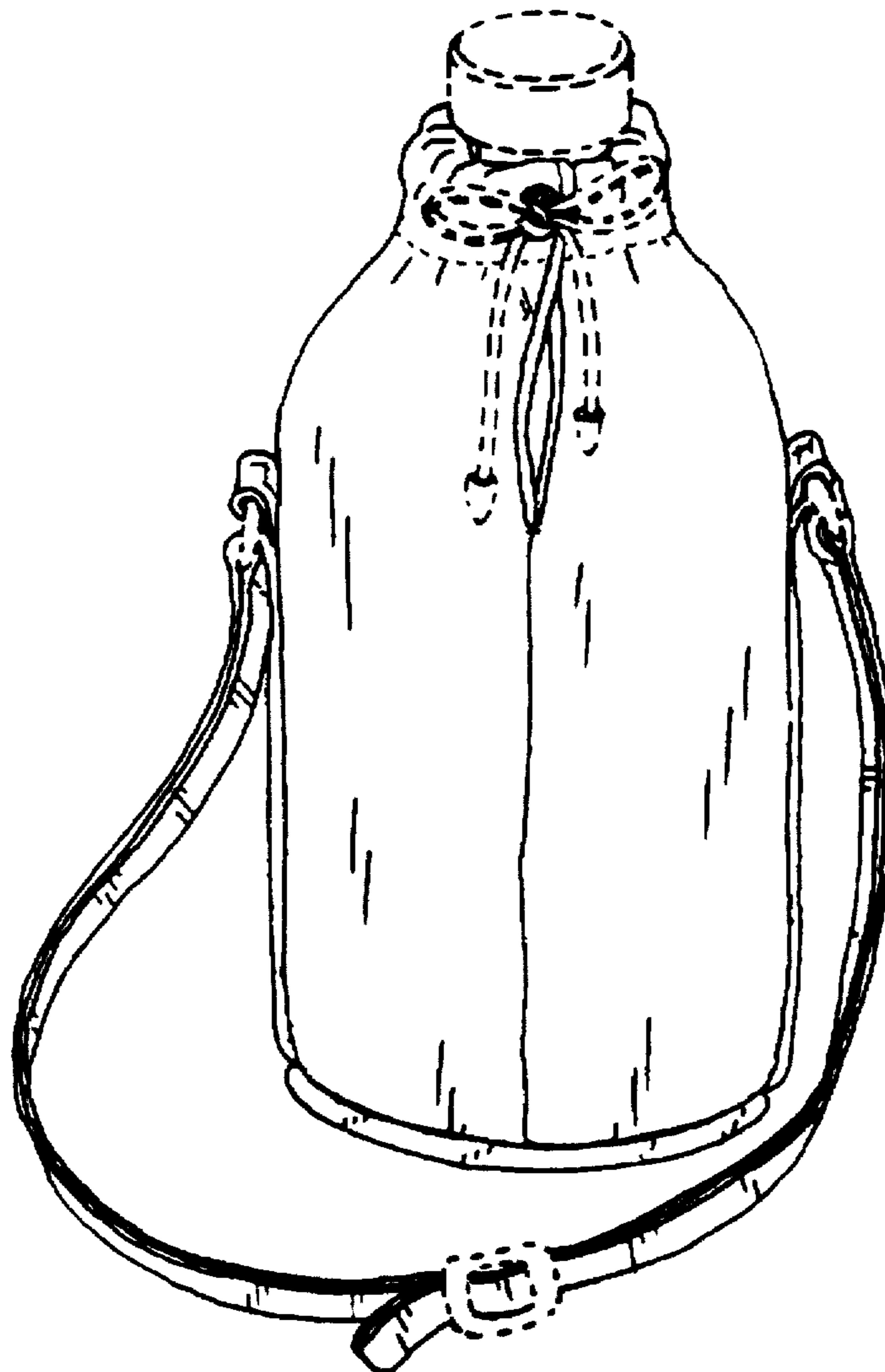

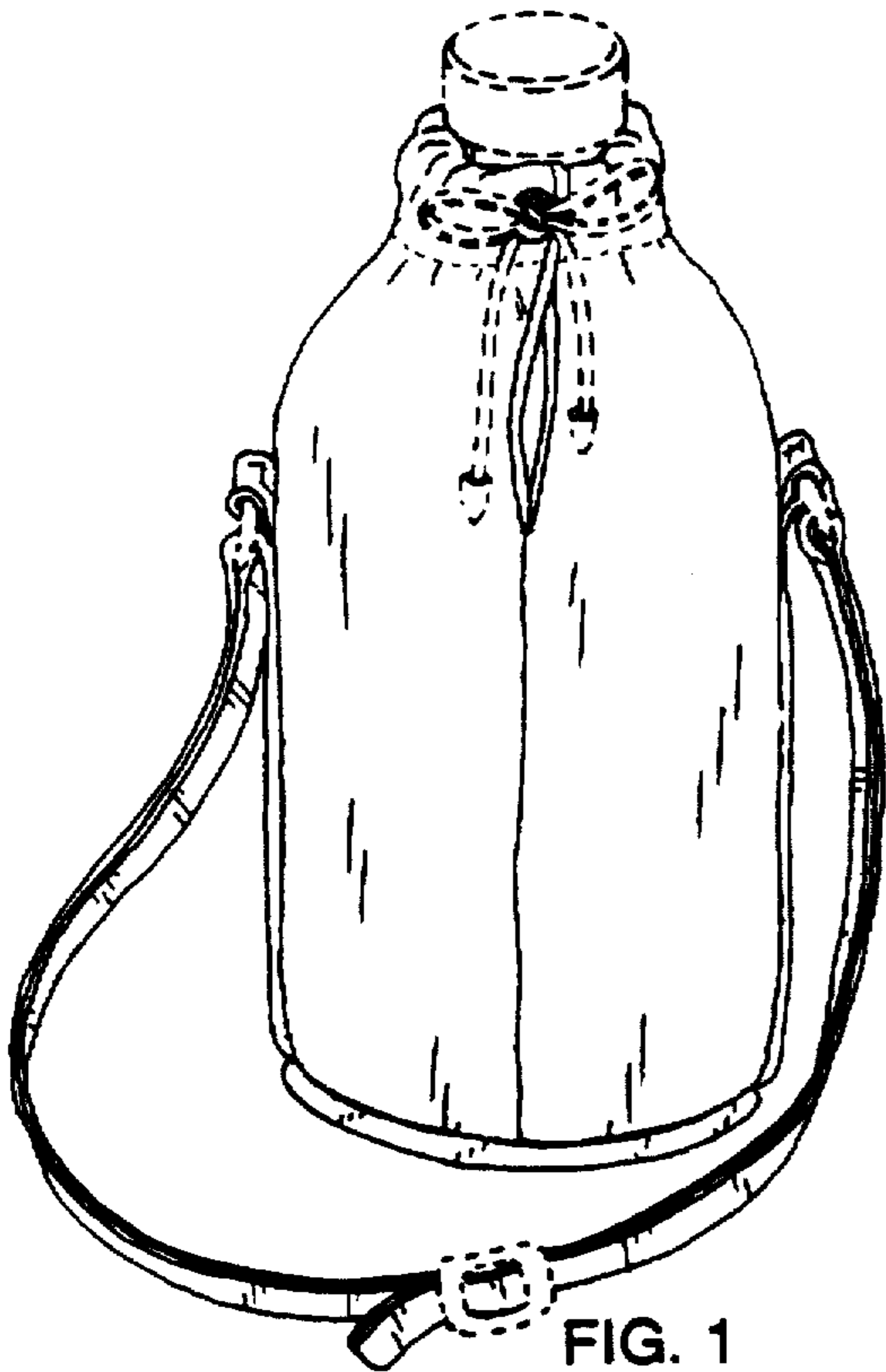

FIG. 1

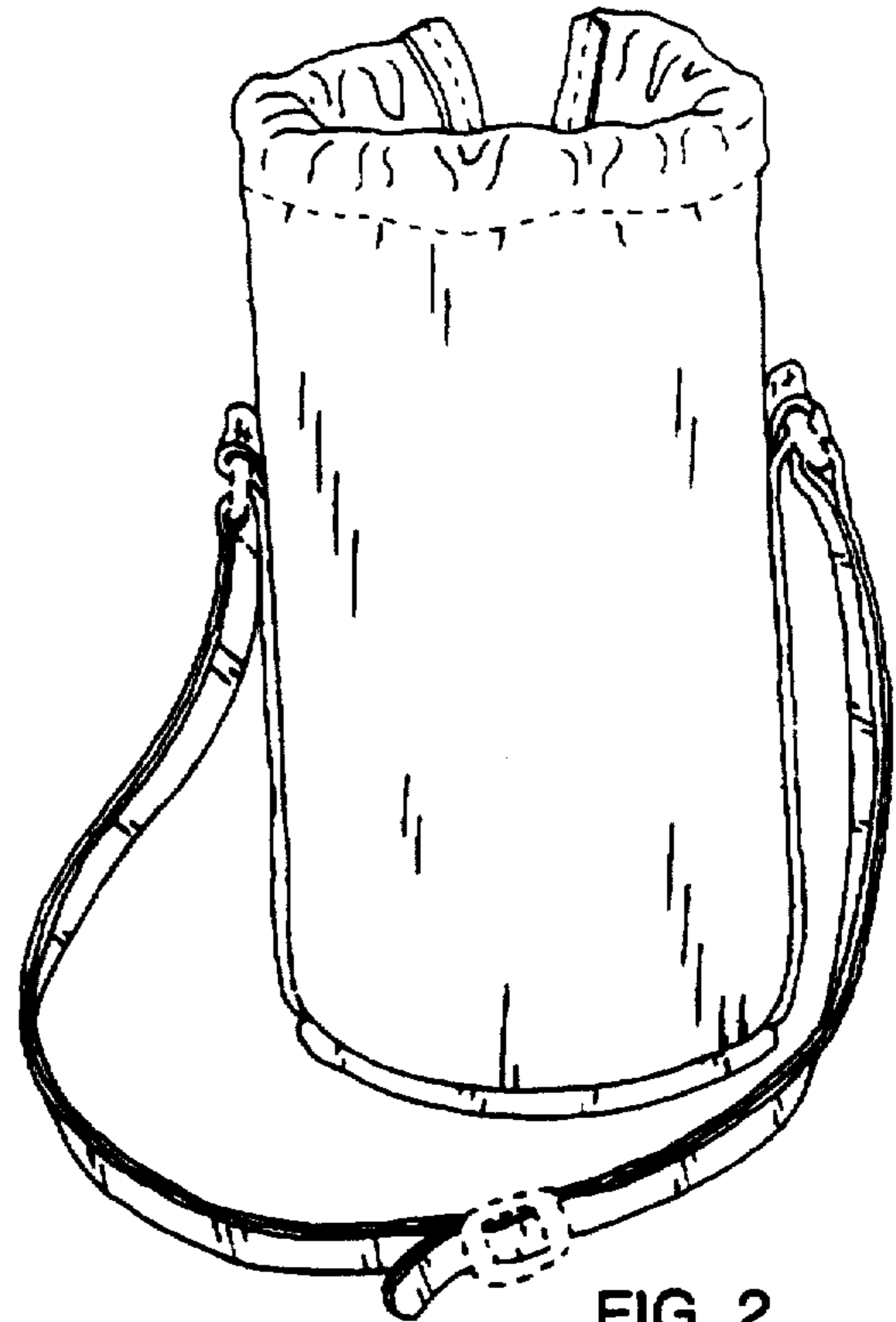

FIG. 2

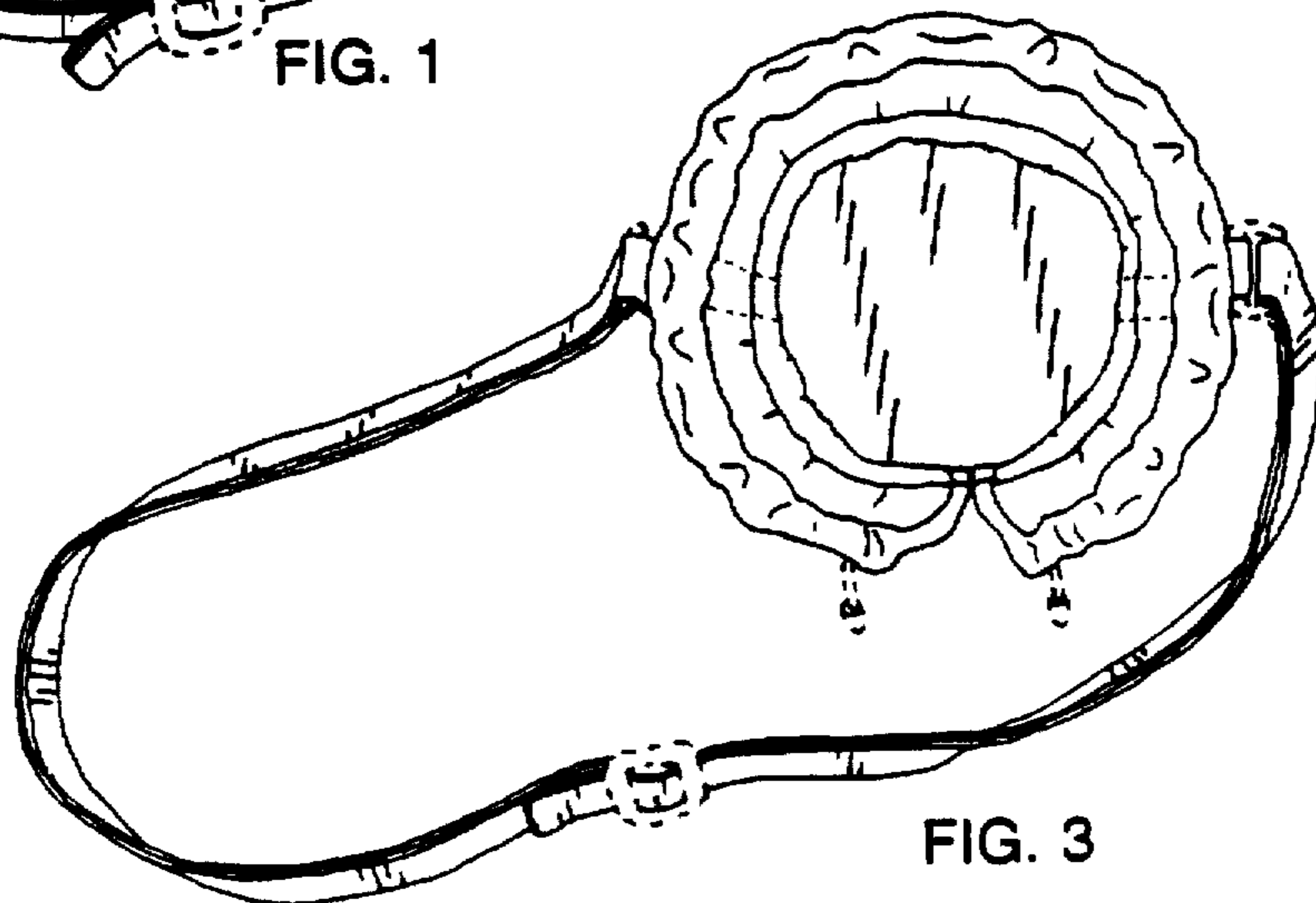

FIG. 3

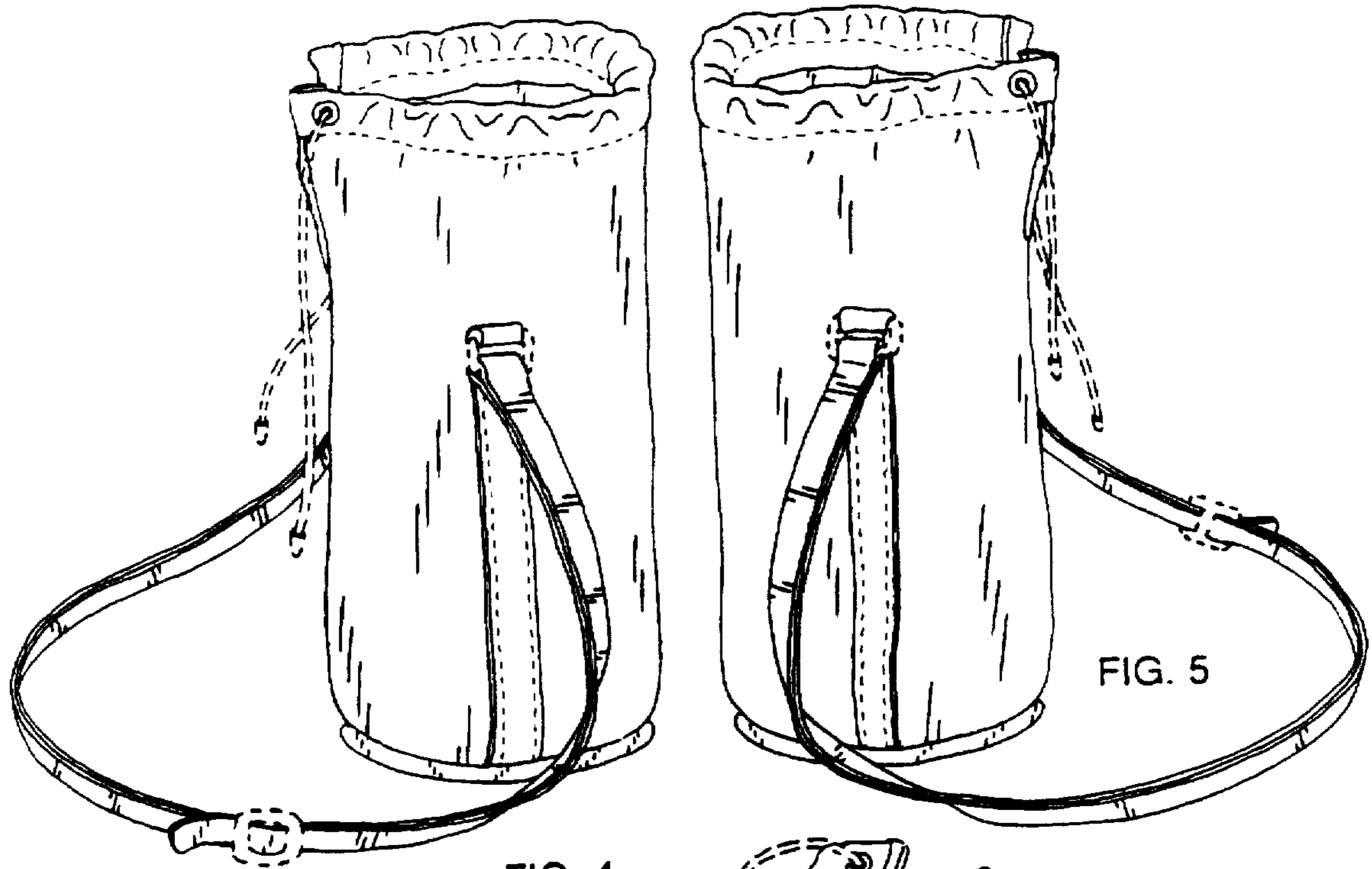

FIG. 4

FIG. 5

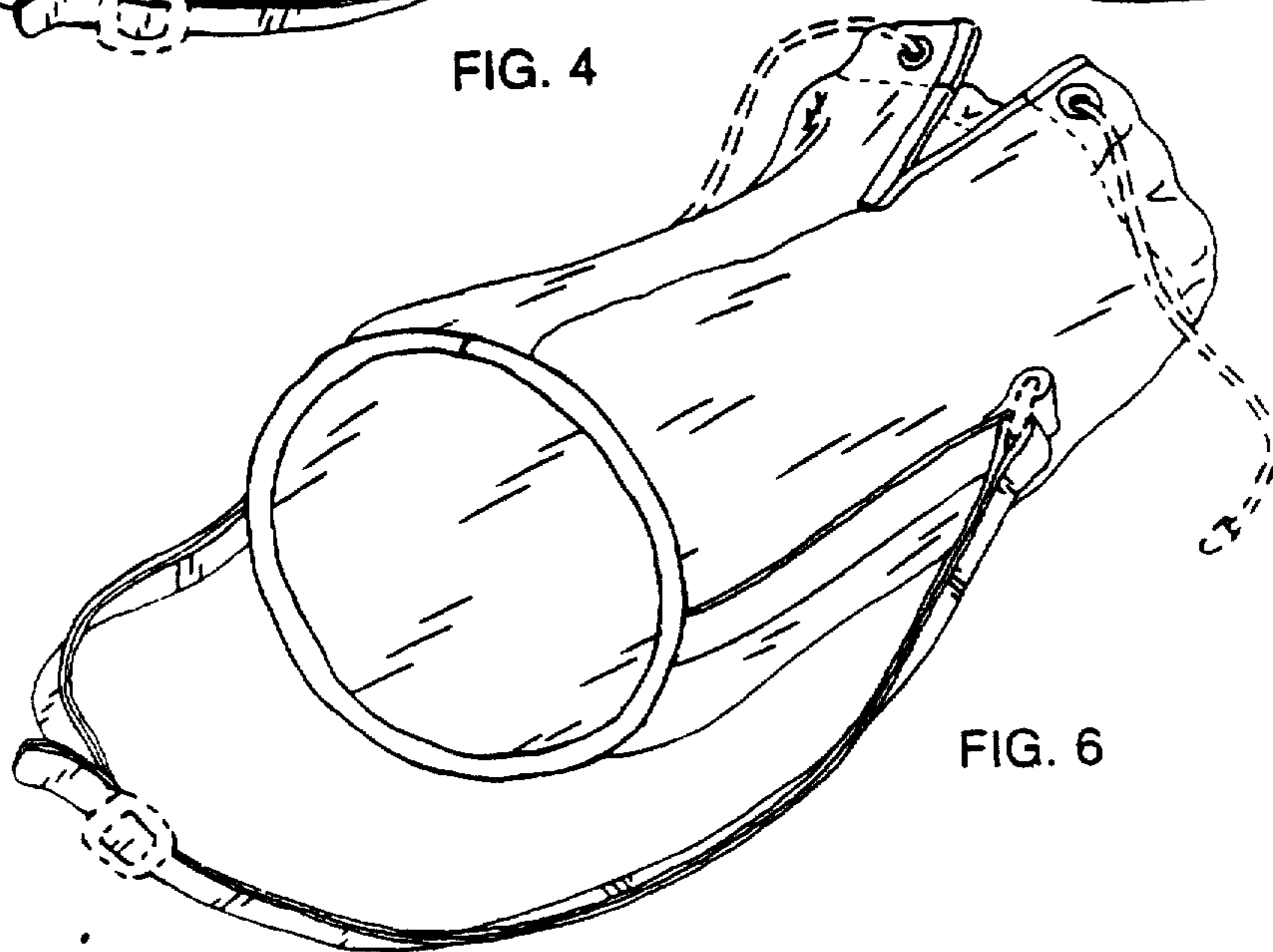

FIG. 6

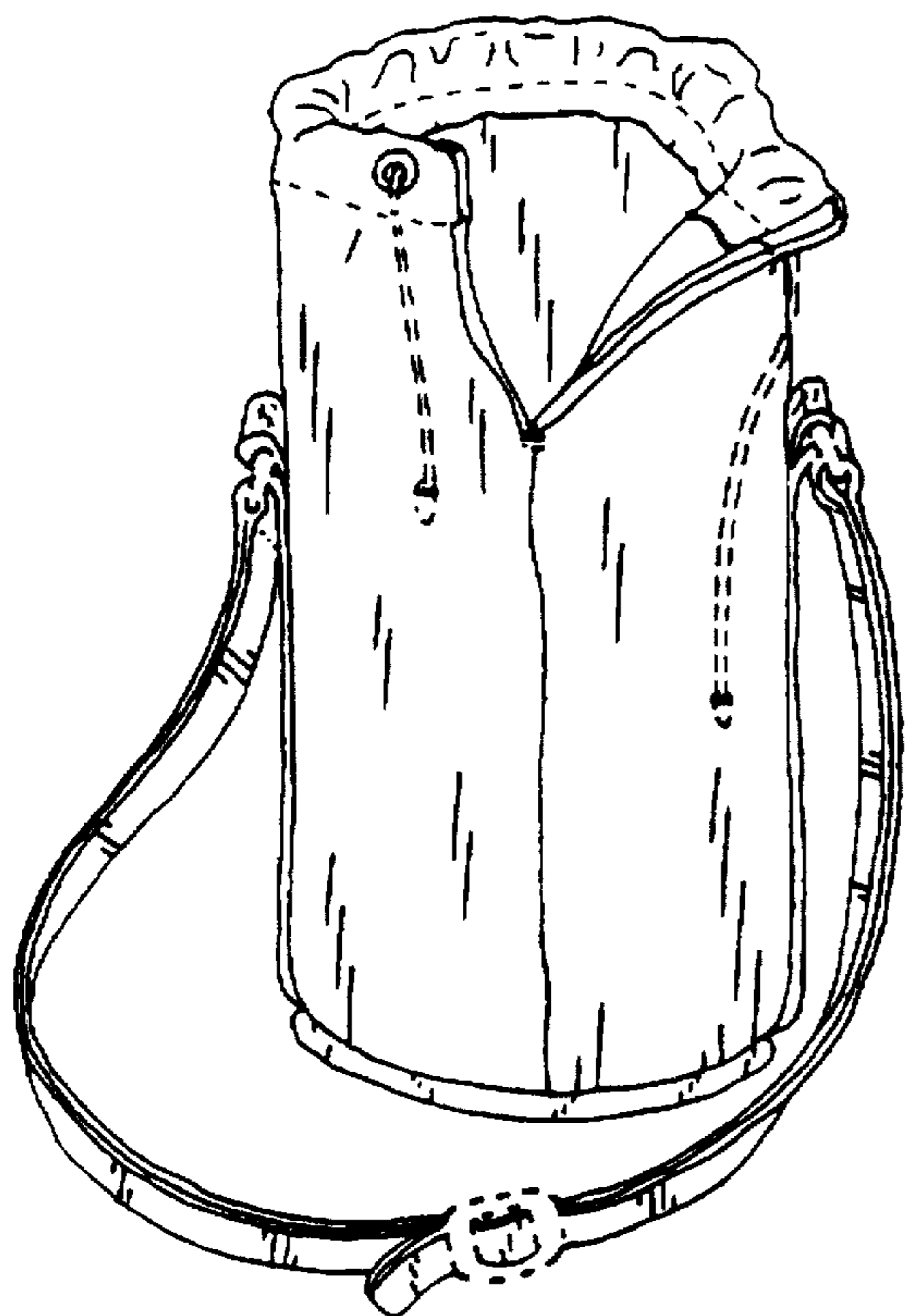

FIG. 7

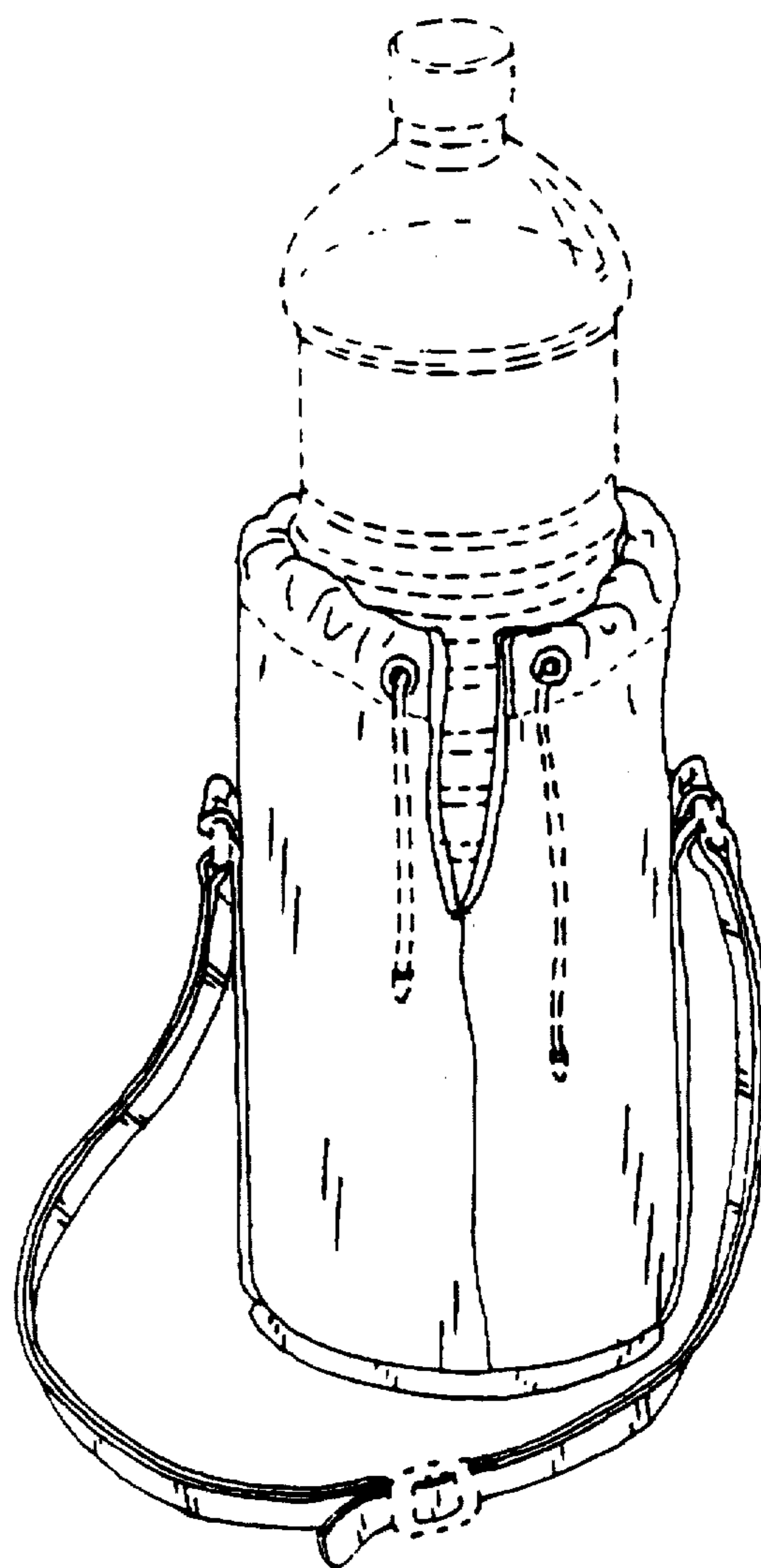

FIG. 8