



US00D392079S

United States Patent [19]

[11] Patent Number: Des. 392,079

Omerza

[45] Date of Patent: **Mar. 10, 1998

[54] **HAND HELD BUFFER FOR BUFFING ROUND ARTICLES**

[76] Inventor: **Daniel R. Omerza**, 437 Midway Island, Clearwater, Fla. 34630

[**] Term: **14 Years**

[21] Appl. No.: **73,742**

[22] Filed: **Jul. 22, 1997**

[51] LOC (6) Cl. **04-01**

[52] U.S. Cl. **D32/52; D32/40**

[58] Field of Search D32/40, 35, 43, D32/52, 51; D4/137; D28/63; 15/244.1, 244.4, 218.1, 220.4, 209.1, 210.1, 229.11, 229.12, 229.13; 401/137, 138, 139, 140, 203, 133

[56] **References Cited**

U.S. PATENT DOCUMENTS

D. 228,339	9/1973	Zemke	D32/52
D. 269,387	6/1983	McClelland	D32/52
D. 304,513	11/1989	Loffredo	D32/40
1,449,856	3/1923	Hampson	D32/52 X
1,469,404	10/1923	Bohrman	.	
1,761,109	6/1930	Dietz	.	
1,958,408	5/1934	Jelliffe et al.	15/229.1
2,551,105	5/1951	Eiden et al.	.	
2,755,494	7/1956	Bredin	.	
2,778,049	1/1957	Meyer	15/229.1
3,010,133	11/1961	Hurd	.	

Primary Examiner—Susan J. Lucas
Assistant Examiner—Cynthia F. Ramirez
Attorney, Agent, or Firm—Harold D. Shall

[57] **CLAIM**

The ornamental design for a "hand held buffer for buffing round articles", as shown.

DESCRIPTION

FIG. 1 is a perspective view of a hand held buffer for buffing round articles showing my new design; FIG. 2 is a front elevational view; FIG. 3 is a rear elevational view; FIG. 4 is a right side elevational view; FIG. 5 is a left side elevational view; FIG. 6 is a top plan view; and FIG. 7 is a bottom plan view; FIG. 8 is a perspective view of a second embodiment of my design of a hand held buffer for buffing round articles showing a second embodiment of my new design; FIG. 9 is a front elevational view of my second embodiment; FIG. 10 is a rear elevational view of my second embodiment; FIG. 11 is a right side elevational view of my second embodiment; FIG. 12 is a left side elevational view of my second embodiment; FIG. 13 is a top plan view of my second embodiment; and FIG. 14 is a bottom plan view of my second embodiment.

1 Claim, 6 Drawing Sheets

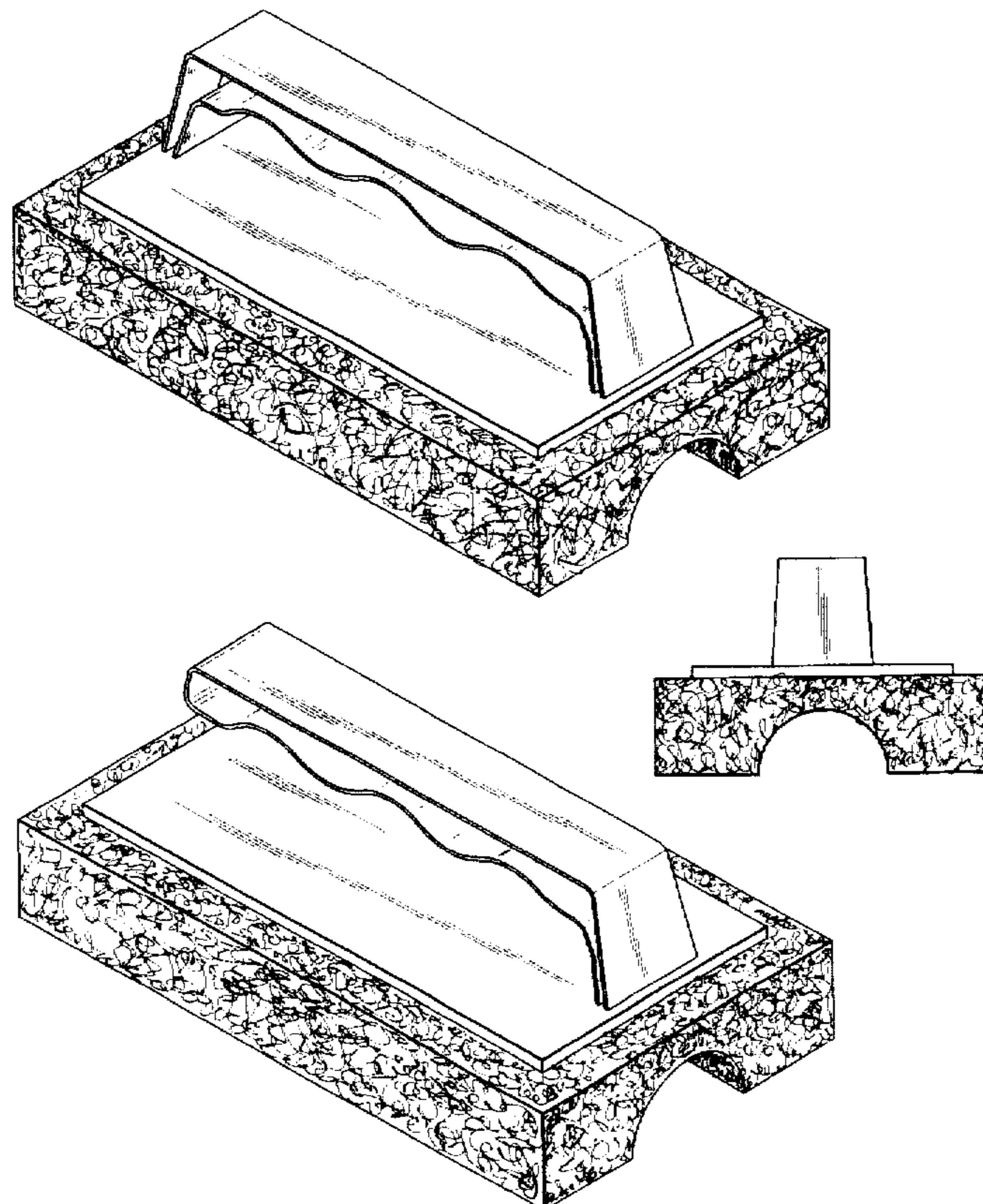

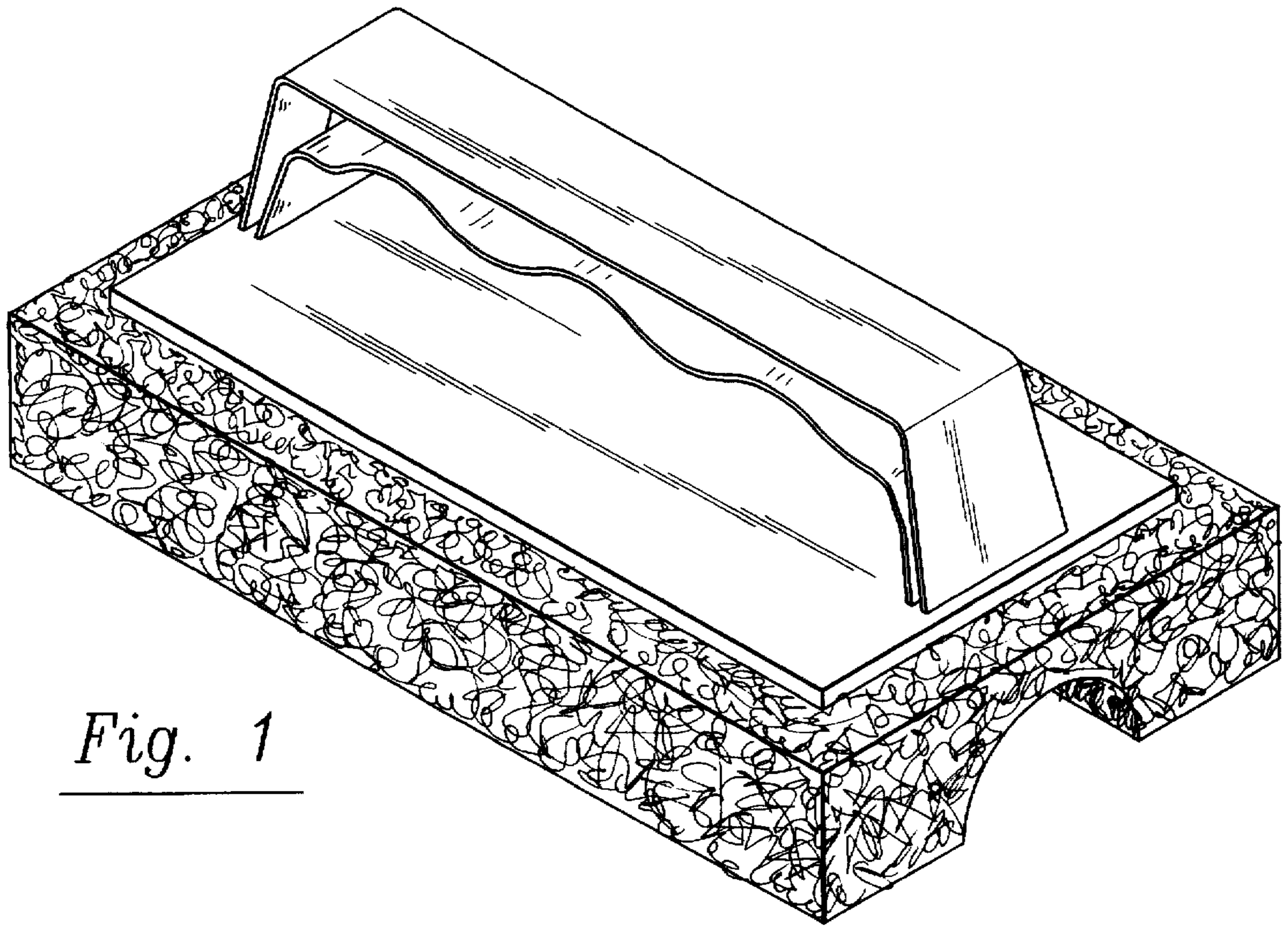

Fig. 1

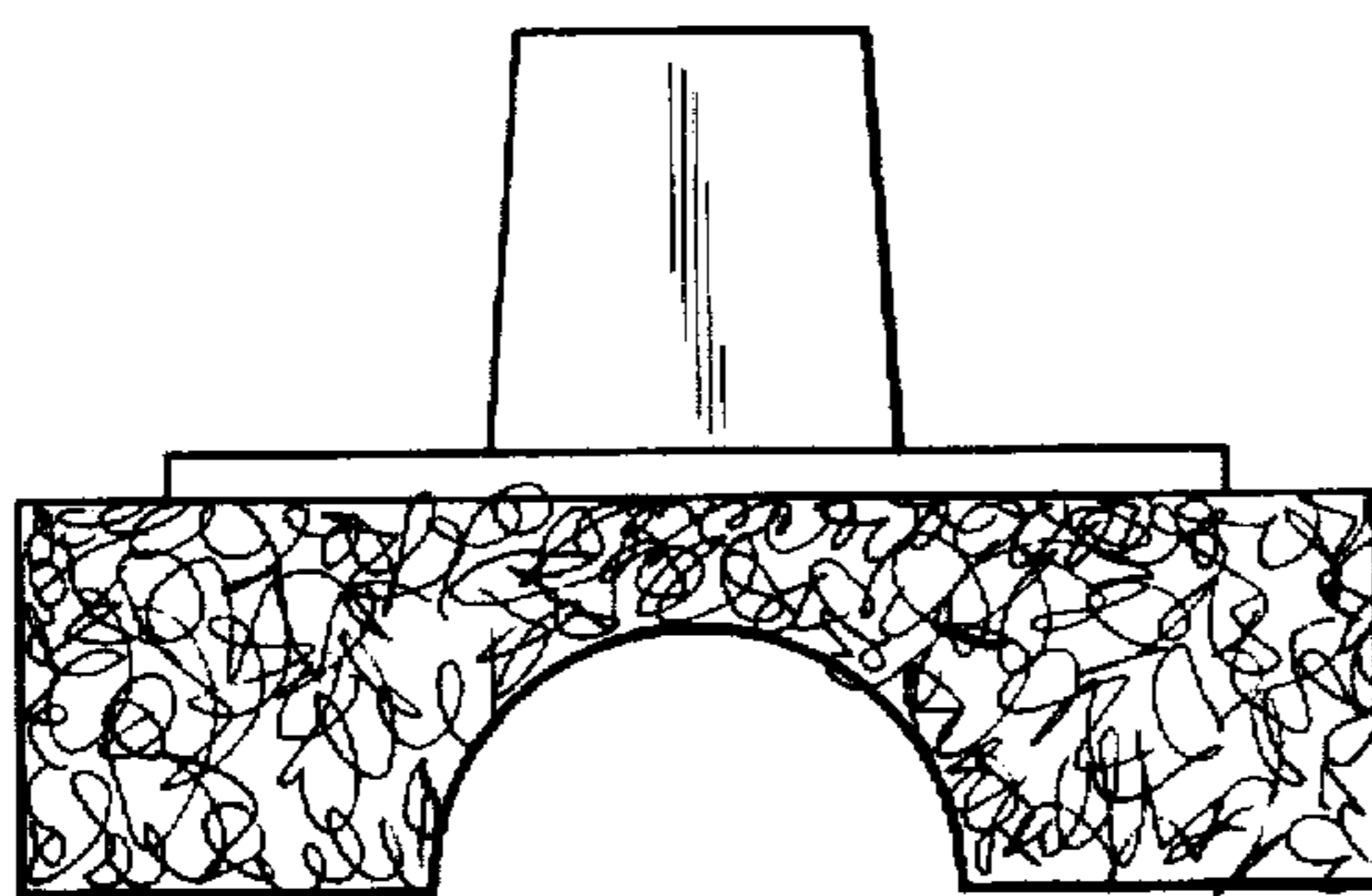

Fig. 2

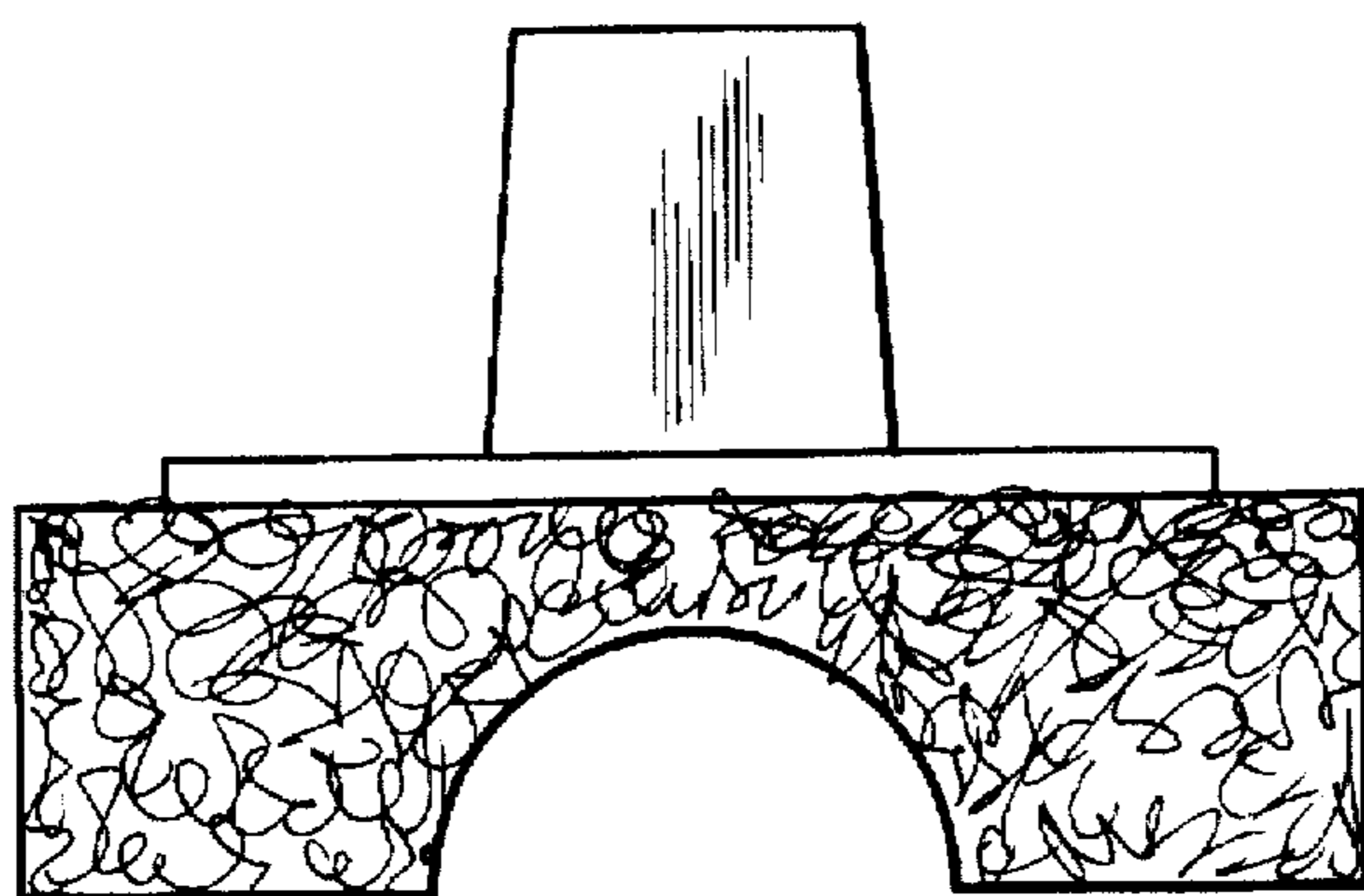

Fig. 3

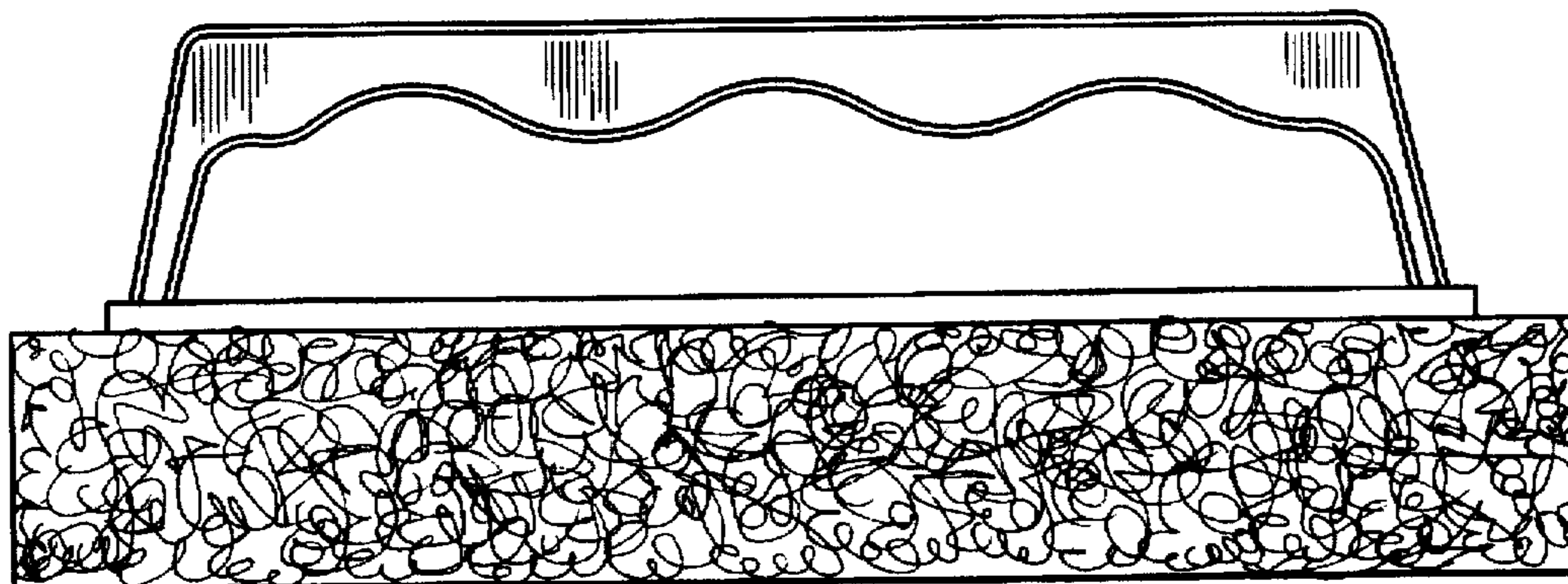

Fig. 4

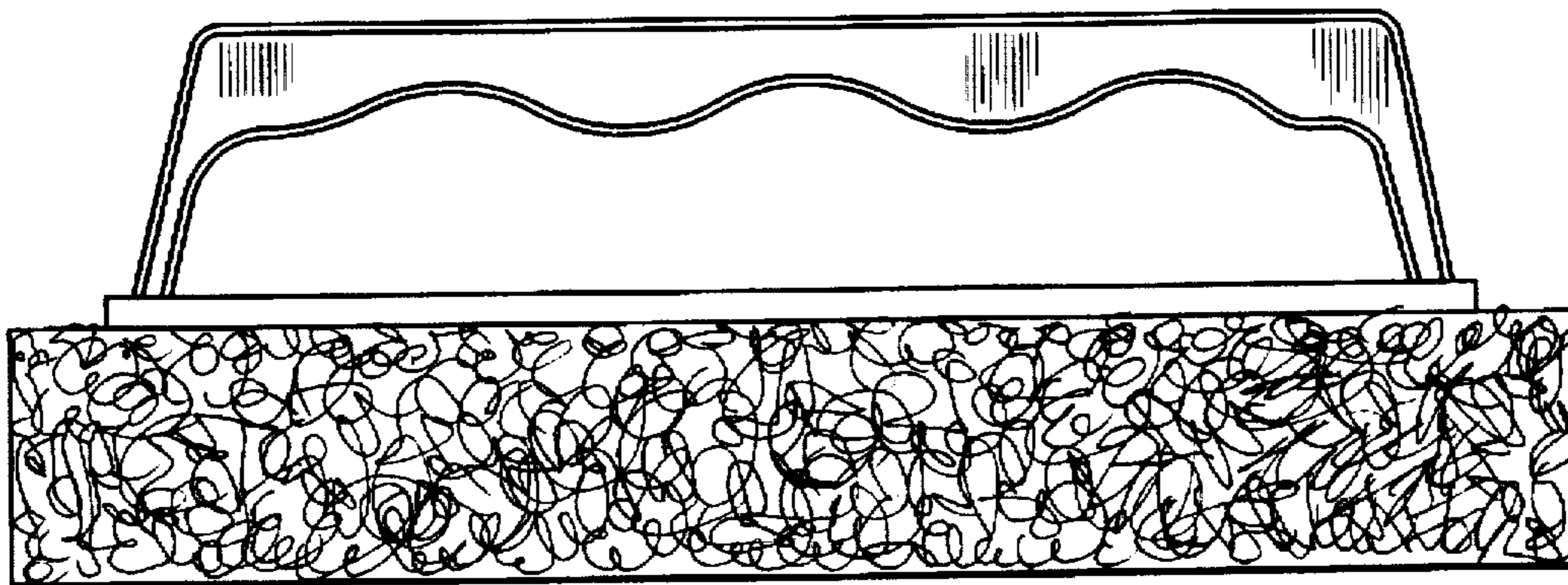

Fig. 5

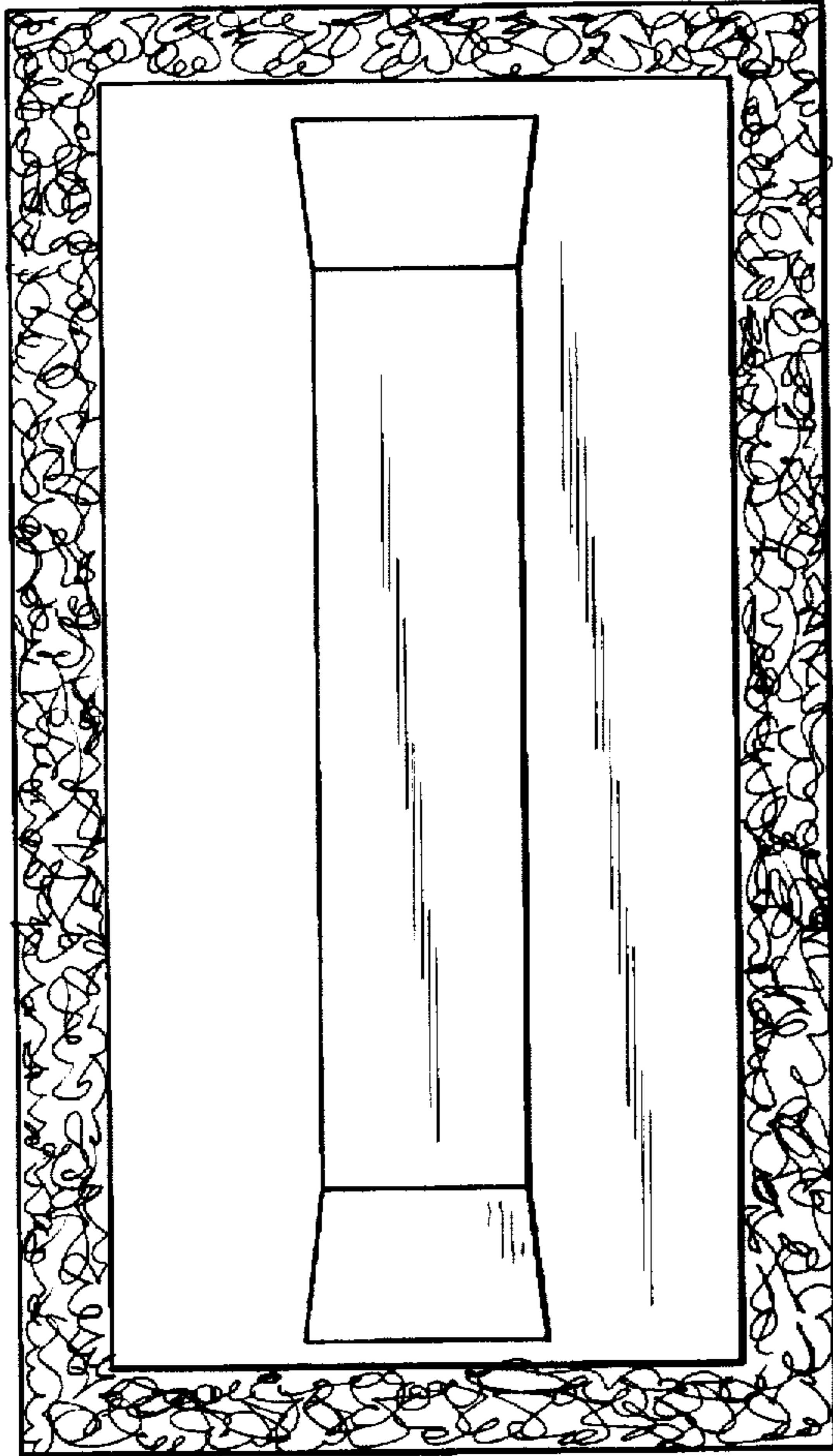

Fig. 6

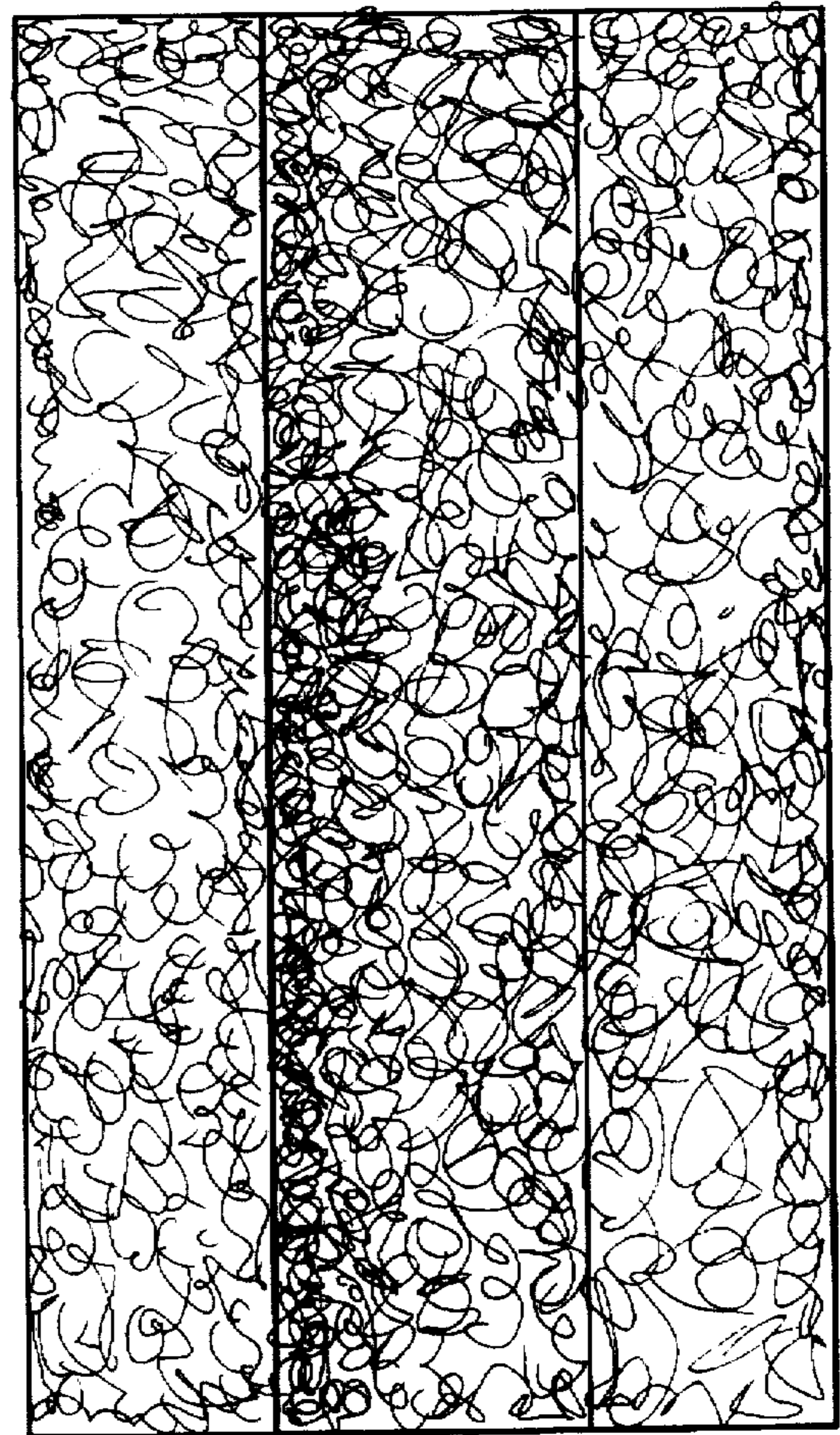

Fig. 7

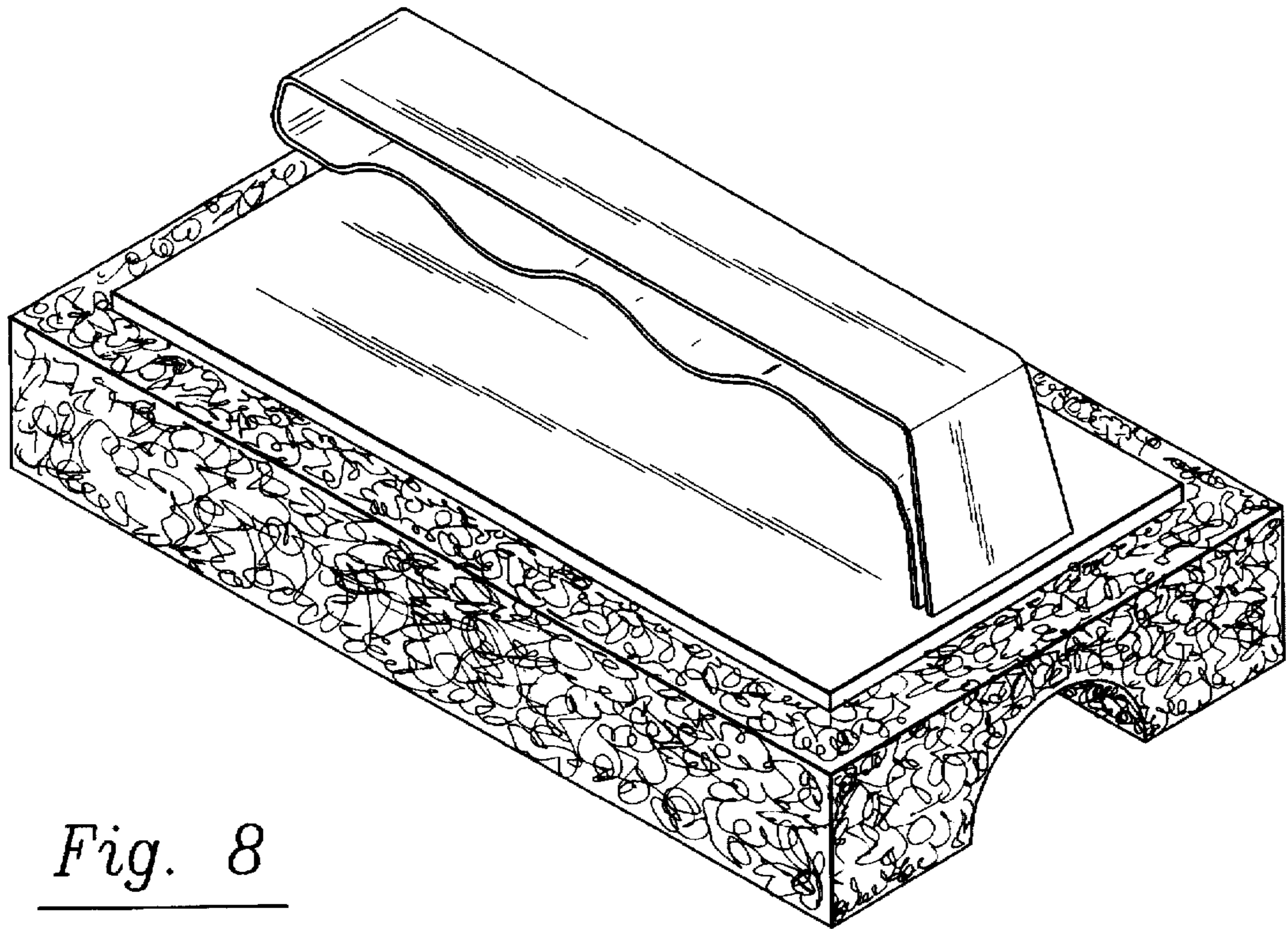

Fig. 8

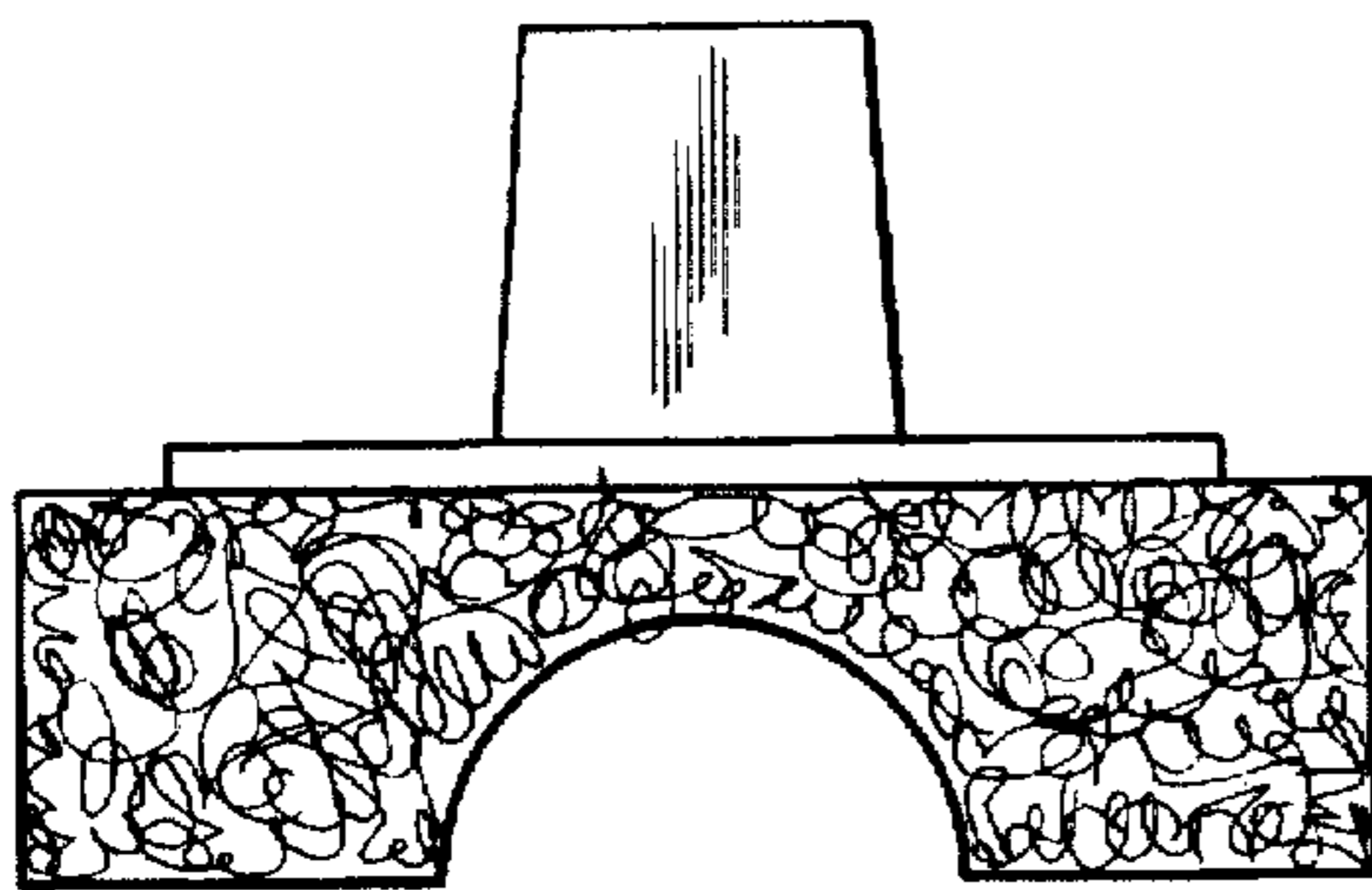

Fig. 9

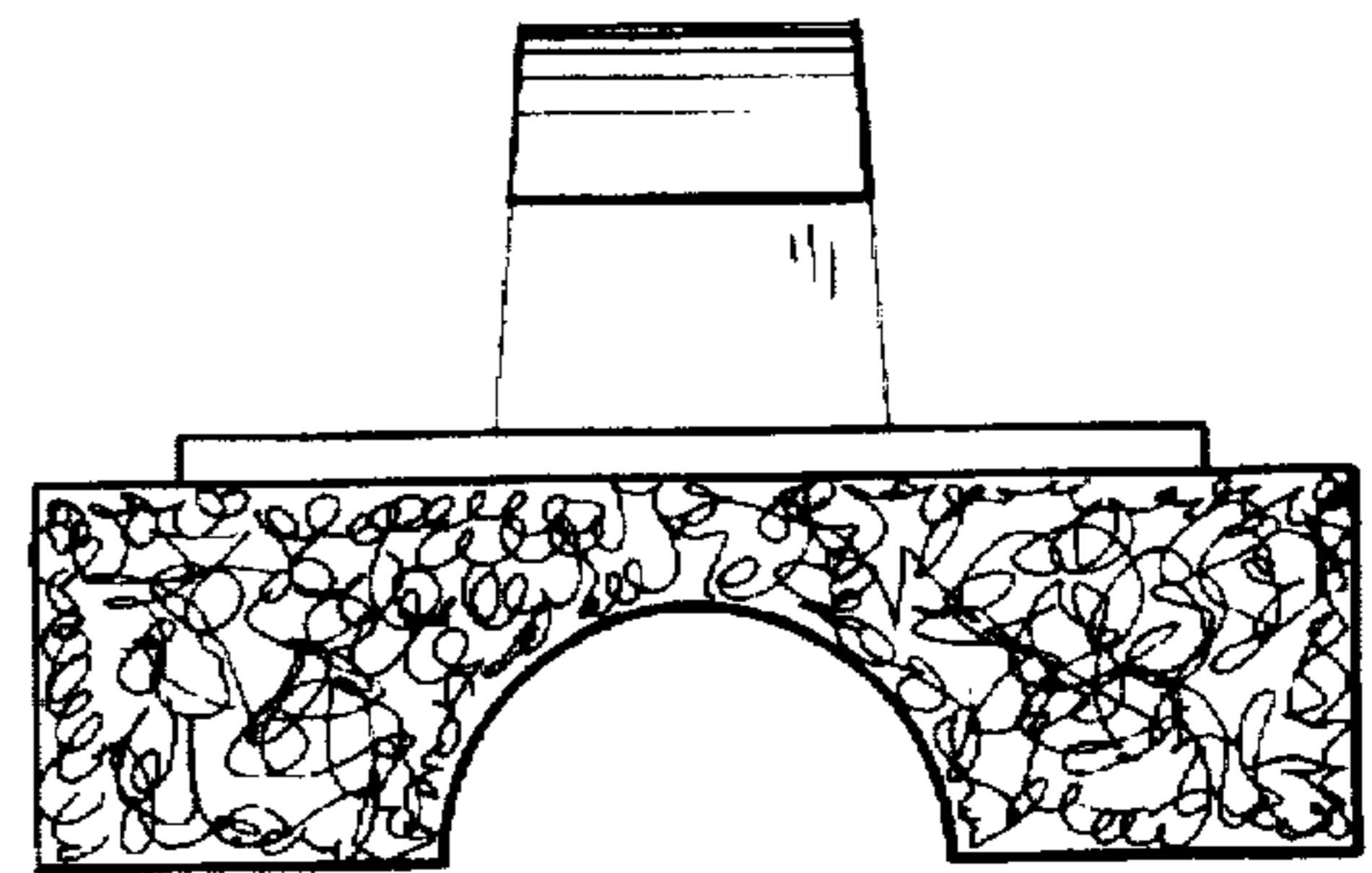

Fig. 10

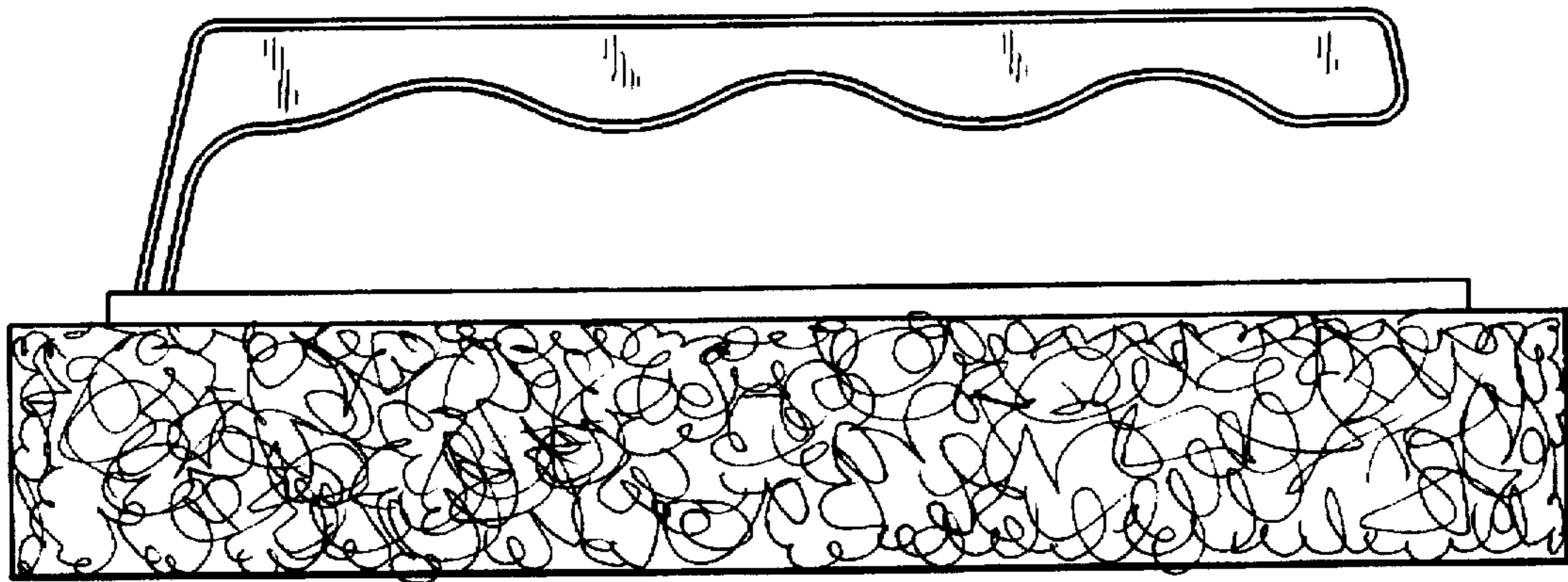

Fig. 11

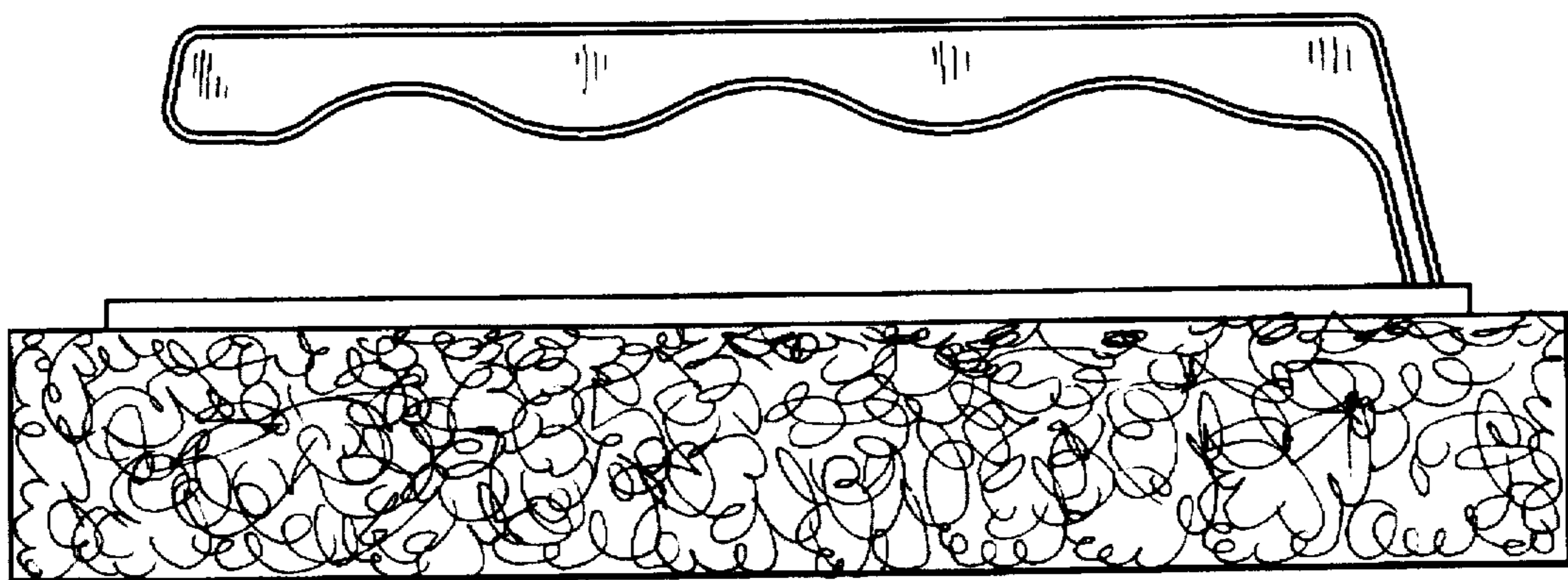

Fig. 12

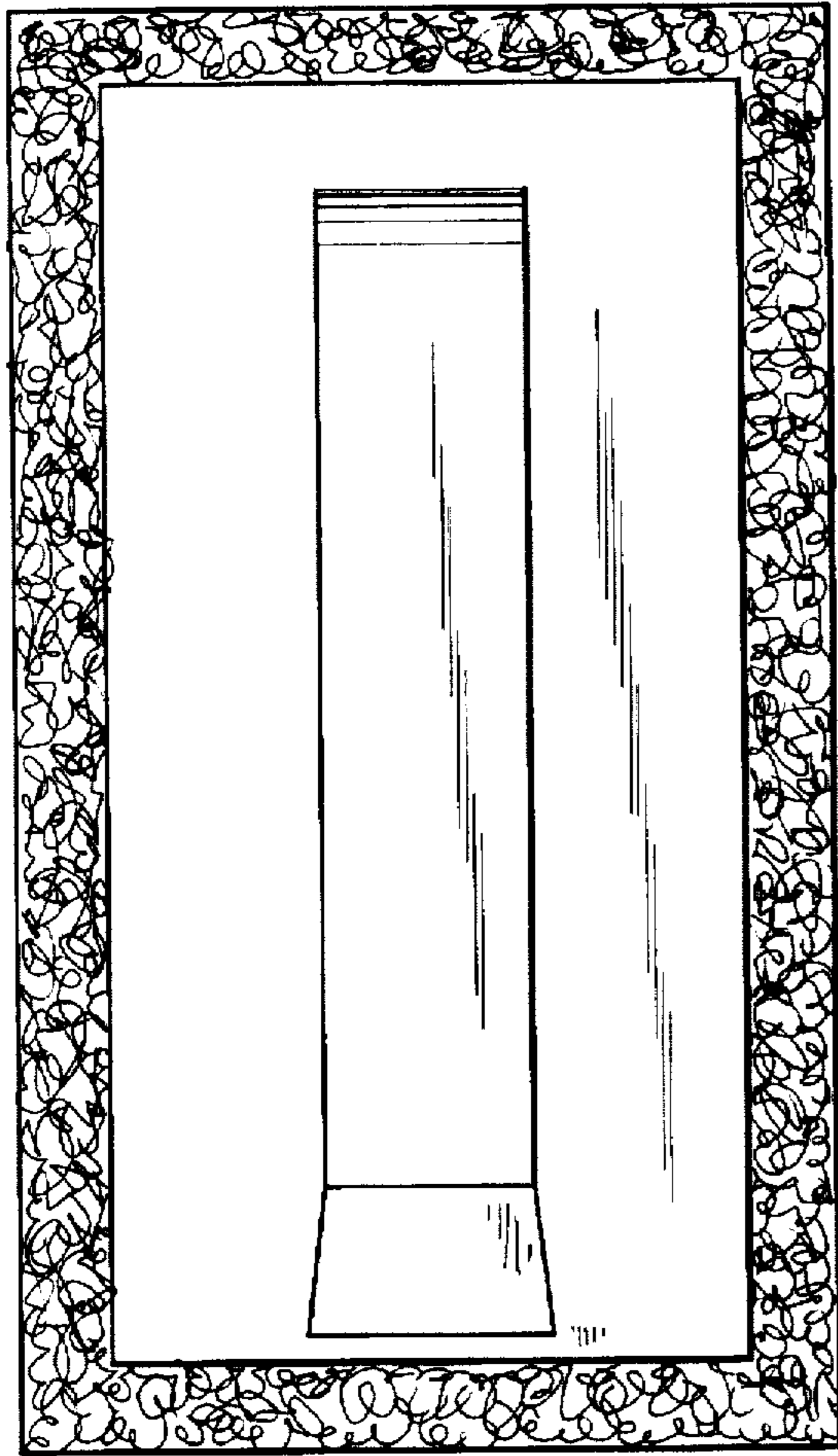

Fig. 13

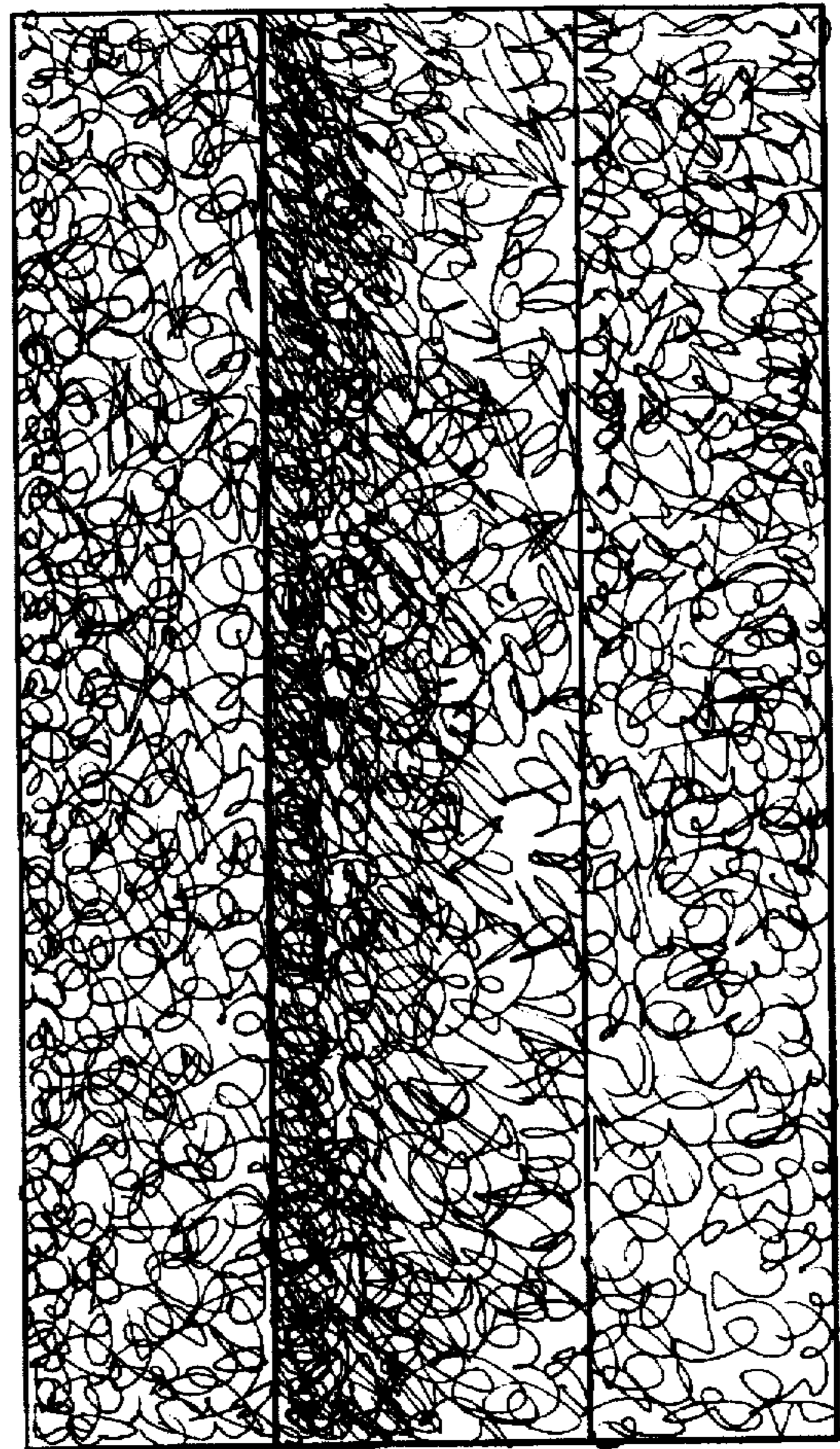

Fig. 14