



US00D392035S

United States Patent [19]

[11] Patent Number: **Des. 392,035**

Gee, II et al.

[45] Date of Patent: ****Mar. 10, 1998**

[54] **COMBINED CEILING FAN MOTOR HOUSING, SWITCH HOUSING, AND BLADE IRONS UNIT**

Primary Examiner—Lisa Lichtenstein
Attorney, Agent, or Firm—Baker, Donelson, Bearman & Caldwell

[75] Inventors: **Jack W. Gee, II**, Memphis; **Masao Tsuji**, Germantown, both of Tenn.

[57] CLAIM

[73] Assignee: **Hunter Fan Company**, Memphis, Tenn.

The ornamental design for a combined ceiling fan motor housing, switch housing, and blade irons unit, as shown and described.

[**] Term: **14 Years**

DESCRIPTION

[21] Appl. No.: **58,246**

FIG. 1 is a perspective view of a combined ceiling fan motor housing, switch housing, and blade irons unit, showing our new design;

[22] Filed: **Aug. 9, 1996**

[51] LOC (6) Cl. **23-04**

FIG. 2 is an additional perspective view showing environmental structure, the broken lines forming no part of the design;

[52] U.S. Cl. **D23/411; D23/377**

[58] Field of Search **D23/377, 379, D23/385, 411; D26/81-86, 88, 51, 59, 72; 416/5, 210 R; 392/364; 362/96**

FIG. 3 is a front elevational view thereof;

[56] References Cited

U.S. PATENT DOCUMENTS

- D. 349,336 8/1994 Tsuji D23/377
- D. 358,877 5/1995 Tsuji D23/377

FIG. 4 is a right side elevational view thereof;

FIG. 5 is a rear elevational view thereof;

FIG. 6 is a left side elevational view thereof;

FIG. 7 is a bottom view thereof; and,

FIG. 8 is a top view thereof.

OTHER PUBLICATIONS

Winnower Fan Co. Cat, p. 5, Ceiling Fan A.
Hunter Fan Co. Cat., p. 27, Ceiling Fan B, top left side of page.

1 Claim, 8 Drawing Sheets

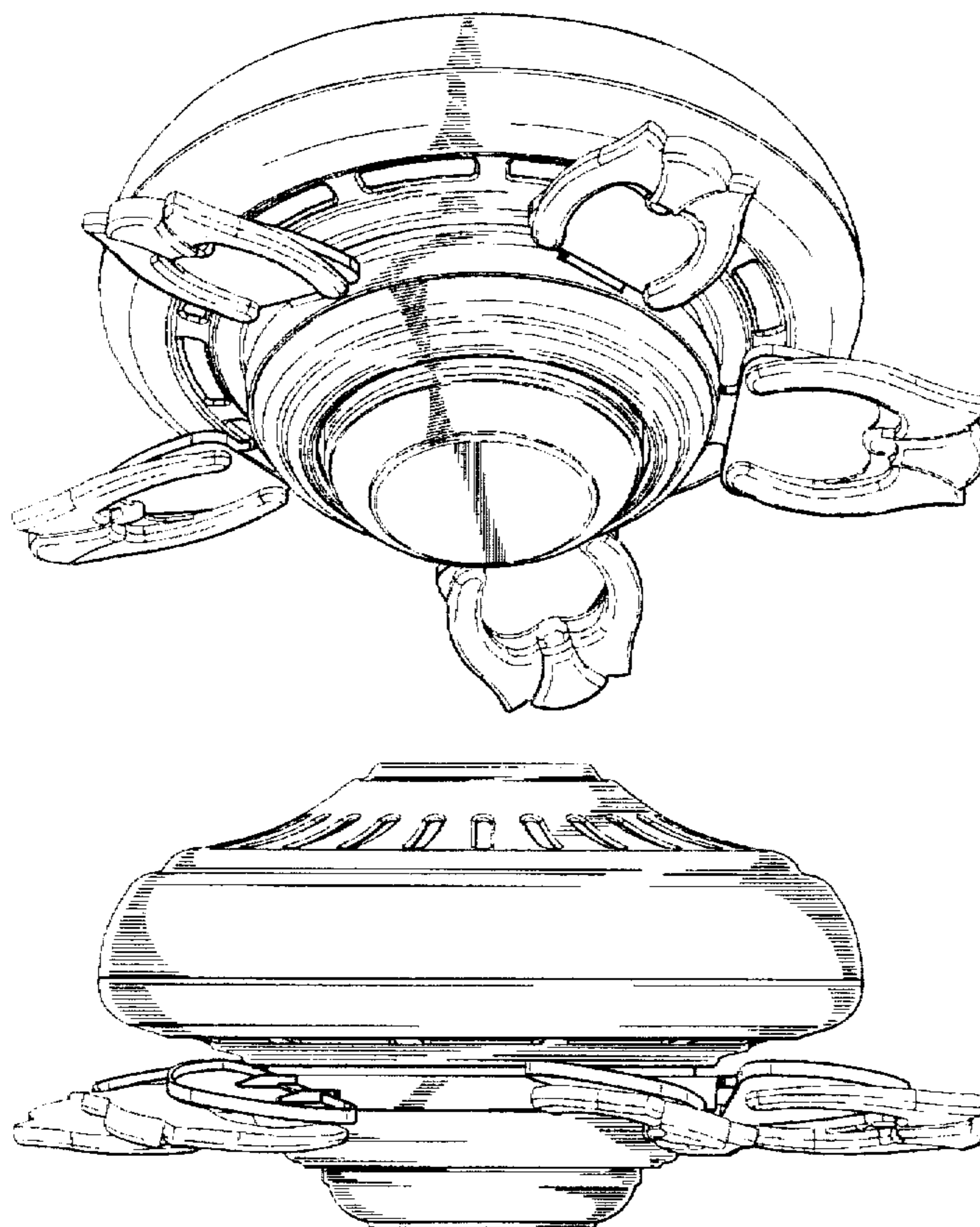

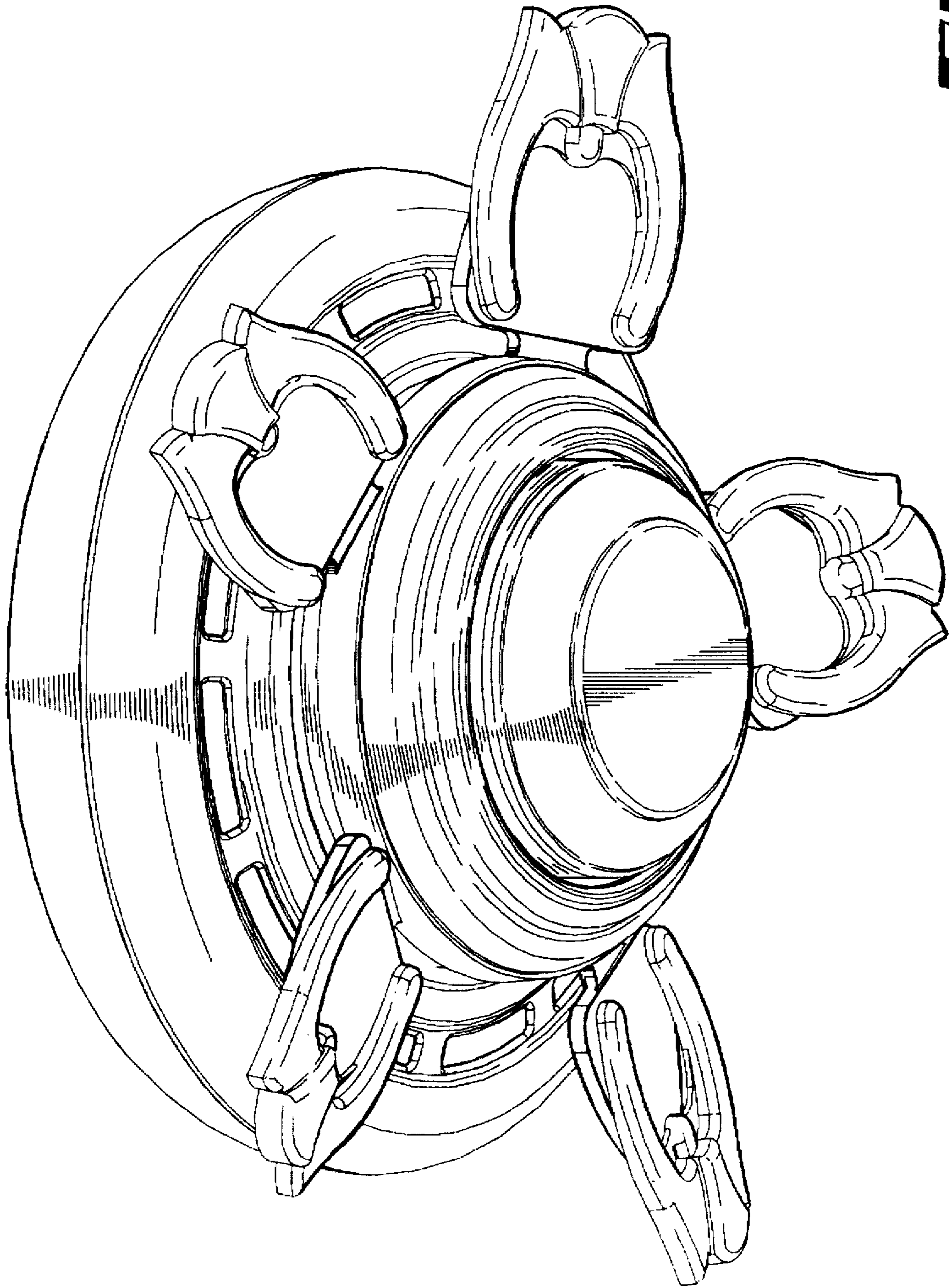

FIG 1

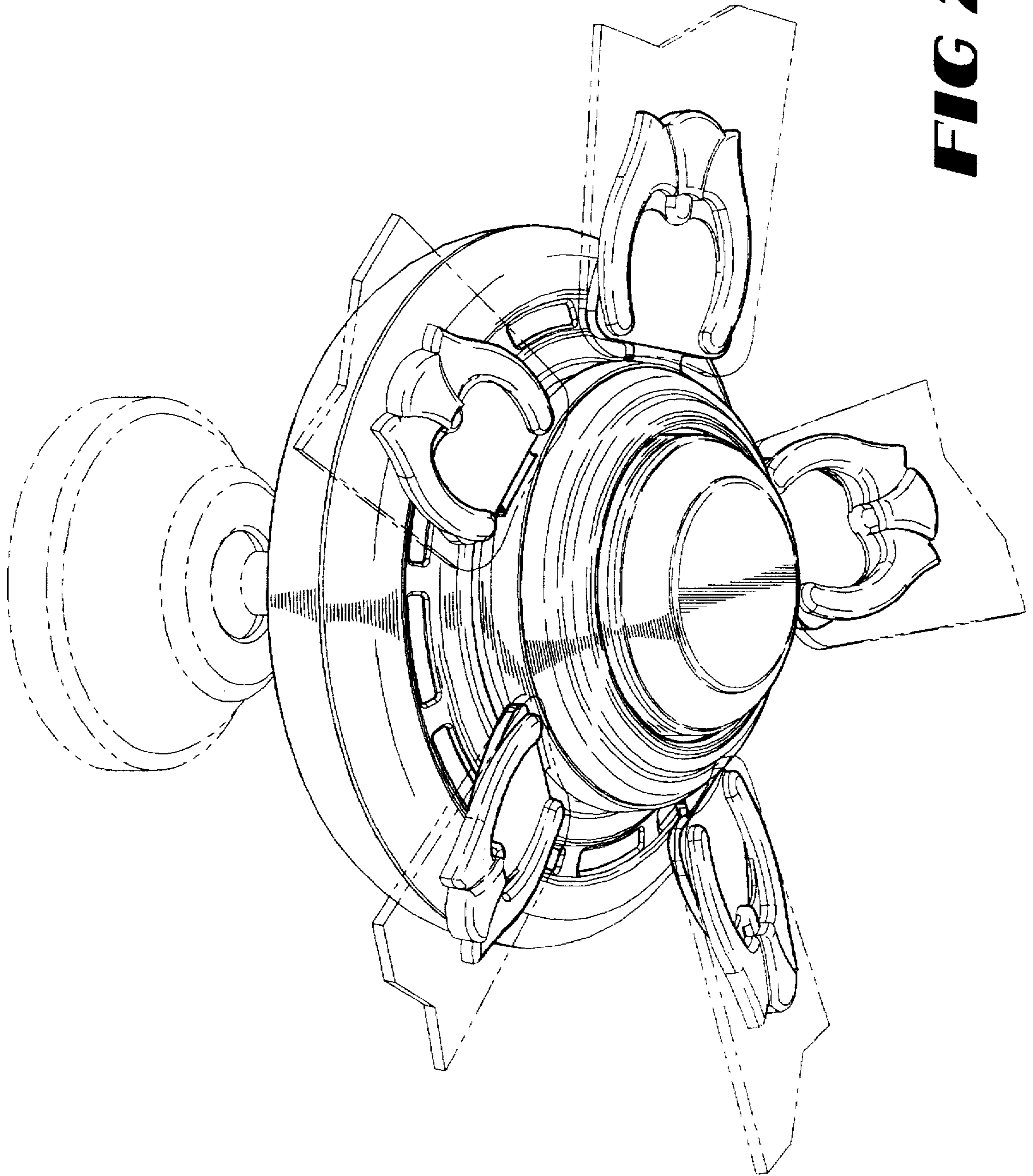

FIG 2

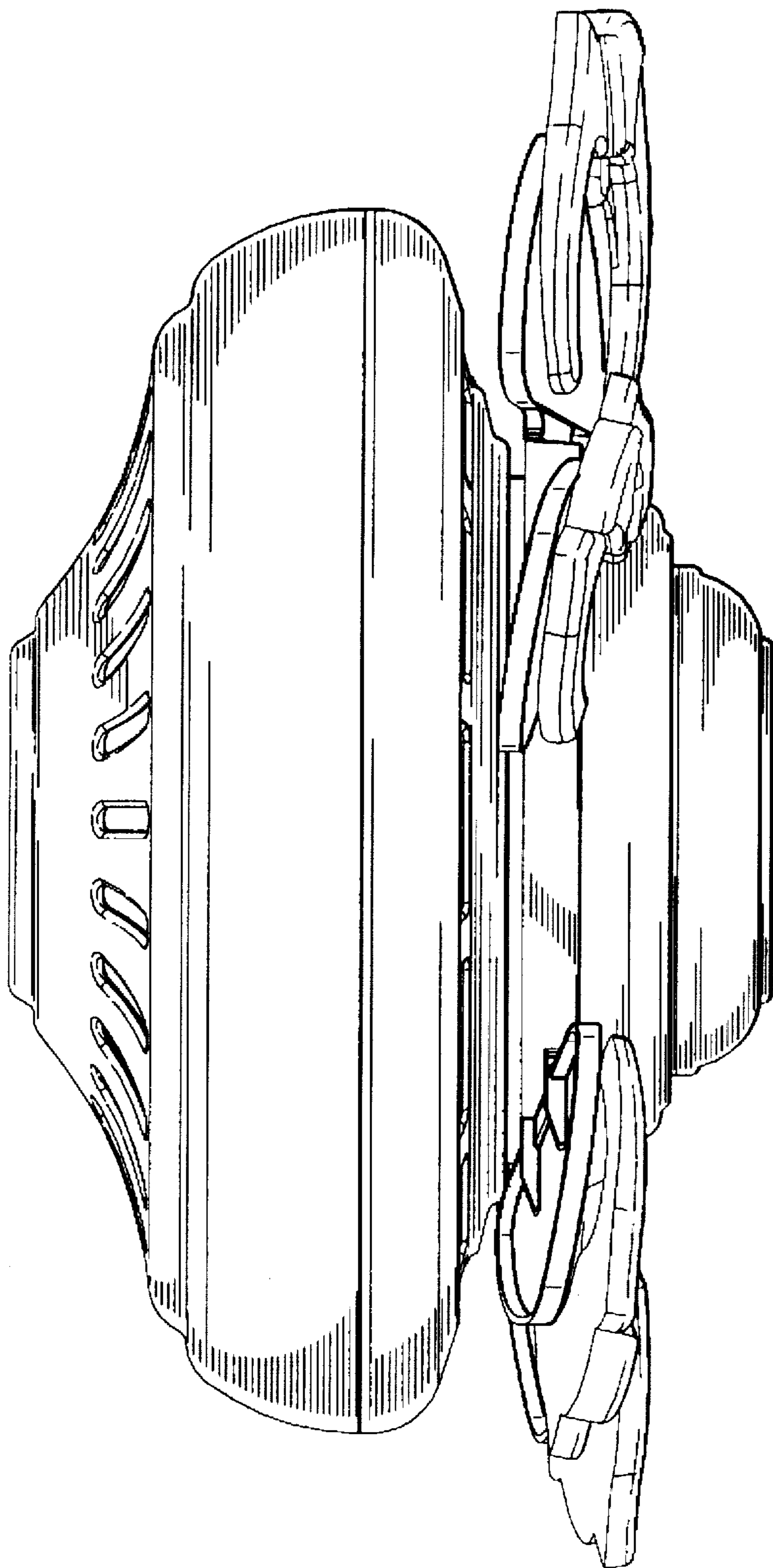

FIG 3

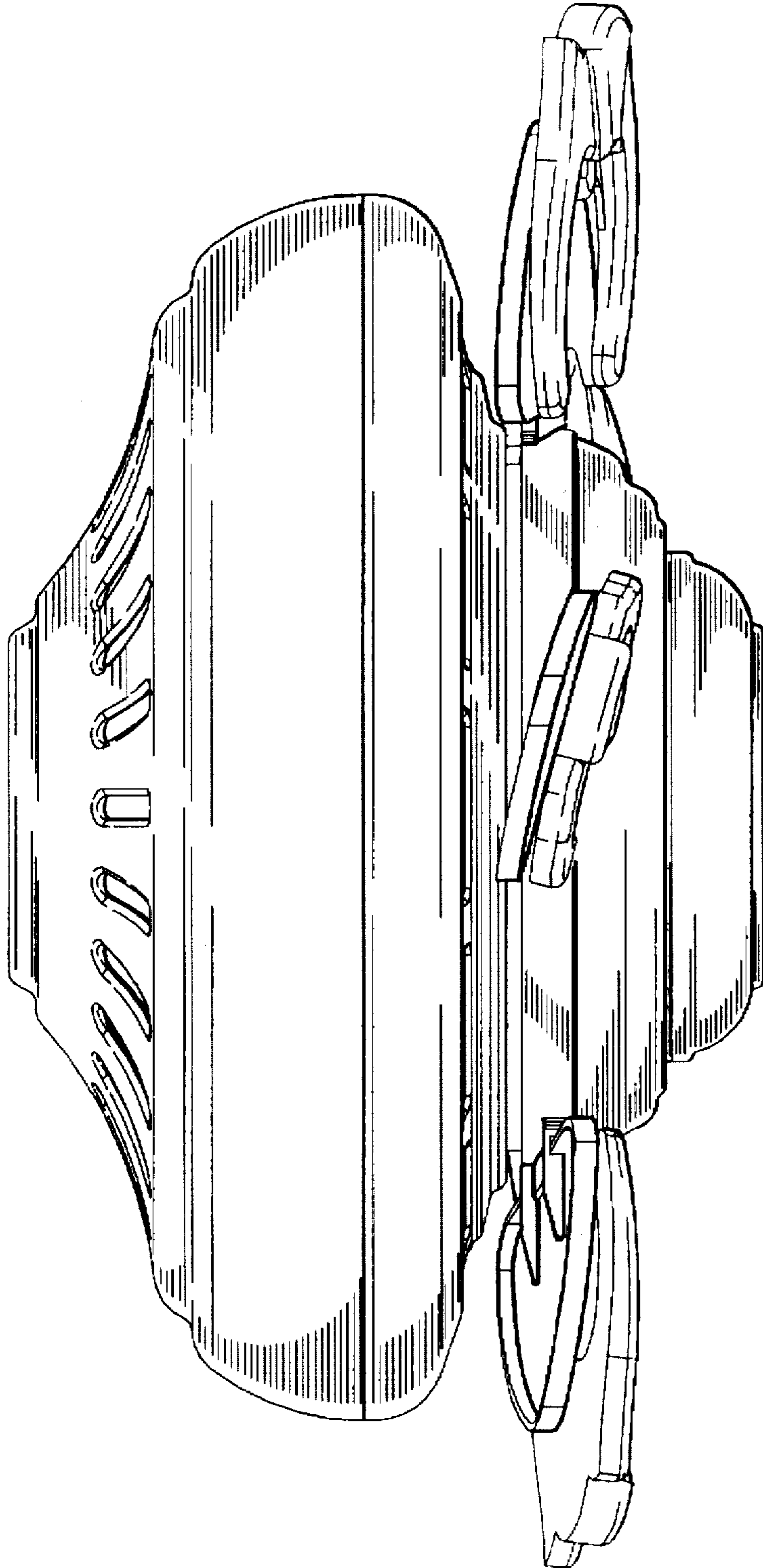

FIG 4

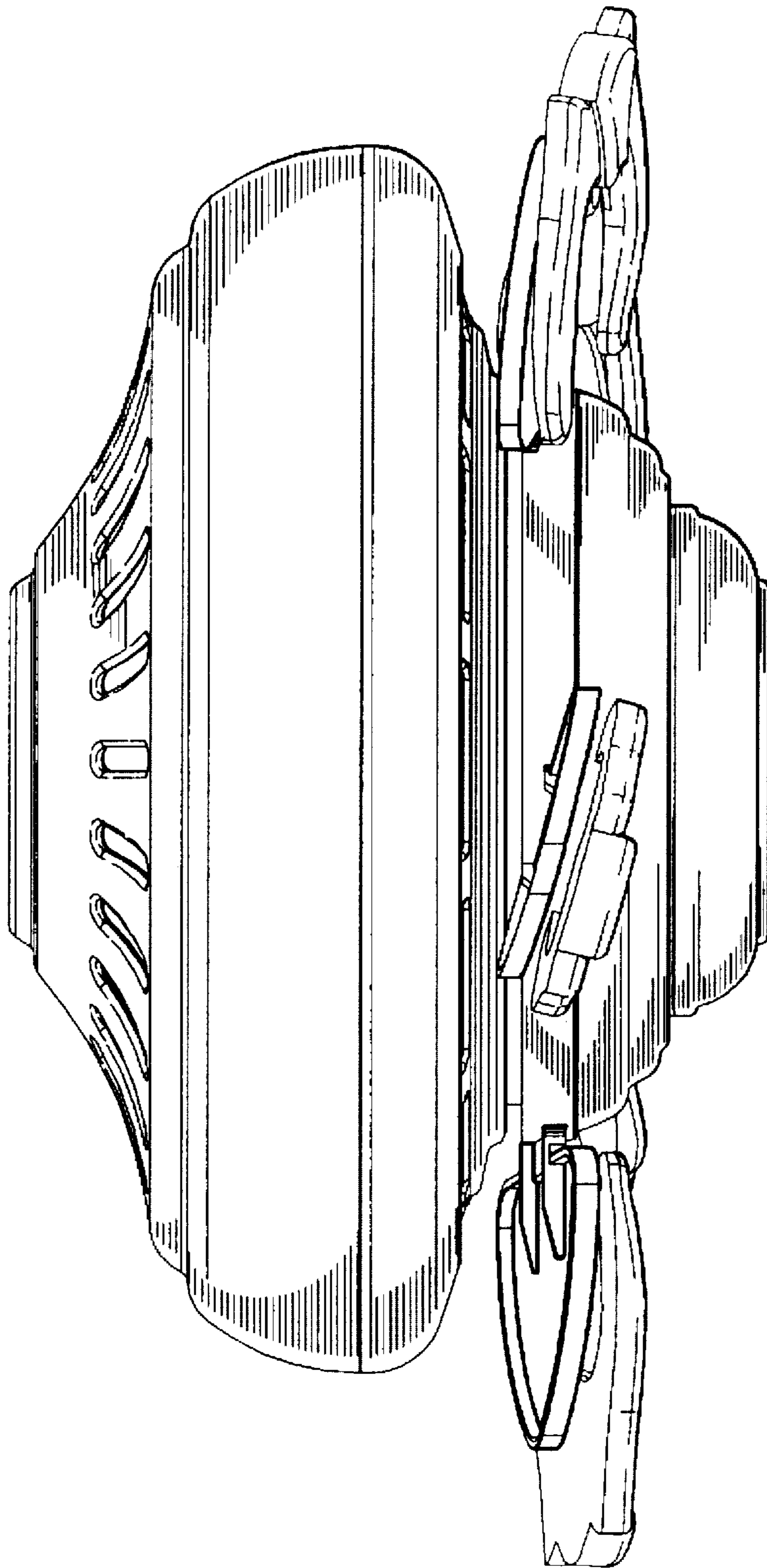

FIG 5

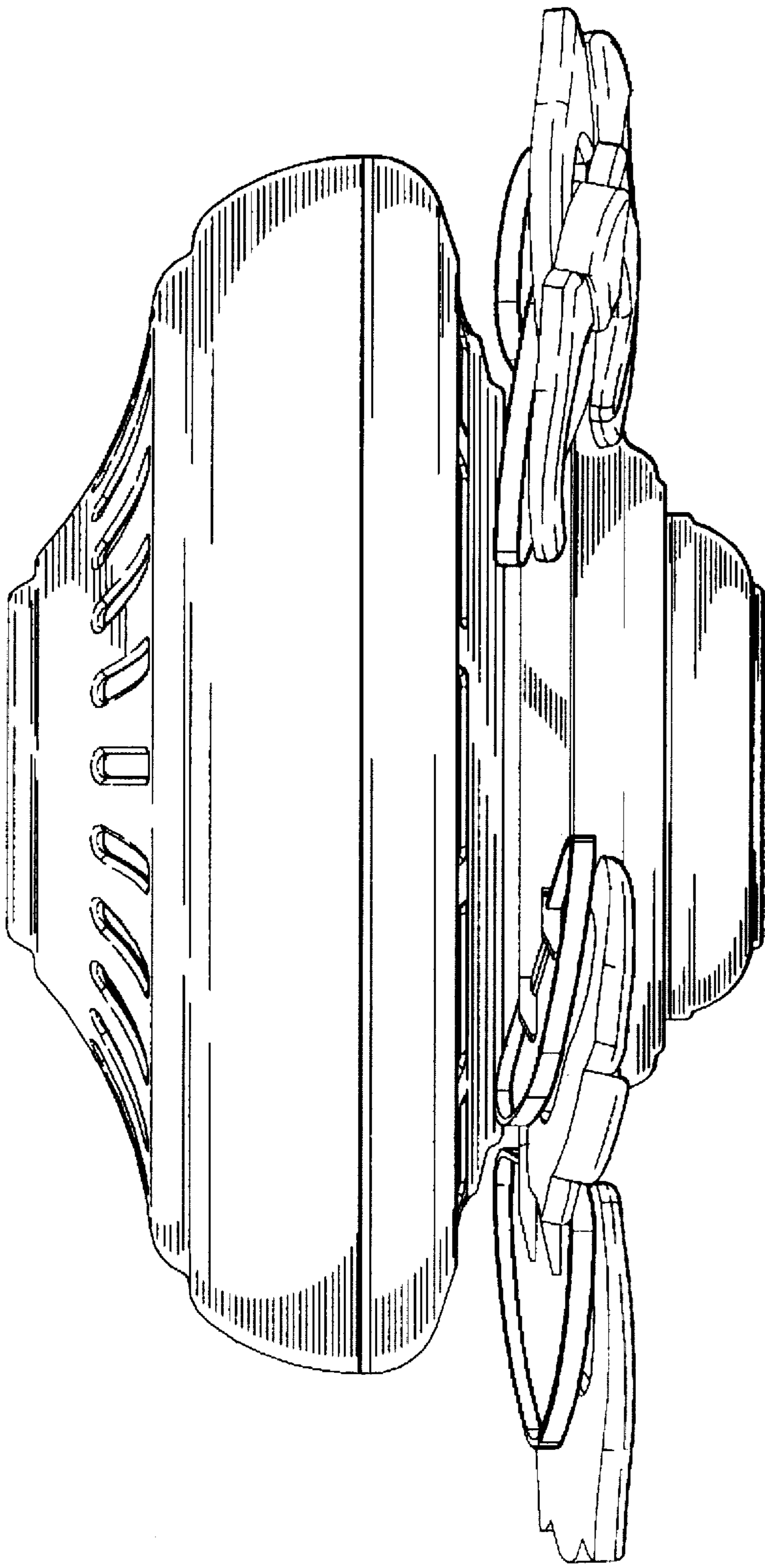

FIG 6

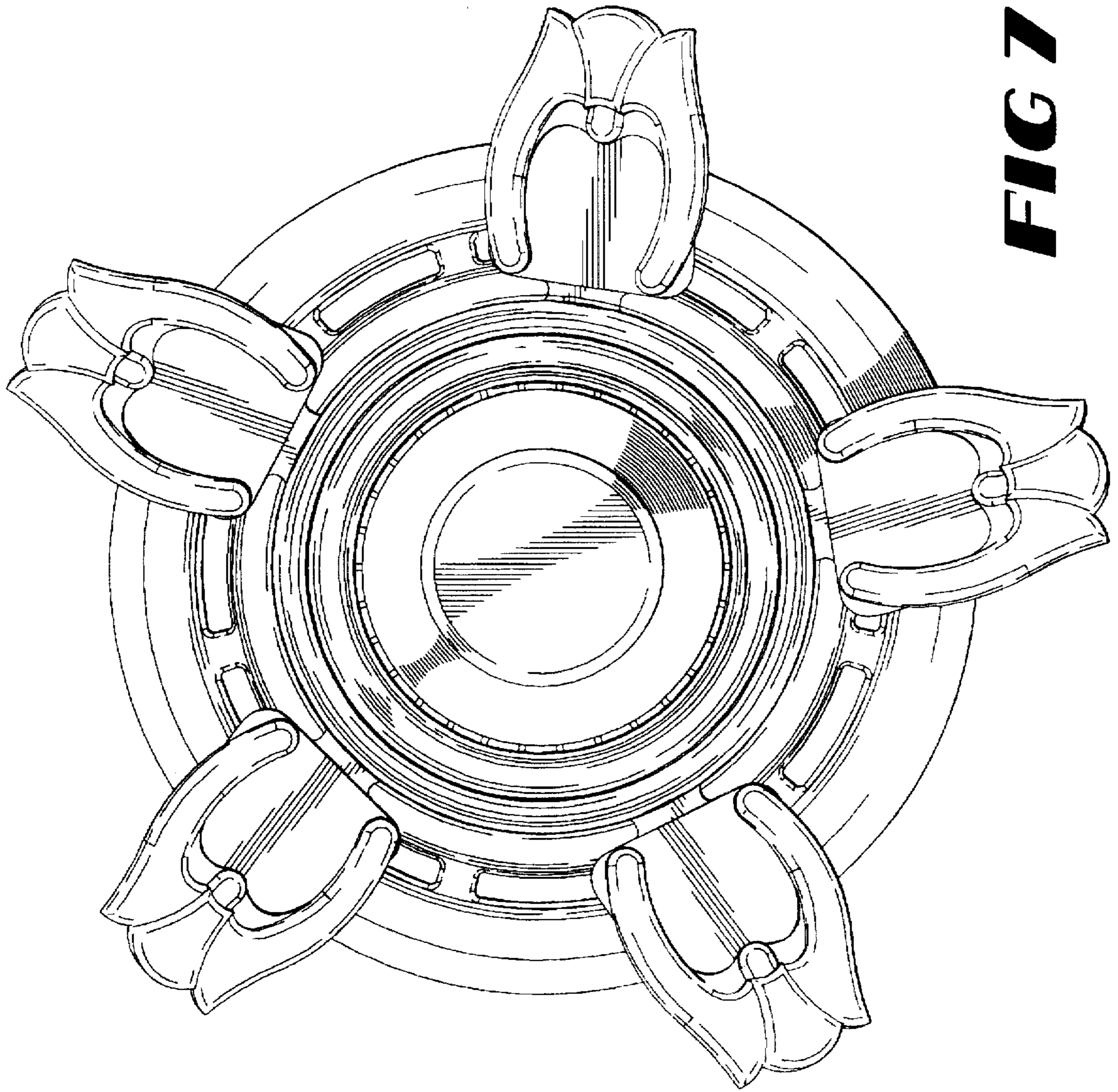

FIG 7

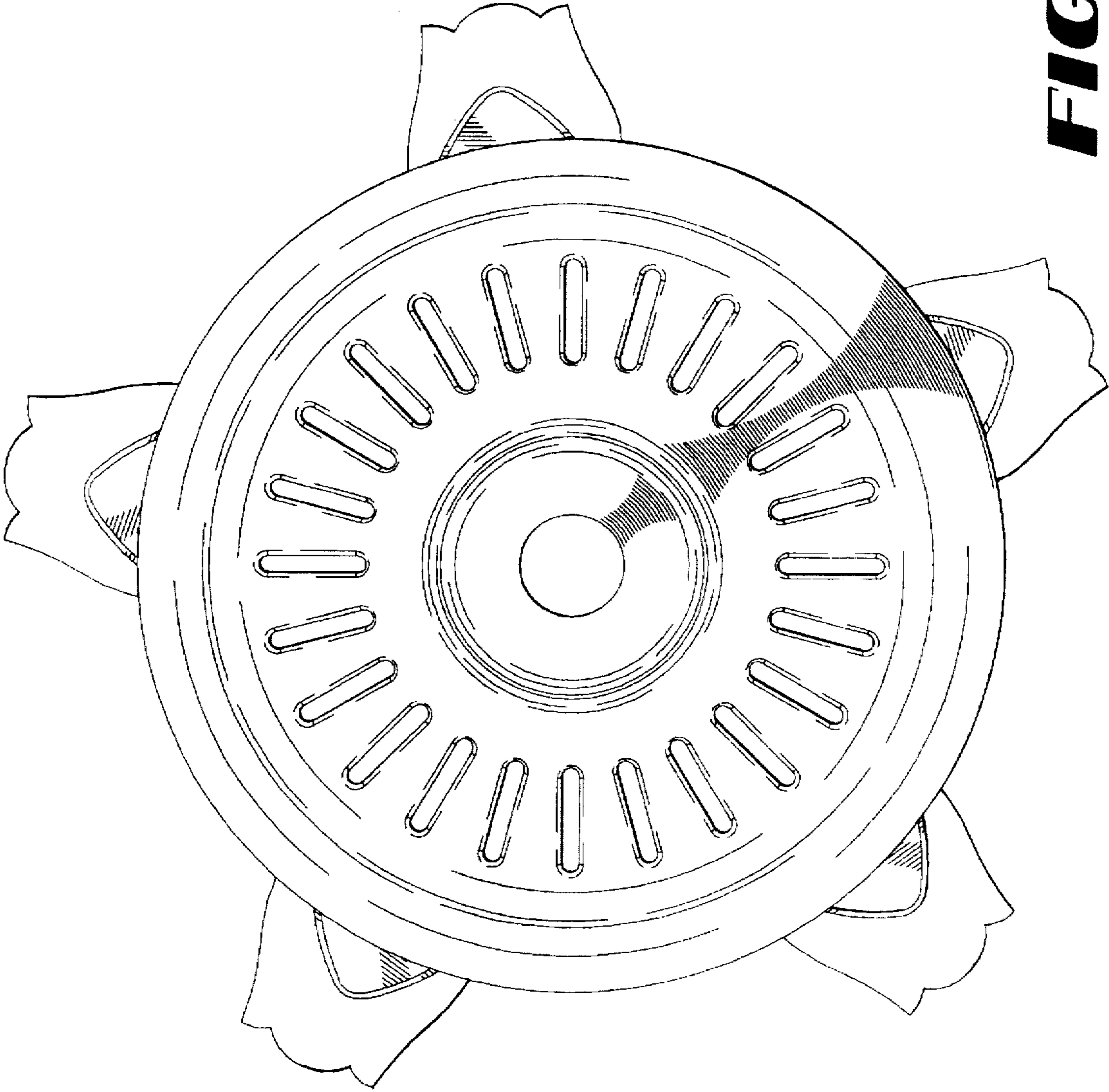

FIG 8