



US00D391983S

United States Patent [19]
Yamaguchi

[11] **Patent Number: Des. 391,983**
[45] **Date of Patent: **Mar. 10, 1998**

[54] **STAMP**
[75] **Inventor: Yasutake Yamaguchi, Chiryu, Japan**
[73] **Assignee: Brother Kogyo Kabushiki Kaisha, Nagoya, Japan**
[**] **Term: 14 Years**

D. 326,865 6/1992 Satoh D18/15
D. 348,898 7/1994 Nagasawa D18/15
D. 367,290 2/1996 Sculler et al. D18/15
D. 378,827 4/1997 Uchiyama D18/15

Primary Examiner—Louis S. Zarfes
Assistant Examiner—Monica A. Weingart
Attorney, Agent, or Firm—Oliff & Berridge, PLC

[21] **Appl. No.: 65,175**
[22] **Filed: Jan. 23, 1997**

[57] **CLAIM**
The ornamental design for a stamp, as shown and described.

[30] **Foreign Application Priority Data**

DESCRIPTION

Aug. 8, 1996 [JP] Japan 8-24189

[51] **LOC (6) Cl. 19-02**
[52] **U.S. Cl. D18/15; D18/14**
[58] **Field of Search D18/14-19; 107/111, 107/368, 371-373, 405**

FIG. 1 is a top plan view of a stamp;
FIG. 2 is a front view of the stamp;
FIG. 3 is a rear view of the stamp;
FIG. 4 is a bottom plan view of the stamp;
FIG. 5 is a left side view of the stamp;
FIG. 6 is a right side view of the stamp; and,
FIG. 7 is a perspective view of the stamp.

[56] **References Cited**

U.S. PATENT DOCUMENTS

D. 323,527 1/1992 Weir et al. D18/15

1 Claim, 4 Drawing Sheets

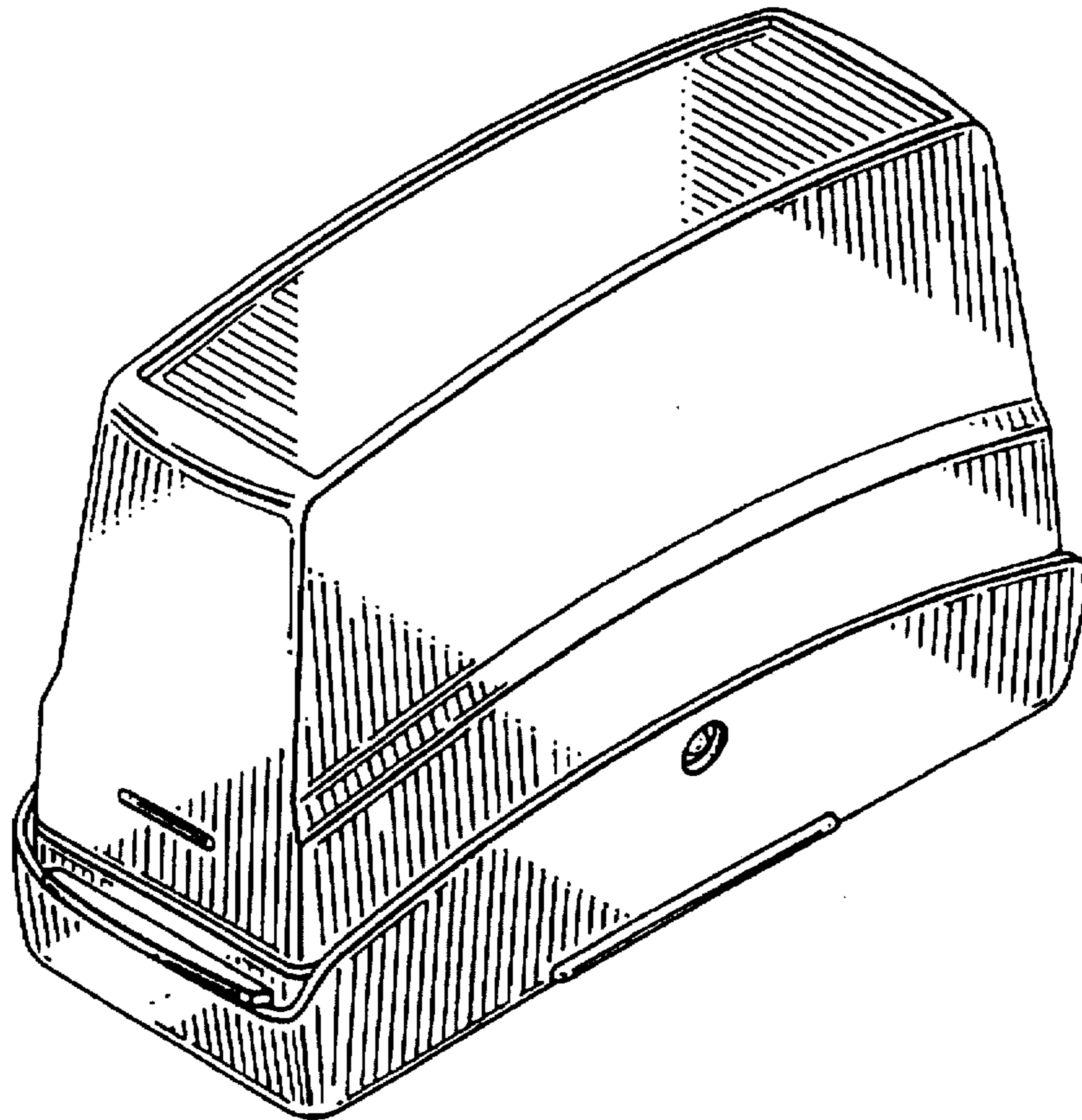

FIG. 1

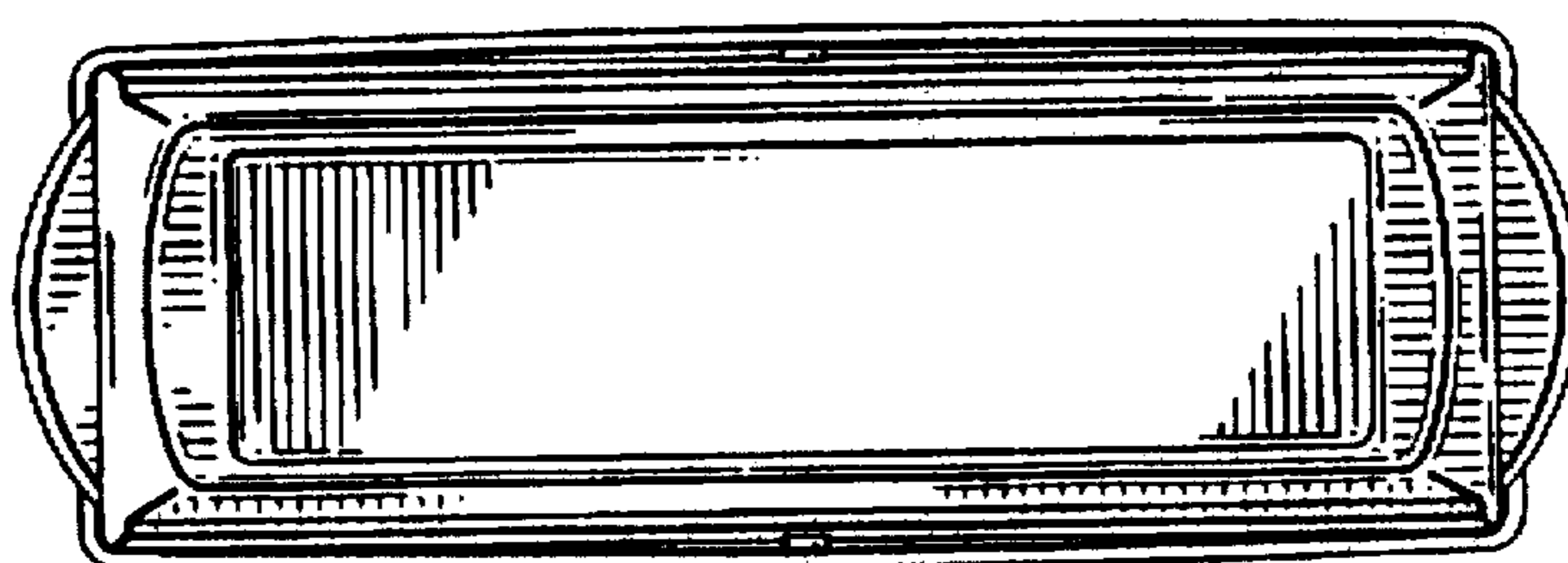

FIG. 2

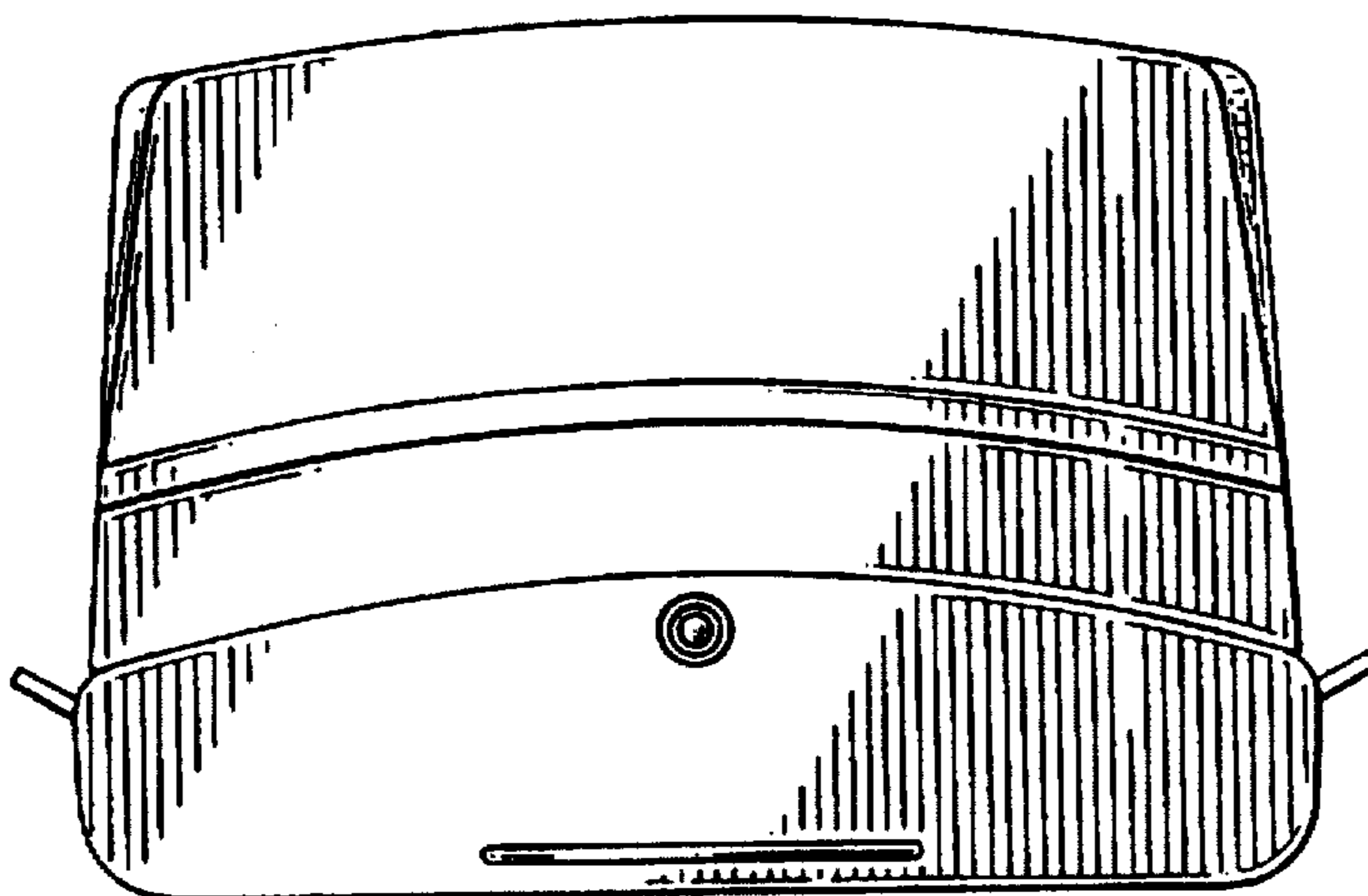

FIG. 3

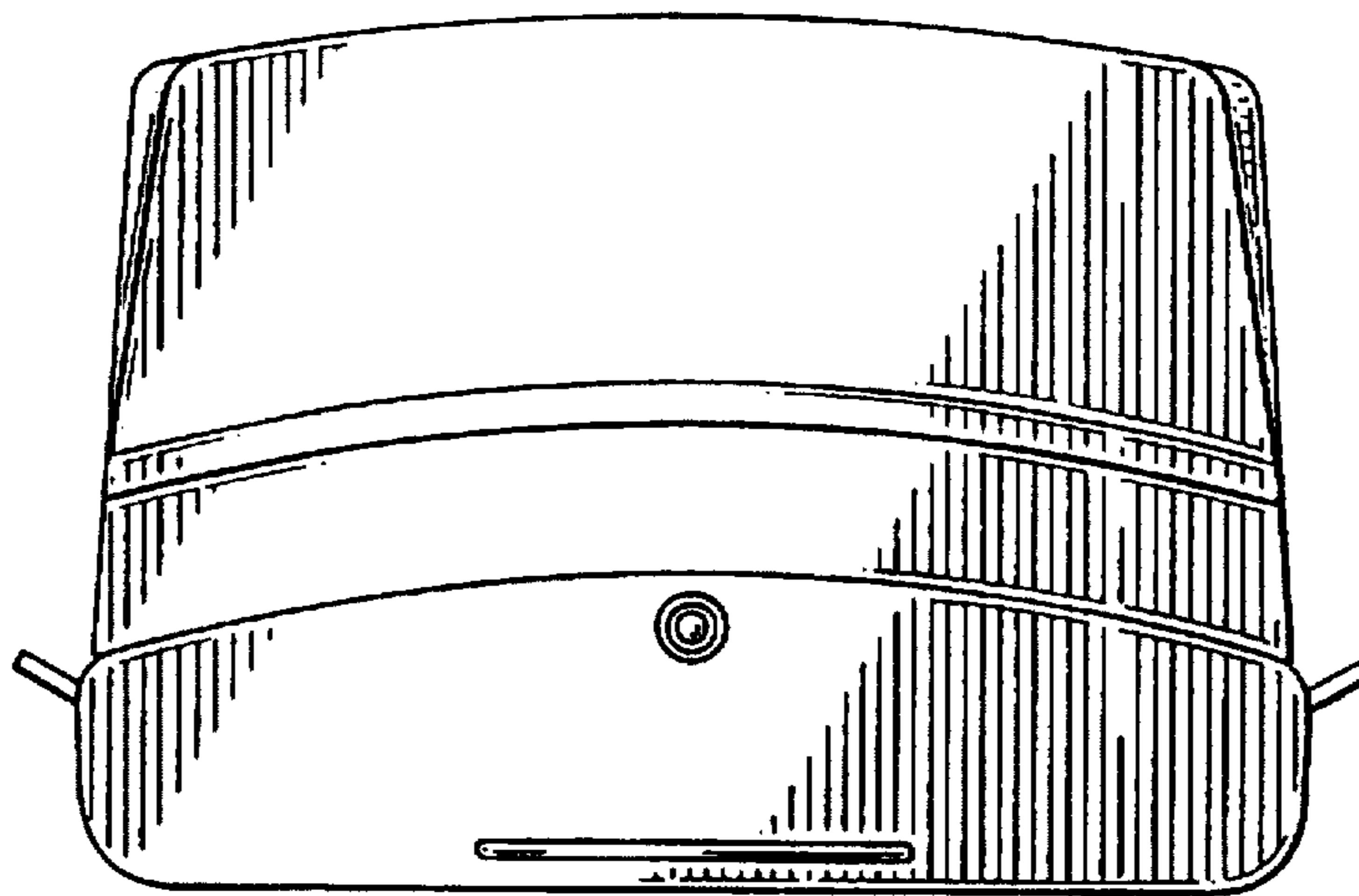

FIG. 4

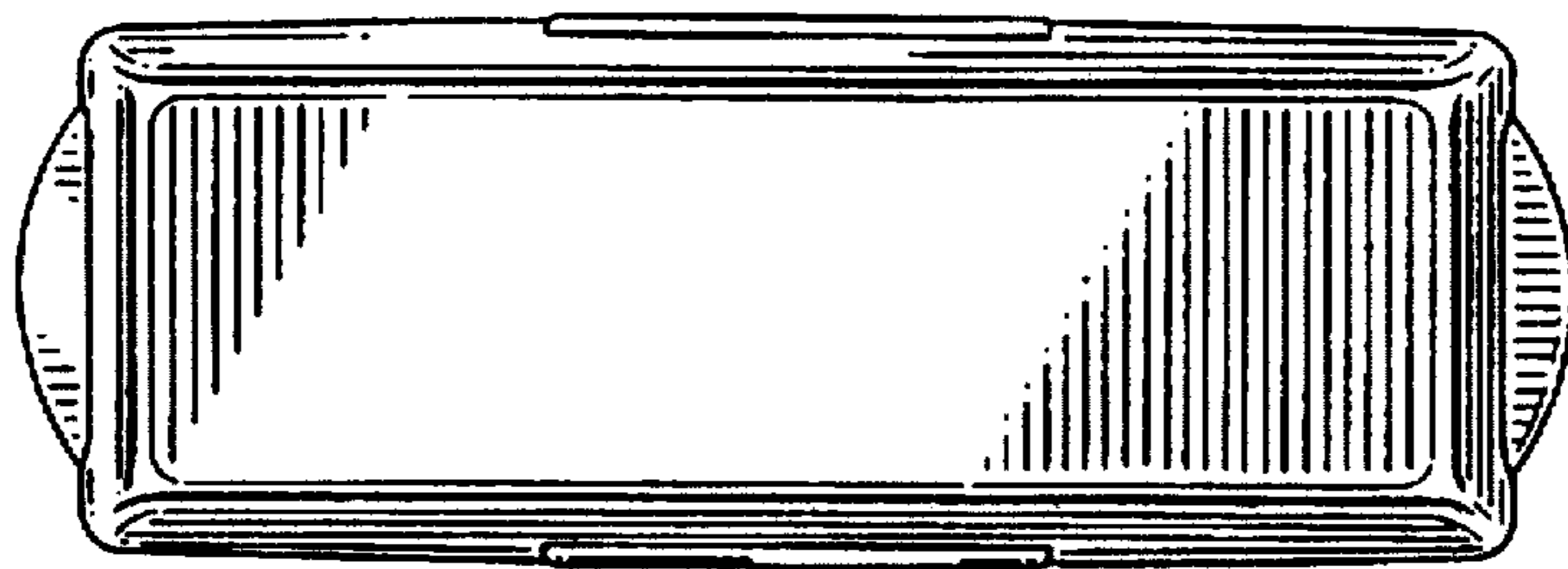

FIG. 5

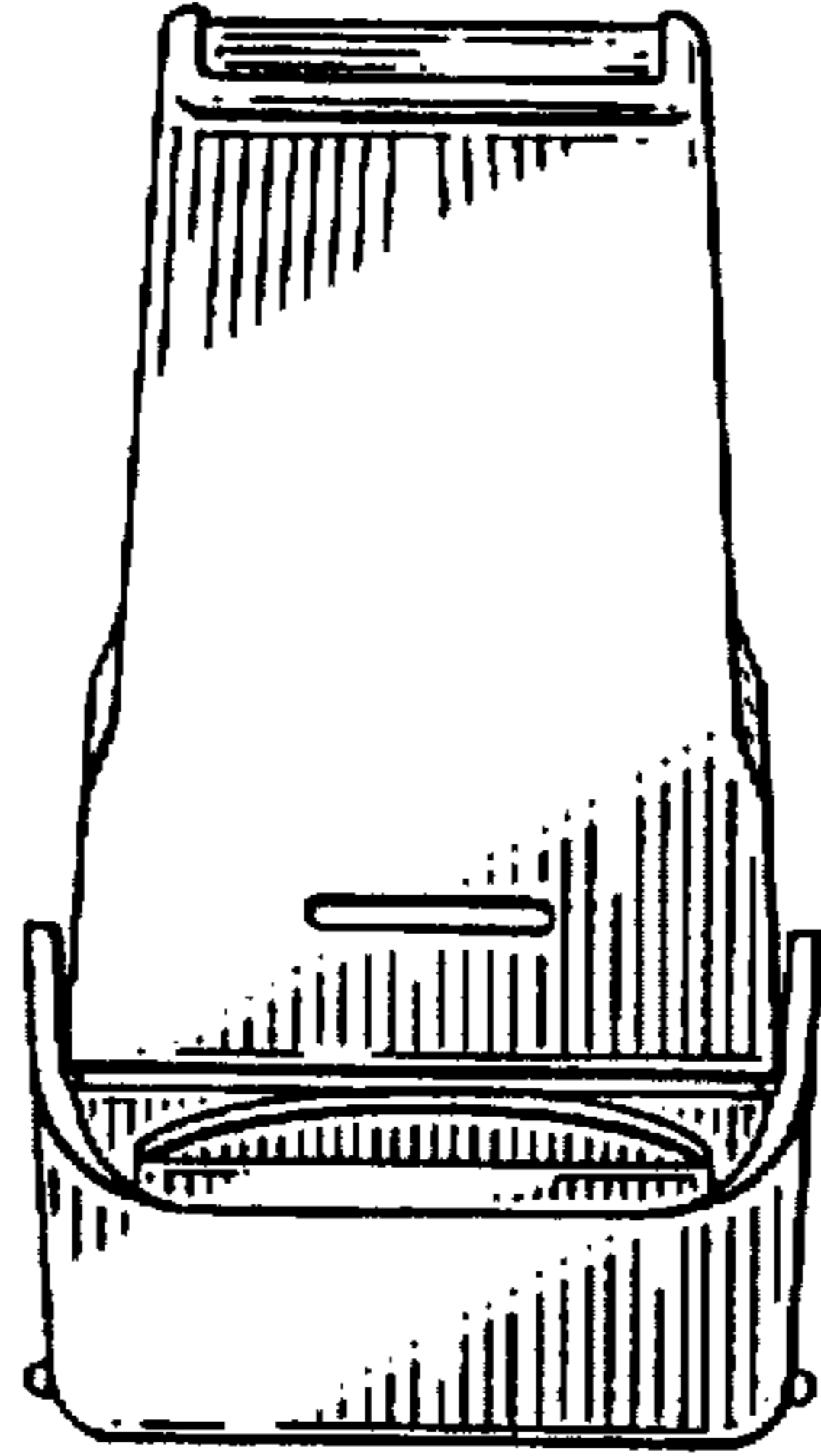

FIG. 6

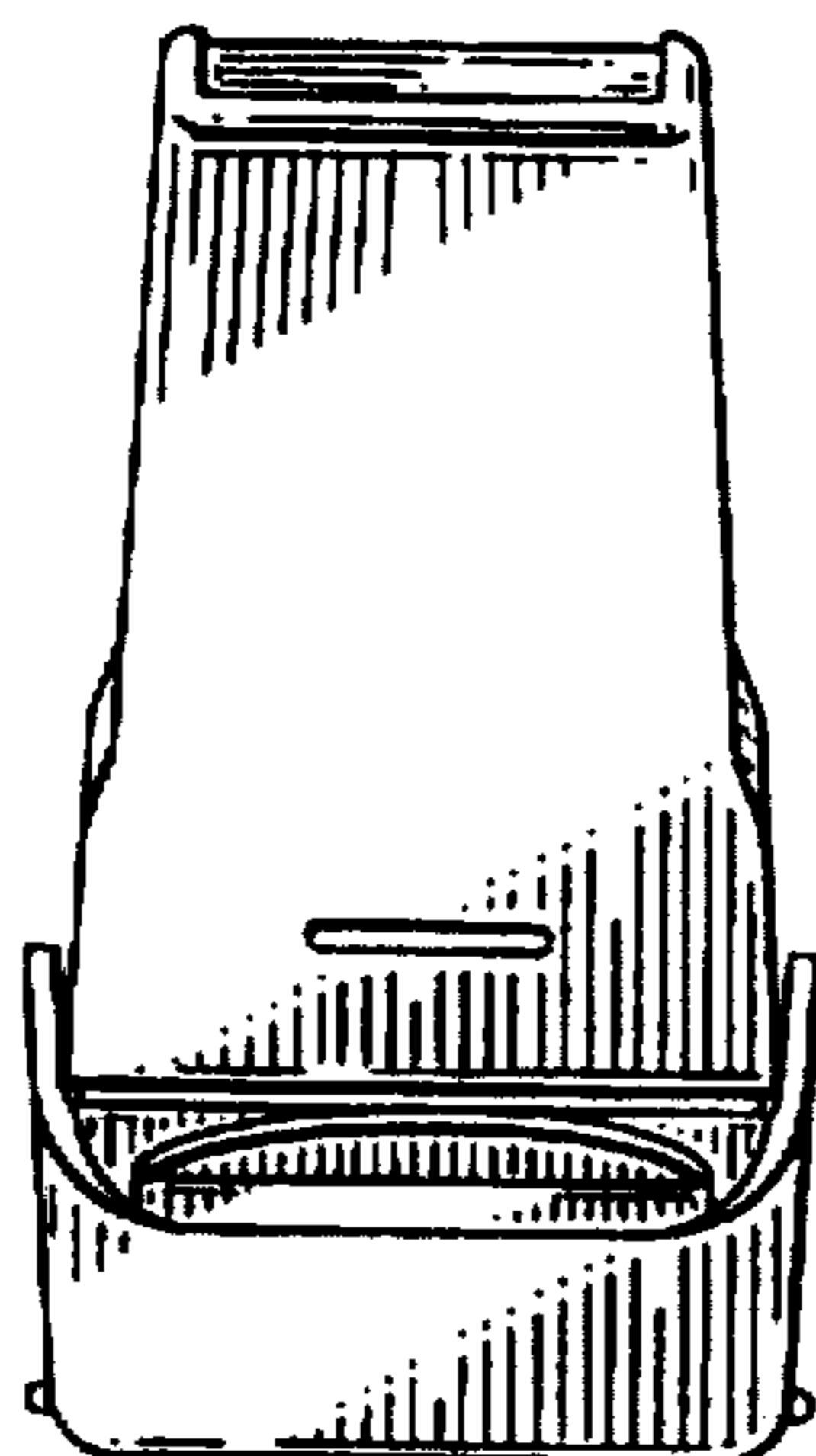

FIG. 7

