



US00D391956S

United States Patent [19]

Prins et al.

[11] Patent Number: Des. 391,956

[45] Date of Patent: **Mar. 10, 1998

[54] TELEPHONE

[75] Inventors: **Hajo Jelmer Prins**, Delft; **René Johan van Geer**, Rijswijk, both of Netherlands

[73] Assignee: **Ditte N.V.**, Netherlands Antilles

[**] Term: **14 Years**

[21] Appl. No.: **63,858**

[22] Filed: **Dec. 17, 1996**

[30] **Foreign Application Priority Data**

Jun. 19, 1996 [NL] Netherlands 7201501

[51] LOC (6) Cl. **14-03**

[52] U.S. Cl. **D14/151**

[58] Field of Search D14/137, 138, D14/140, 142, 147-151, 240, 241, 143, 144, 243; 379/419, 420, 428, 440, 434-436, 454, 455; D21/111

[56] **References Cited**

U.S. PATENT DOCUMENTS

D. 281,243 11/1985 Reichenstein D14/151 X
D. 375,310 11/1996 Wooldridge D14/151

Primary Examiner—Jeffrey Asch
Attorney, Agent, or Firm—Ladas & Parry

[57] **CLAIM**

The ornamental design for a telephone, as shown and described.

DESCRIPTION

FIG. 1 is a perspective view of the telephone showing our new design including a telephone base and a telephone handset;

FIG. 2 is a rear elevational view of the telephone base;

FIG. 3 is a top plan view thereof;

FIG. 4 is a front elevational view thereof;

FIG. 5 is a left side elevational view thereof;

FIG. 6 is a bottom plan view thereof;

FIG. 7 is a right side elevational thereof;

FIG. 8 is a top plan view of the telephone handset;

FIG. 9 is a left side elevational view thereof;

FIG. 10 is a bottom plan view thereof;

FIG. 11 is a rear elevational view thereof; and

FIG. 12 is a front elevational view thereof.

The telephone base and handset have been shown separately in FIGS. 2-12 for convenience of illustration.

The broken line disclosure in FIG. 1 is for illustrative purposes only and form no part of the claimed design. The notch on the bottom edge of the protruding speaker end of the telephone in FIG. 9 has not been shown in FIG. 1 for convenience of illustration.

1 Claim, 4 Drawing Sheets

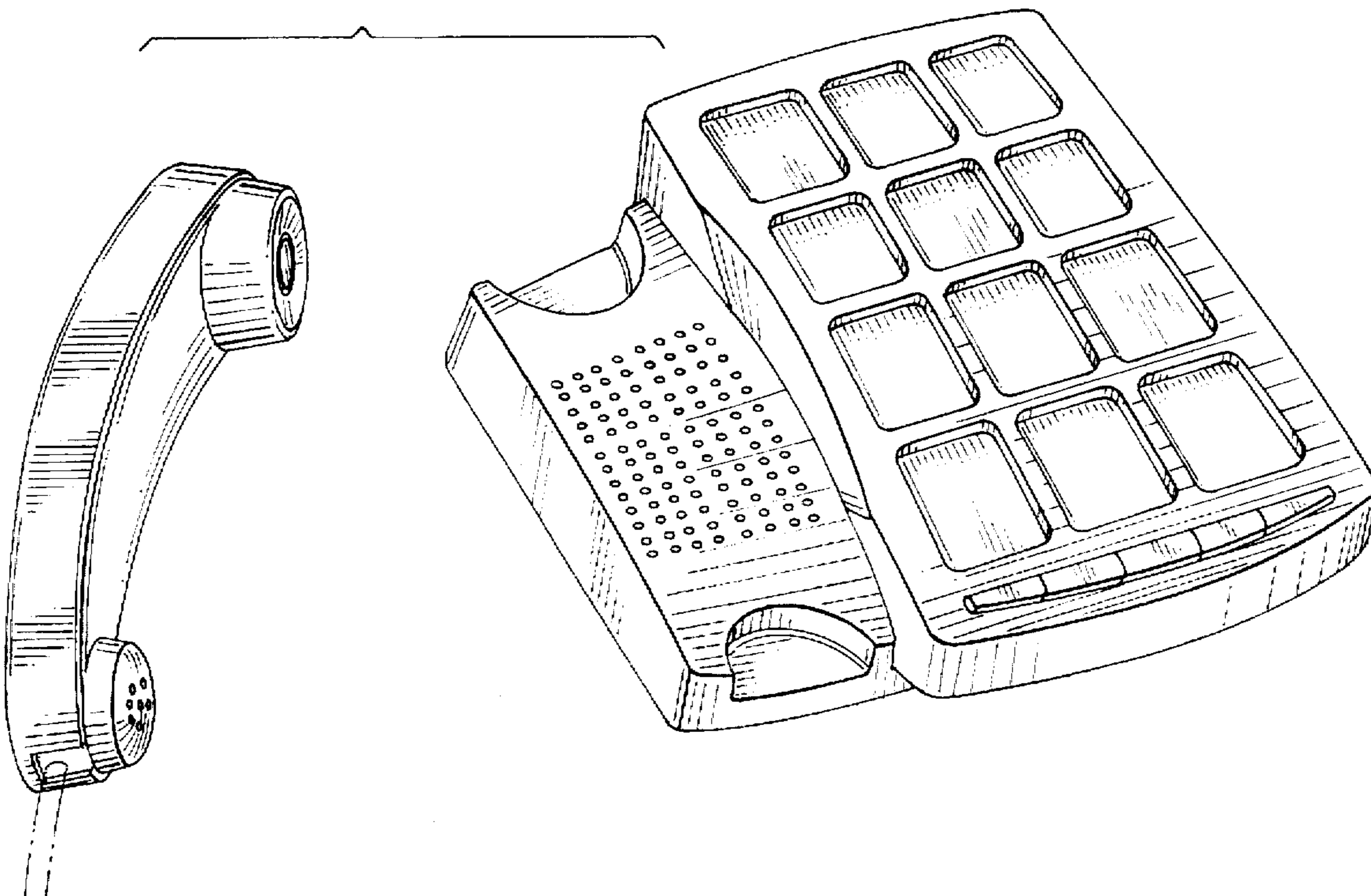

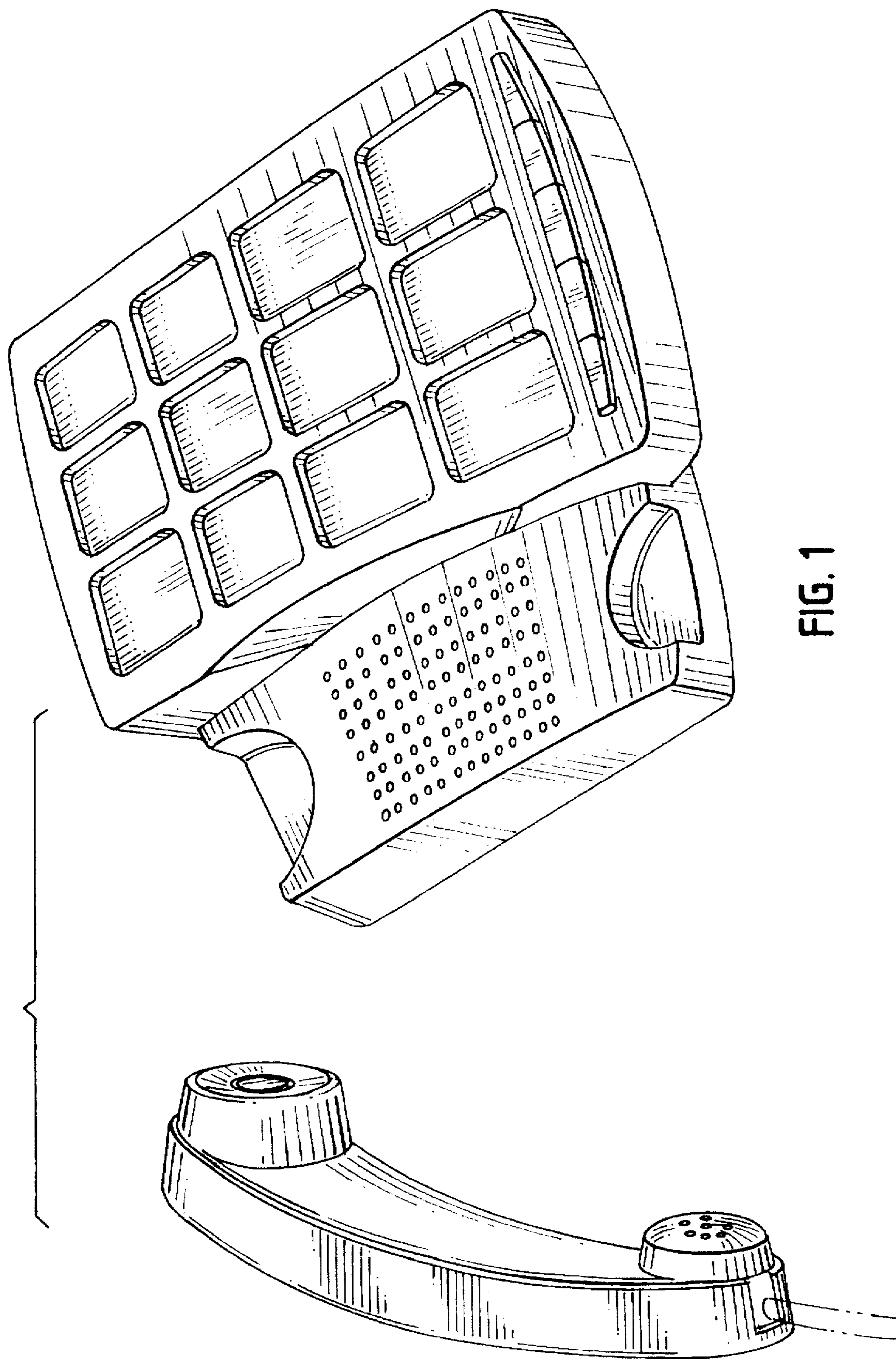

FIG. 1

FIG. 2

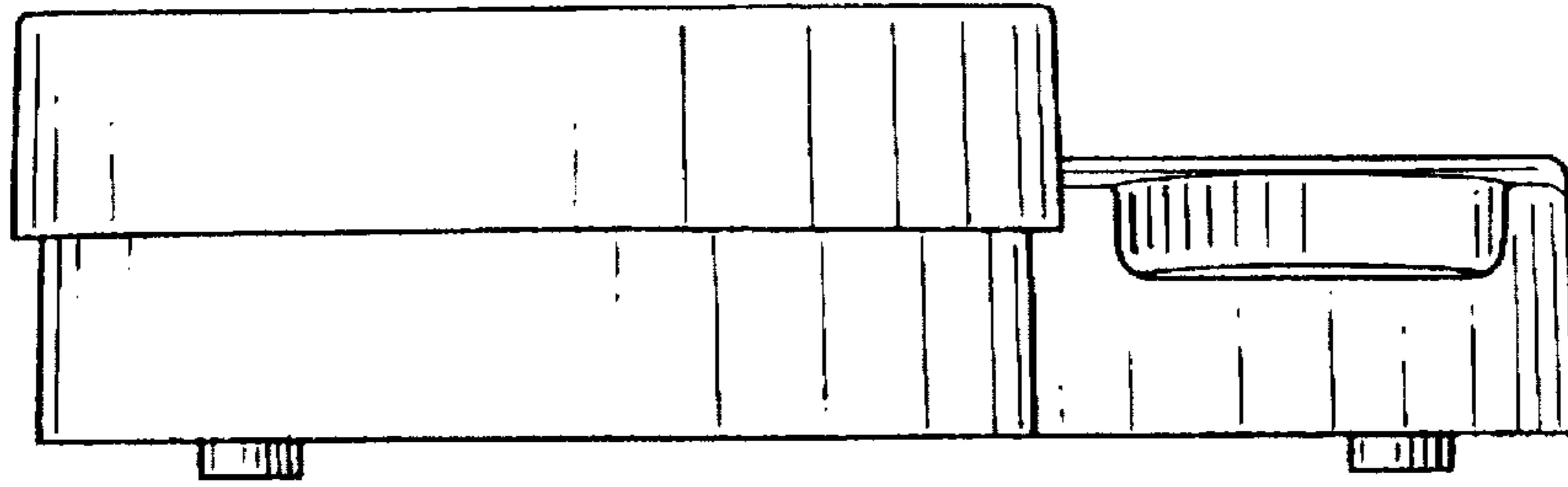

FIG. 3

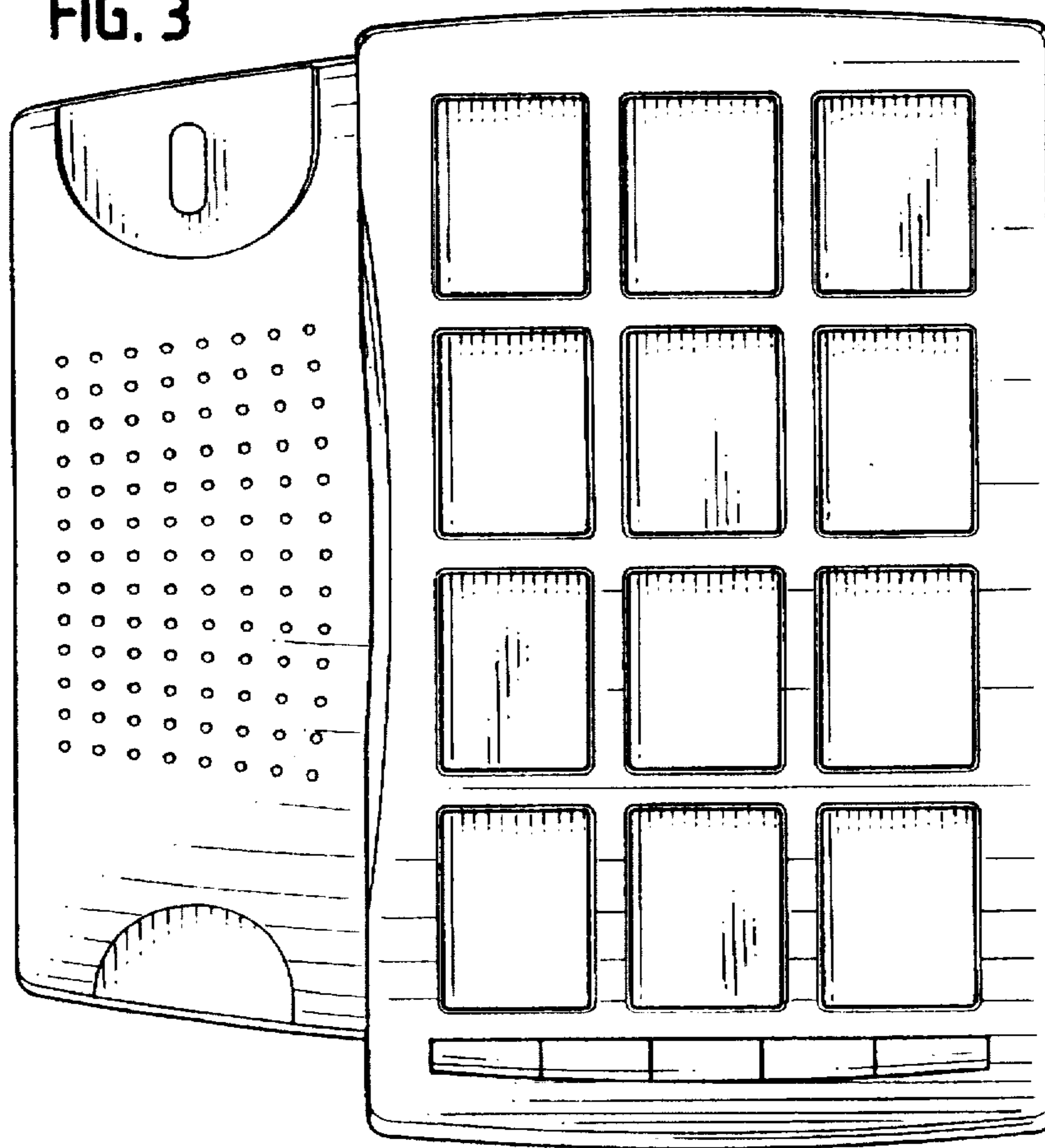

FIG. 4

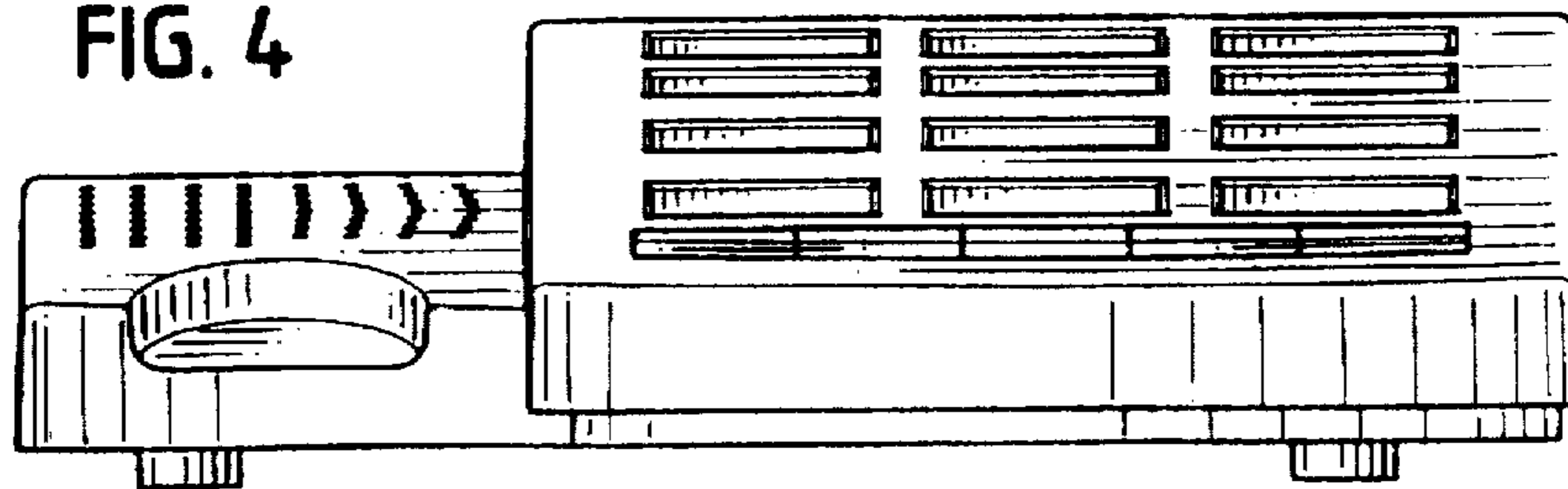

FIG. 5

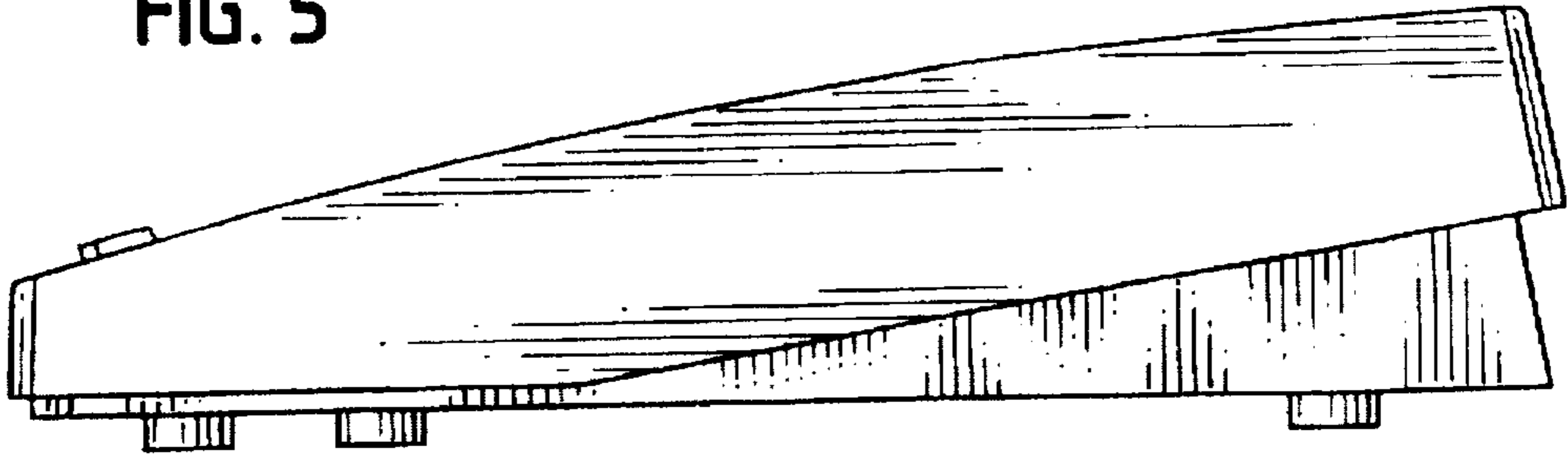

FIG. 6

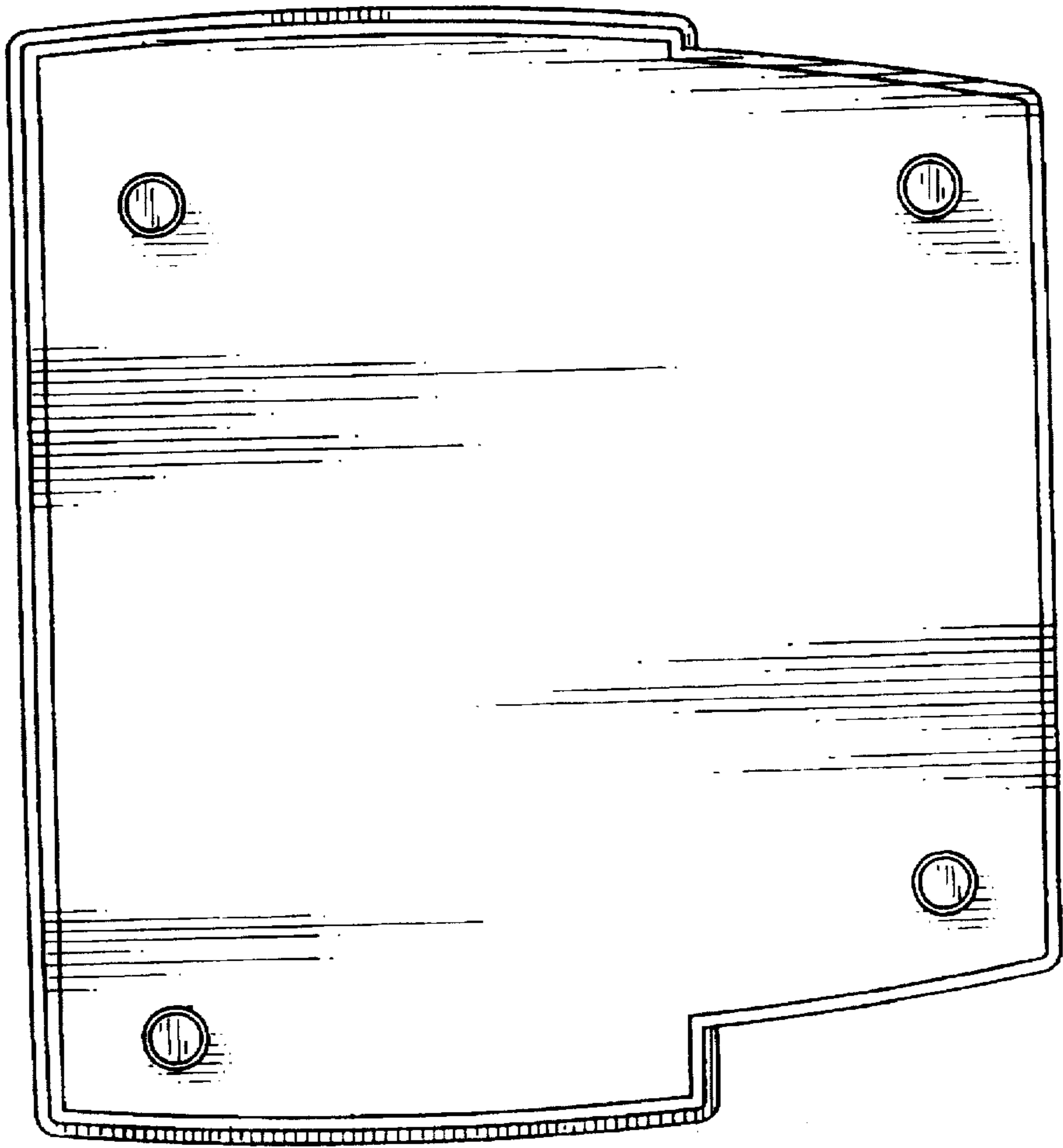

FIG. 7

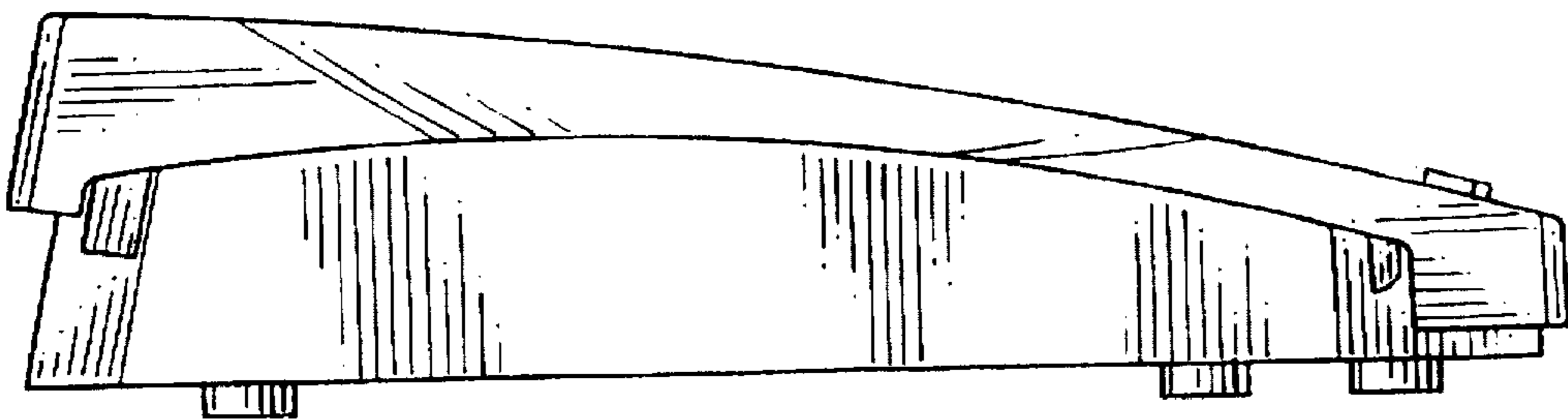

FIG. 8

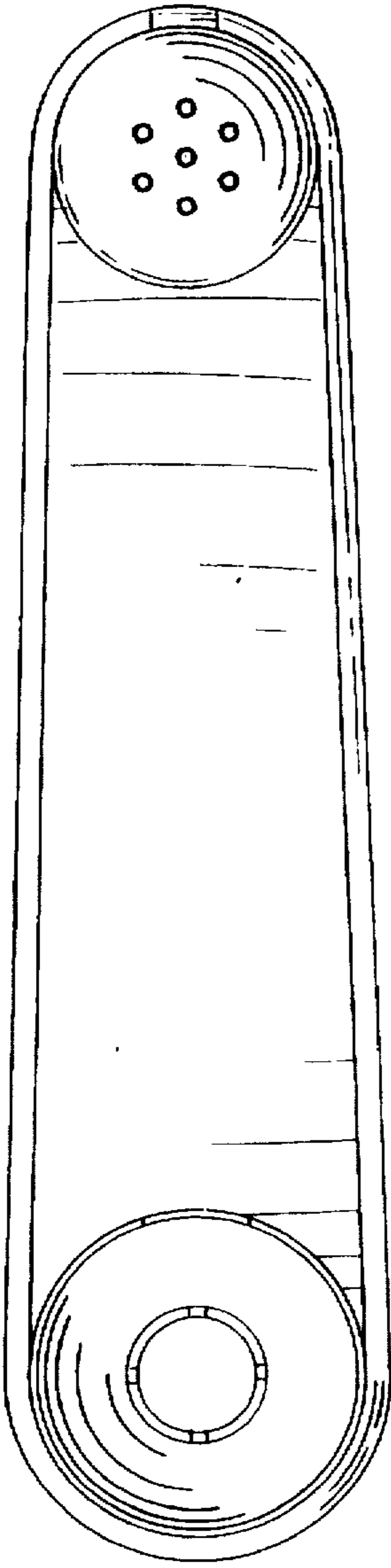

FIG. 9



FIG. 10

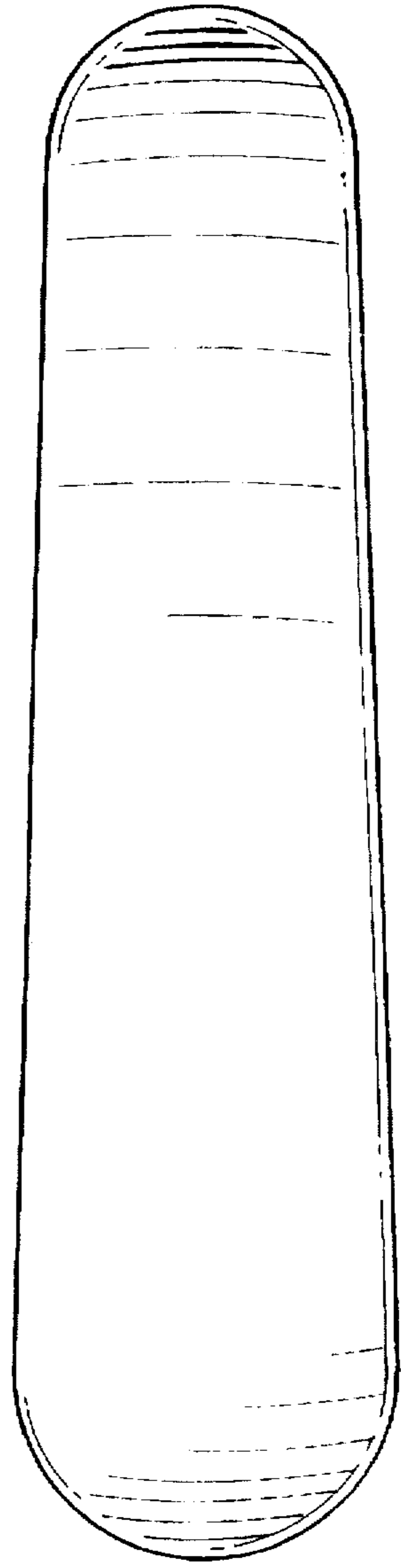

FIG. 11

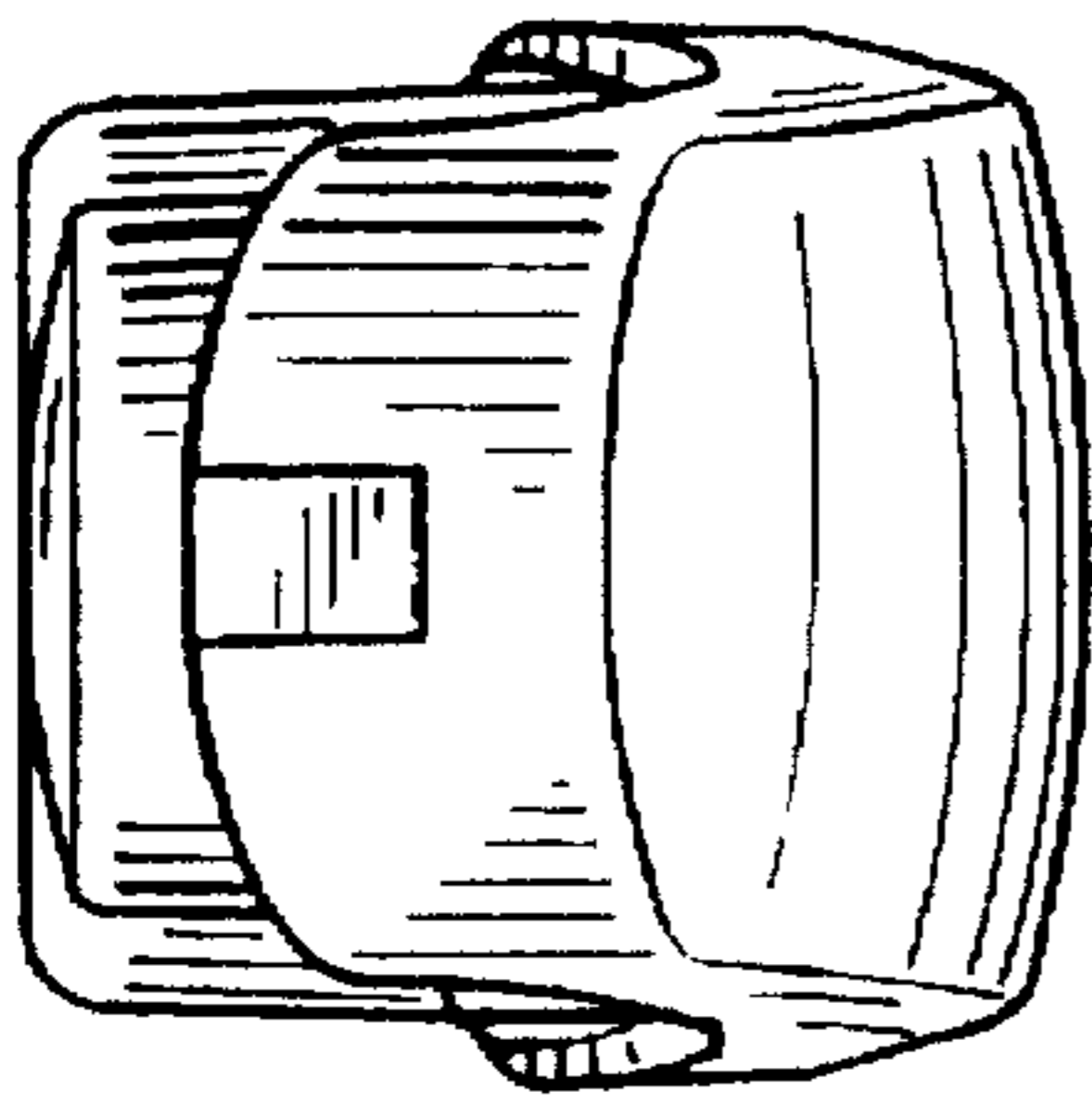

FIG. 12

