

US00D391942S

United States Patent [19]
Lee

[11] **Patent Number: Des. 391,942**

[45] **Date of Patent: **Mar. 10, 1998**

[54] **COMPUTER CASE**

[76] **Inventor: Chi Hsiu Lee, P.O. Box 82-144, Taipei, Taiwan**

[**] **Term: 14 Years**

[21] **Appl. No.: 61,304**

[22] **Filed: Nov. 21, 1996**

[51] **LOC (6) Cl. 14-02**

[52] **U.S. Cl. D14/114; D14/10**

[58] **Field of Search D14/100-114; D3/201, 212, 218; 206/312, 313, 307, 307.1; 361/683-686, 724-728**

[56] **References Cited**

U.S. PATENT DOCUMENTS

- D. 319,218 8/1991 Sakaguchi et al. D14/100
- D. 362,240 9/1995 Heidorn et al. D14/114

*Primary Examiner—Kay H. Chin
Attorney, Agent, or Firm—A & J*

[57] **CLAIM**

The ornamental design for a computer case, as shown and described.

DESCRIPTION

FIG. 1 is a perspective view of a computer case showing my new design;

FIG. 2 is a front view thereof;

FIG. 3 is a left side elevational view thereof;

FIG. 4 is a right side elevational view thereof;

FIG. 5 is a top plan view thereof;

FIG. 6 is a bottom plan view thereof; and,

FIG. 7 is a rear view thereof.

1 Claim, 4 Drawing Sheets

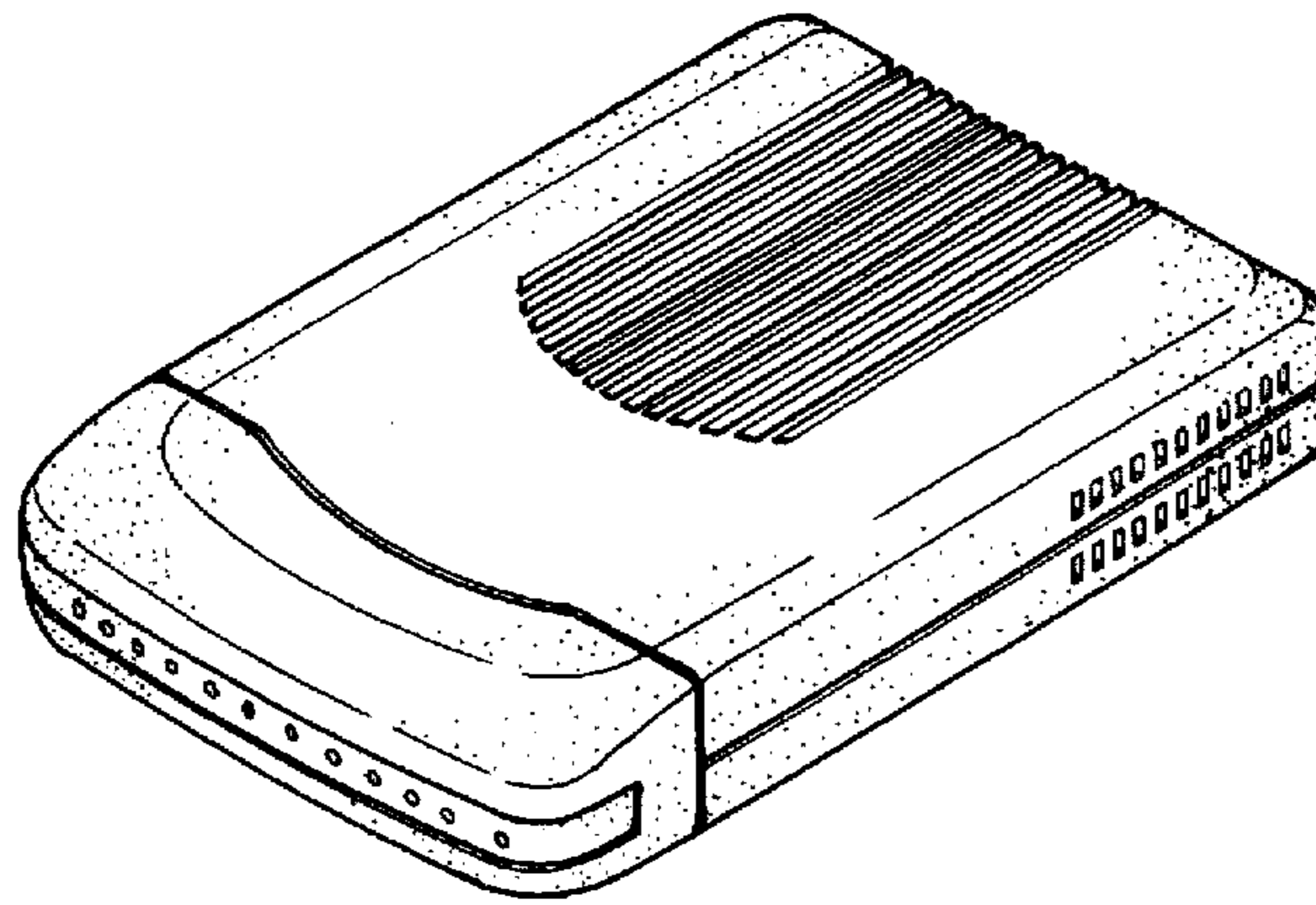

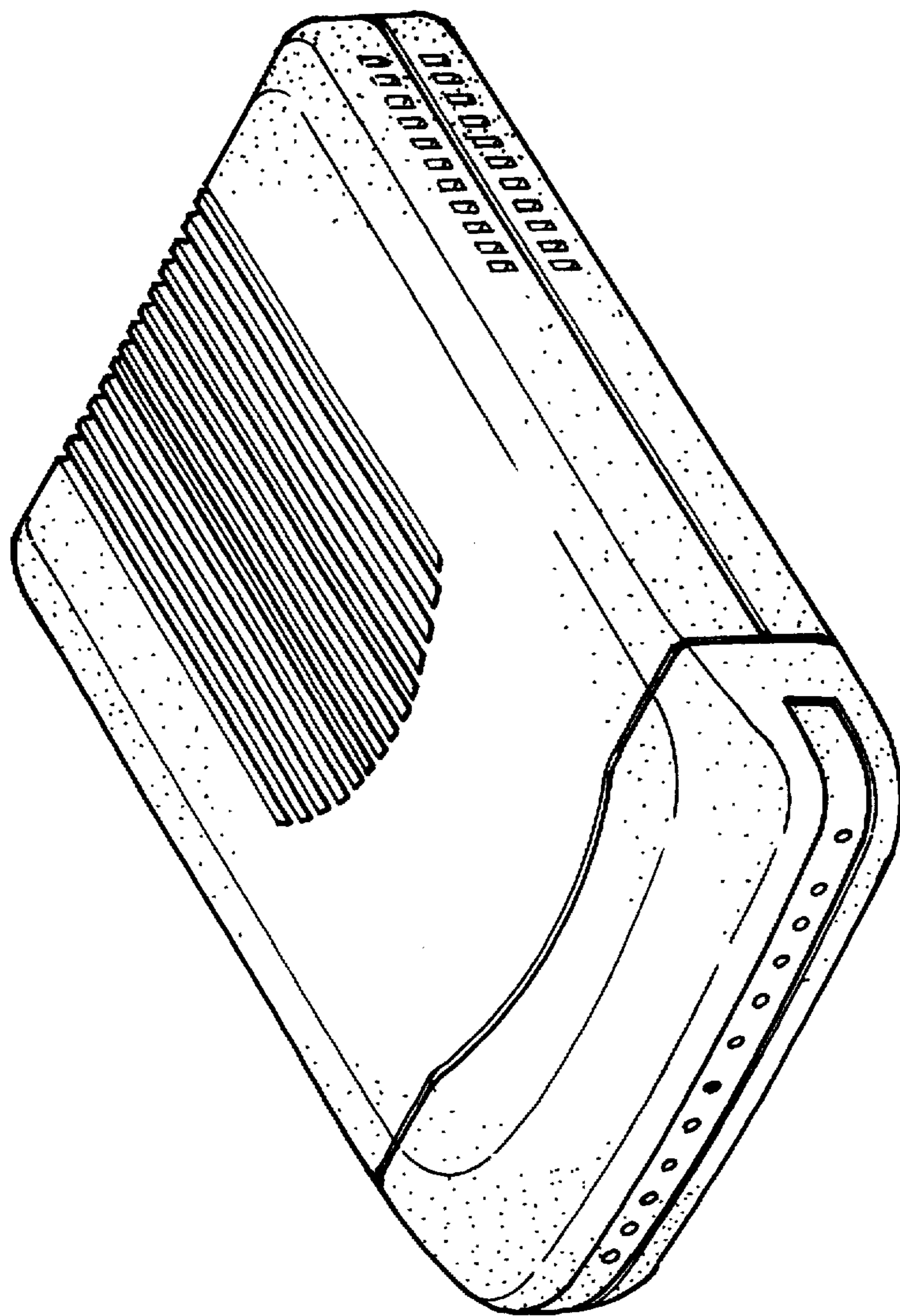

FIG. 1

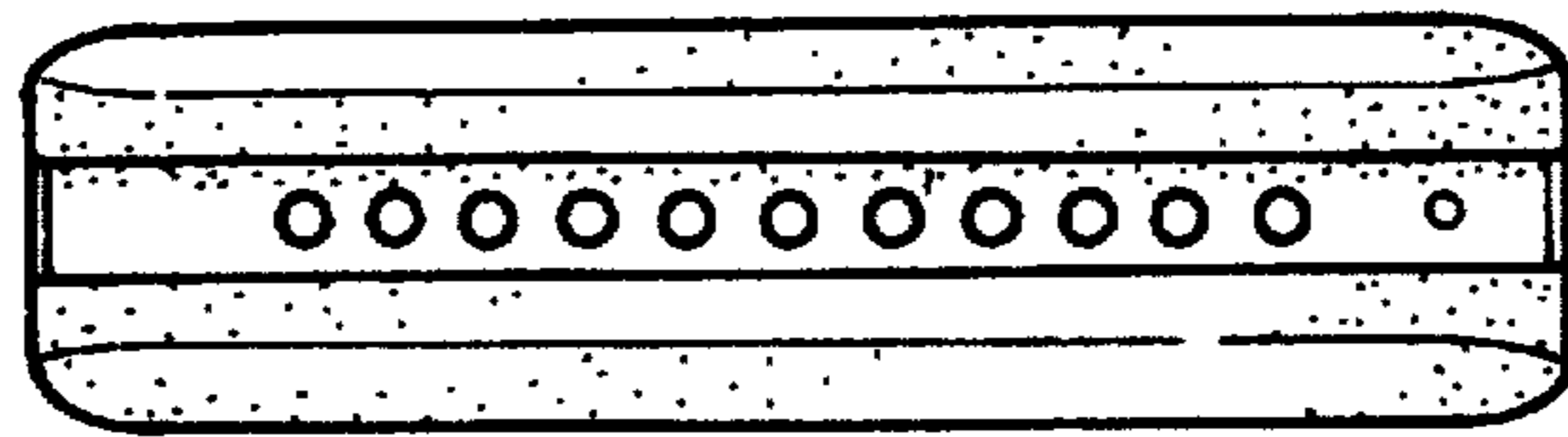

FIG. 2

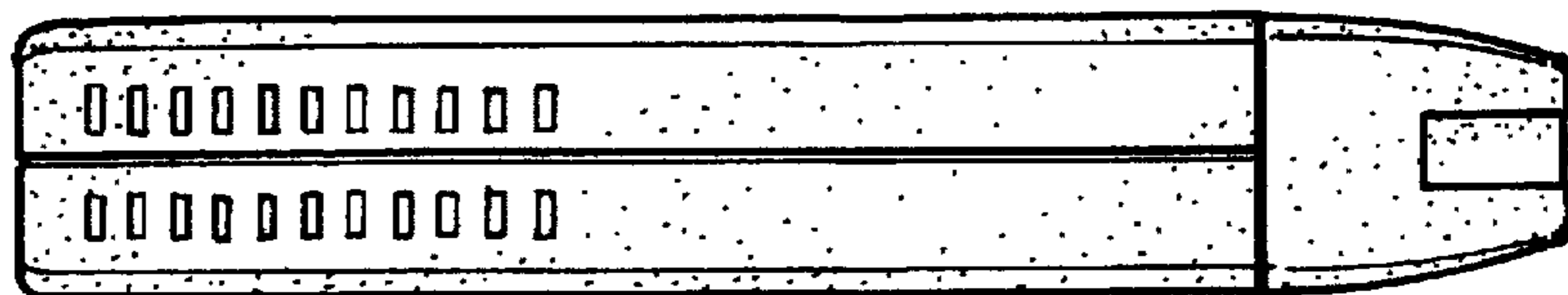

FIG. 3

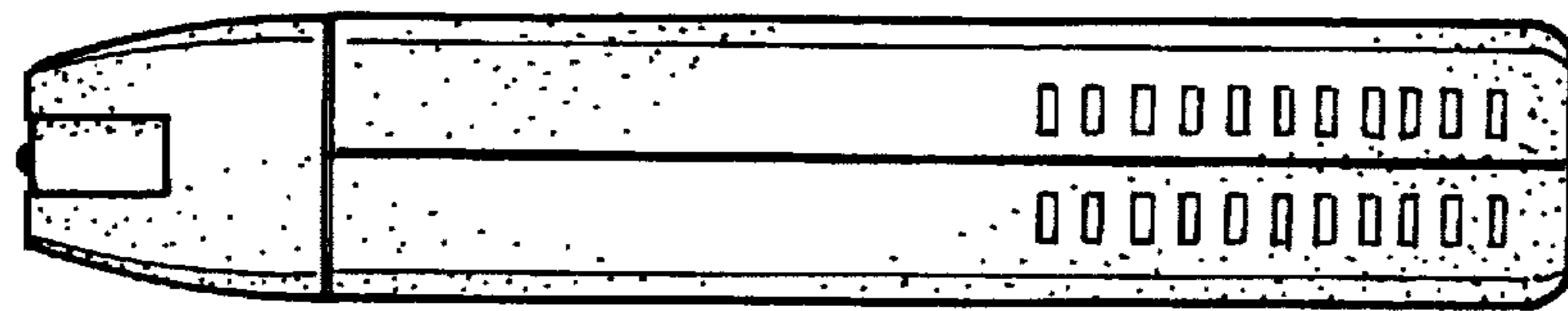

FIG. 4

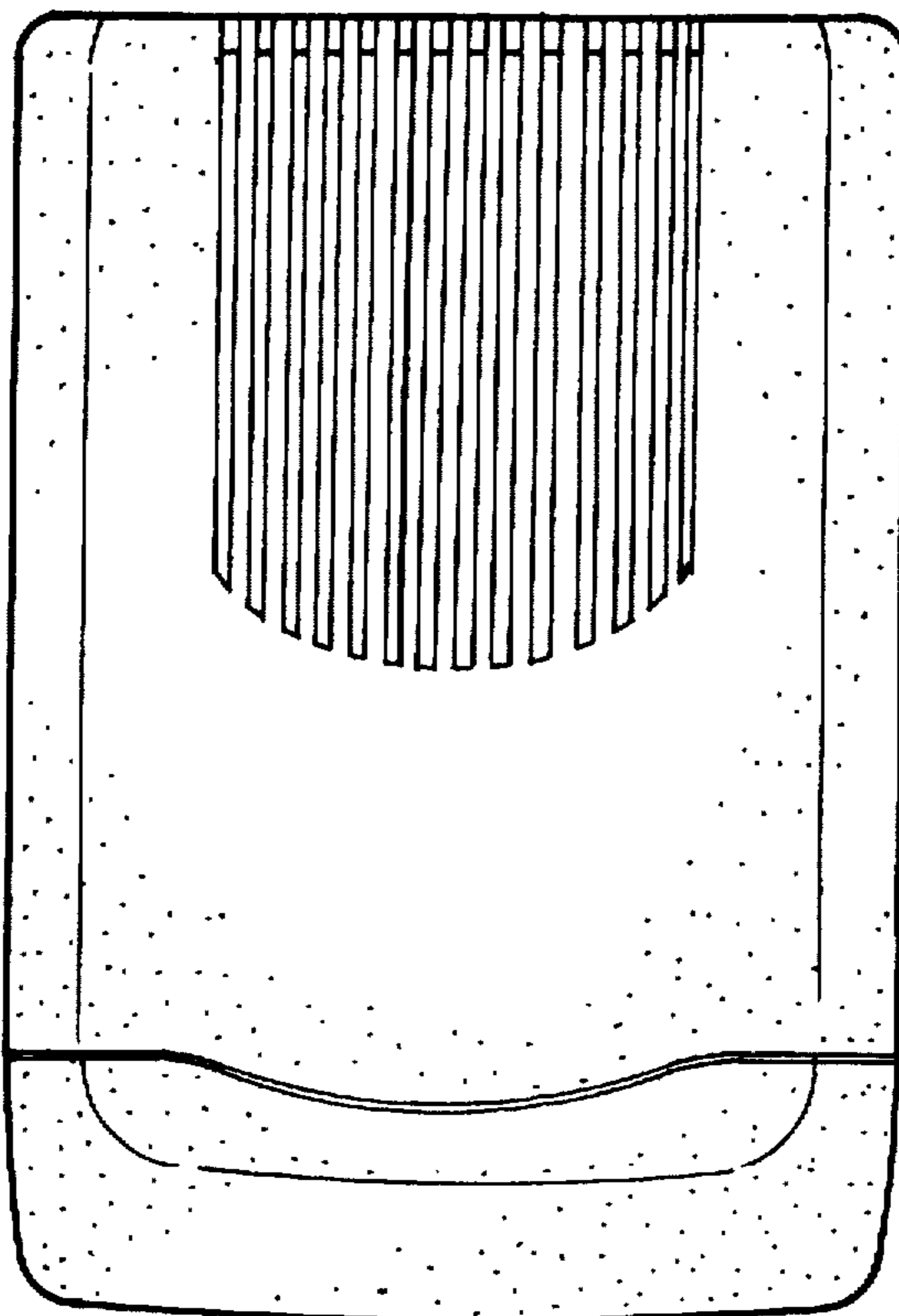

FIG. 5



FIG. 6

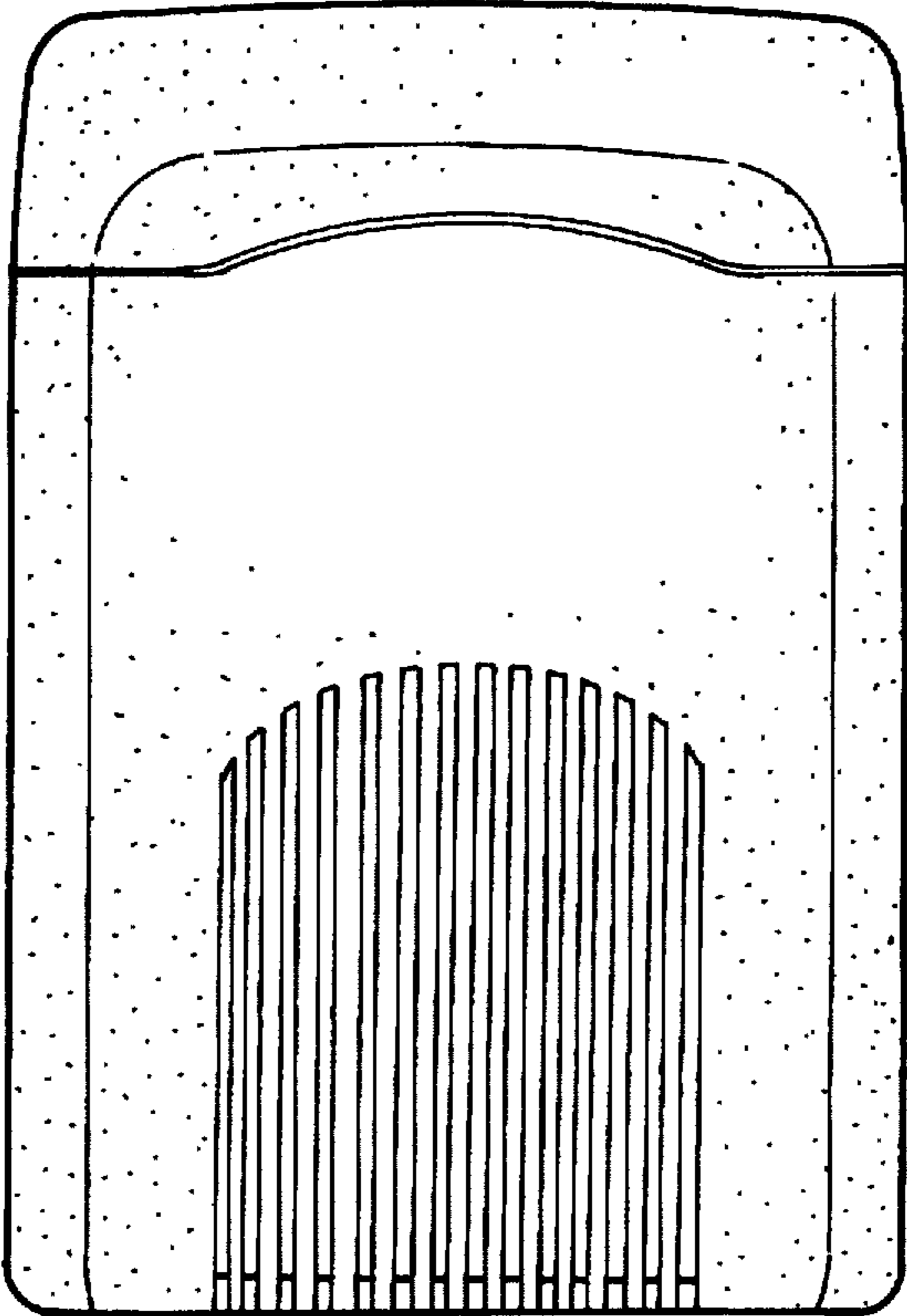

FIG. 7