



US00D391847S

United States Patent [19]

Seo et al.

[11] Patent Number: Des. 391,847

[45] Date of Patent: **Mar. 10, 1998

[54] **CARTON WITH HANDLE**

[76] Inventors: **Sang Yeul Seo**, Hyosungtown 109-903, Bongduck-dong, Nam-ku, Daegu 705-020; **Han Boong Gwak**, 1362-6, Beommul-dong, Soosung-ku, Daegu 706-010, both of Rep. of Korea

[**] Term: **14 Years**

[21] Appl. No.: **64,284**

[22] Filed: **Dec. 26, 1996**

[30] **Foreign Application Priority Data**

Aug. 17, 1996 [KR] Rep. of Korea 1996-17411

[51] **LOC (6) Cl.** **07-09**

[52] **U.S. Cl.** **D9/417; D9/418; D9/432**

[58] **Field of Search** **D9/414, 415, 418, D9/417, 432, 416; 229/125.42, 117.12, 116.1, 117.09, 162, 915.1, 918**

[56] **References Cited**

U.S. PATENT DOCUMENTS

D. 183,567 9/1958 Hagan D9/432

D. 183,717 10/1958 Casler D9/432
2,050,894 8/1936 Paige 229/116.1
3,390,828 7/1968 Malby et al. 229/117.12
4,313,556 2/1982 Boyle et al. 229/116.1
4,846,396 7/1989 Palazzolo 229/117.12
5,000,375 3/1991 Farber et al. 229/117.12

Primary Examiner—Prabhakar G. Deshmukh
Attorney, Agent, or Firm—Morrison Law Firm

[57] **CLAIM**

The ornamental design for a carton with handle, as shown and described.

DESCRIPTION

FIG. 1 is a perspective view of a carton with handle showing our new design;
FIG. 2 is a front elevational view thereof; the rear elevational view being a mirror image thereof;
FIG. 3 is a left side elevational view thereof; the right side elevational view being a mirror image thereof;
FIG. 4 is a top plan view thereof;
FIG. 5 is a bottom plan view thereof; and,
FIG. 6 is a sectional plan view thereof; taken along line 6—6 of FIG. 2.

1 Claim, 3 Drawing Sheets

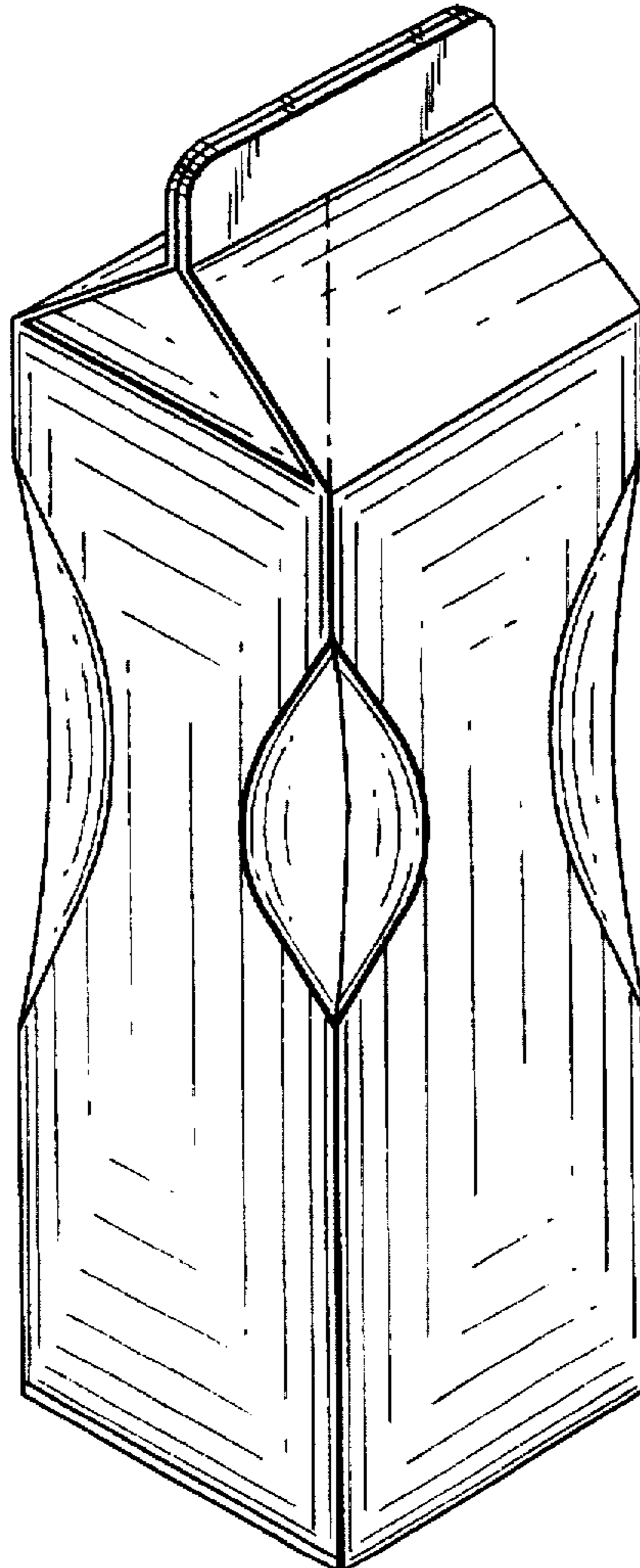

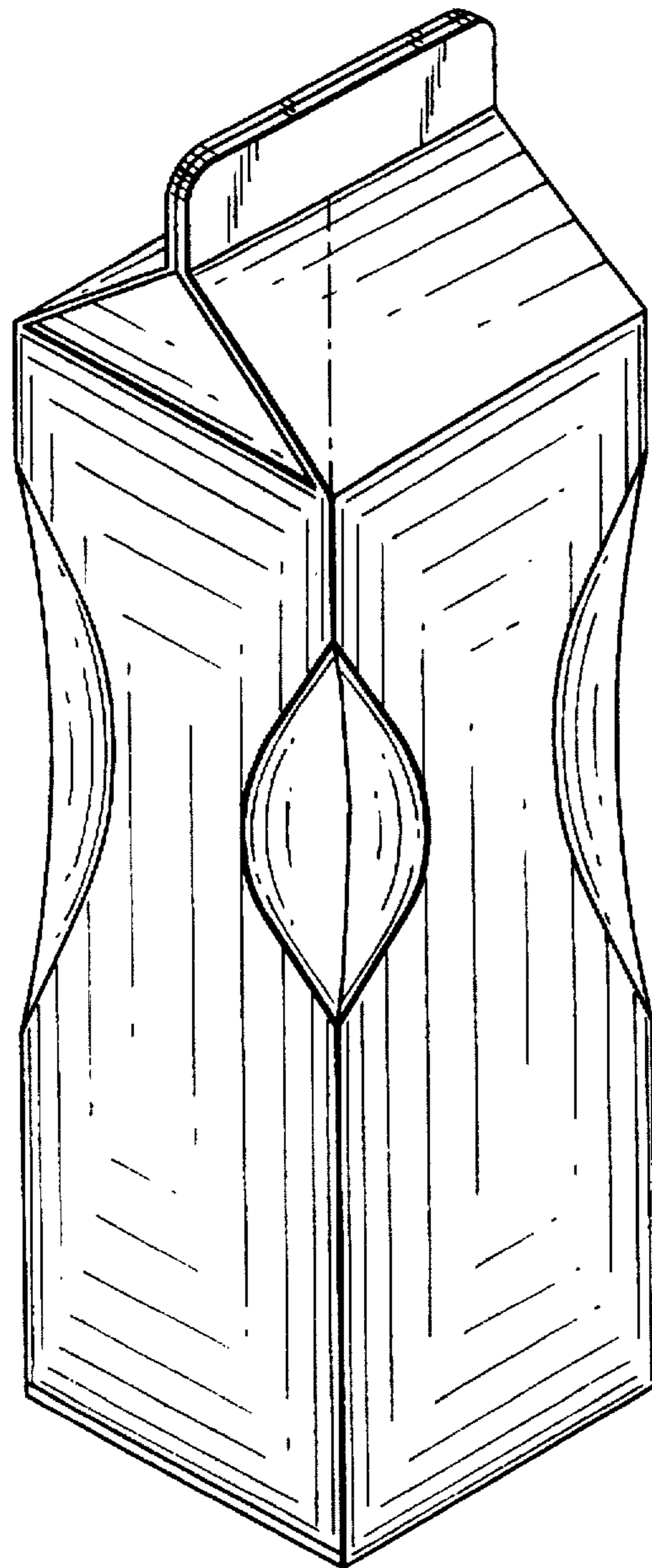

FIG. 1

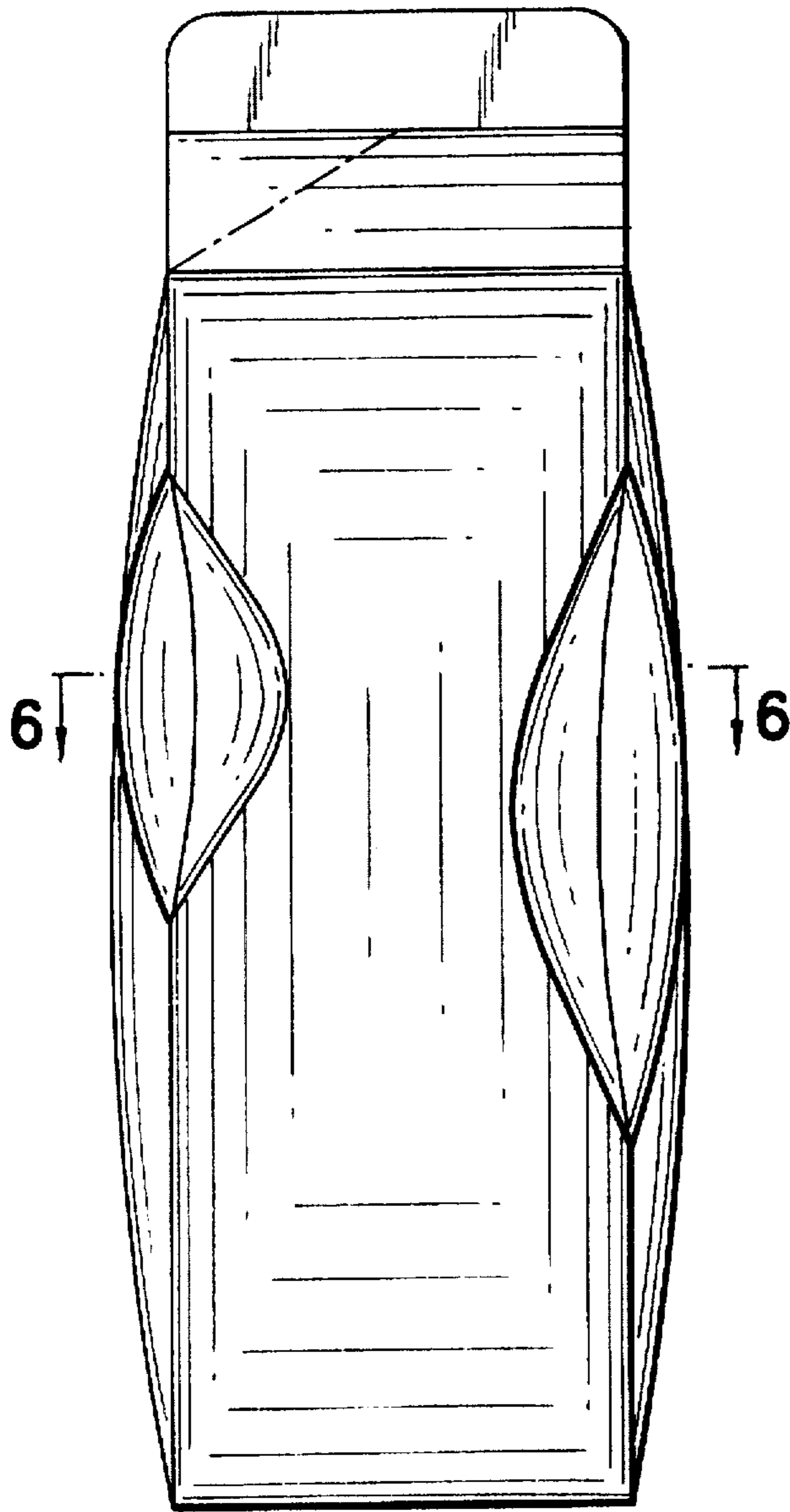

FIG. 2

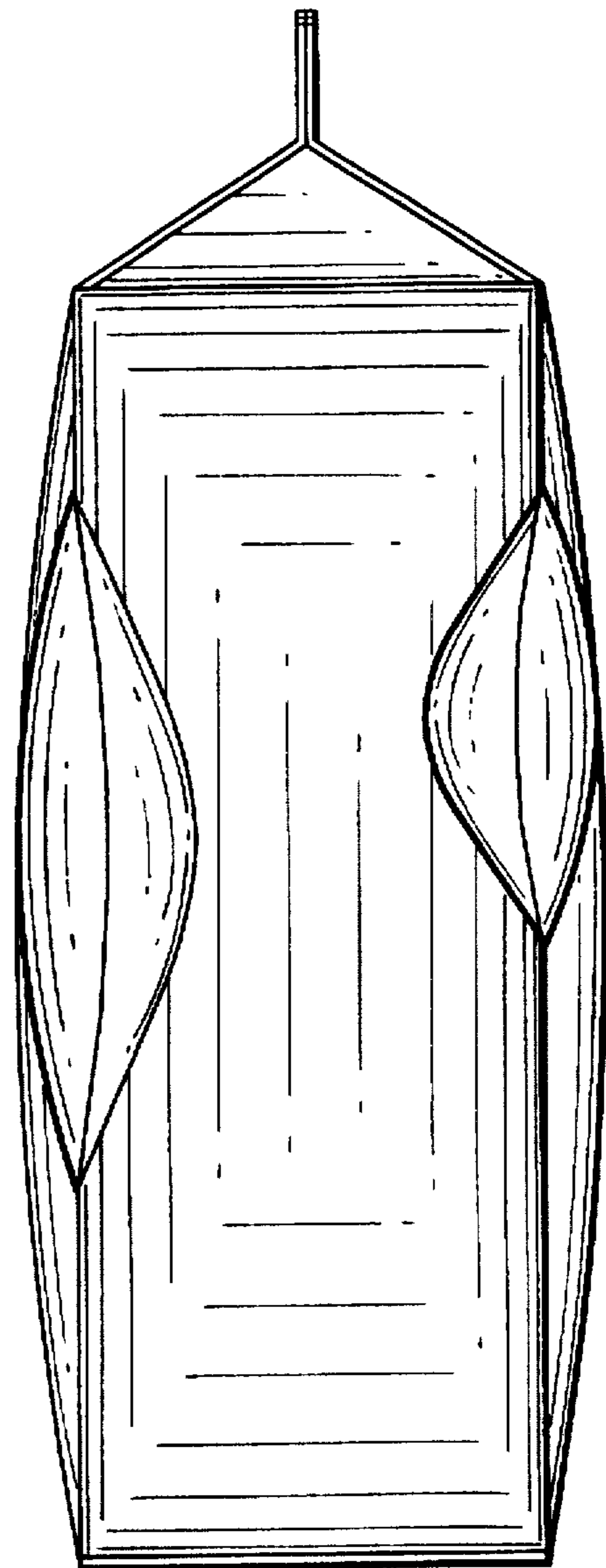

FIG. 3

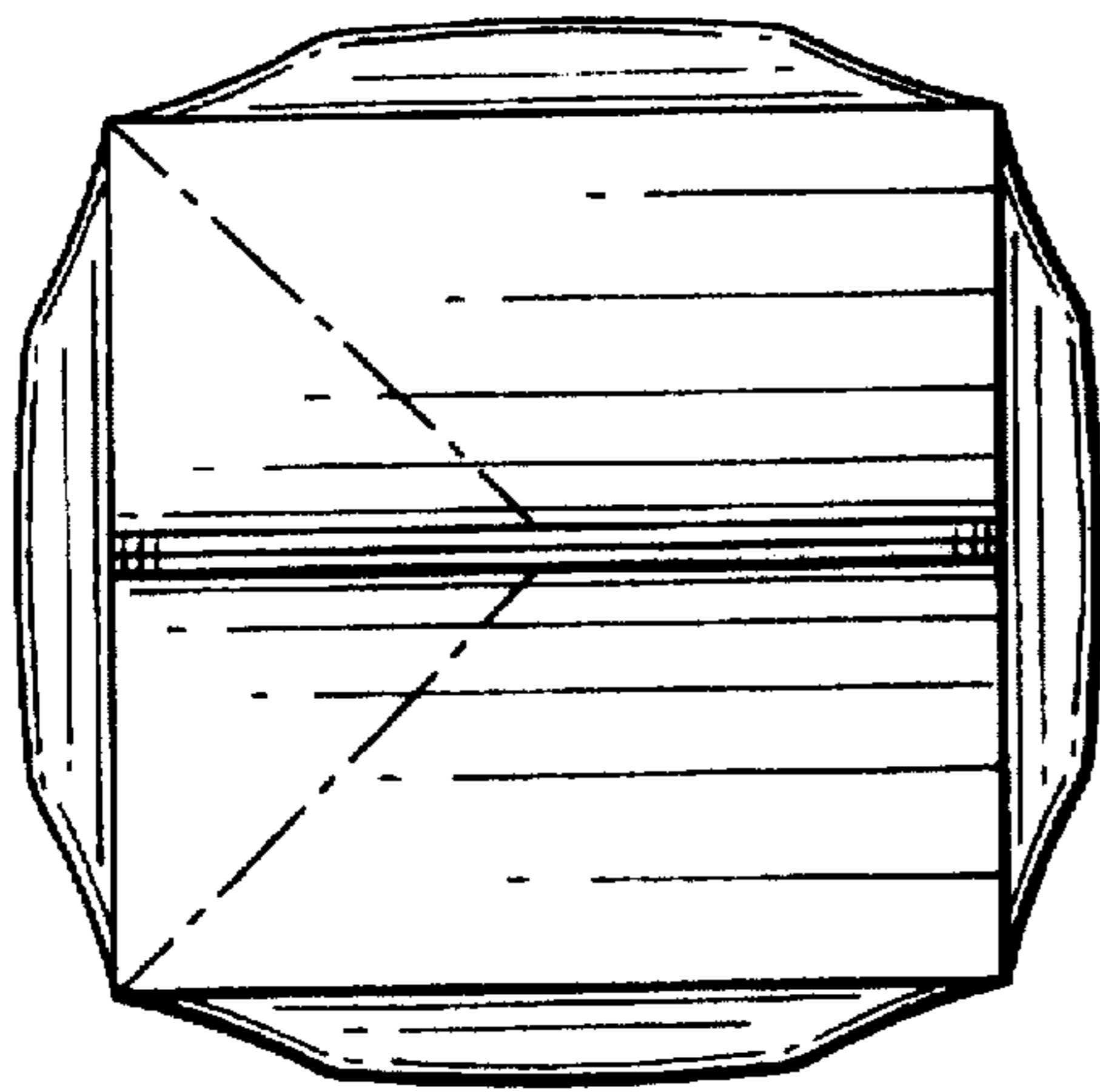

FIG. 4

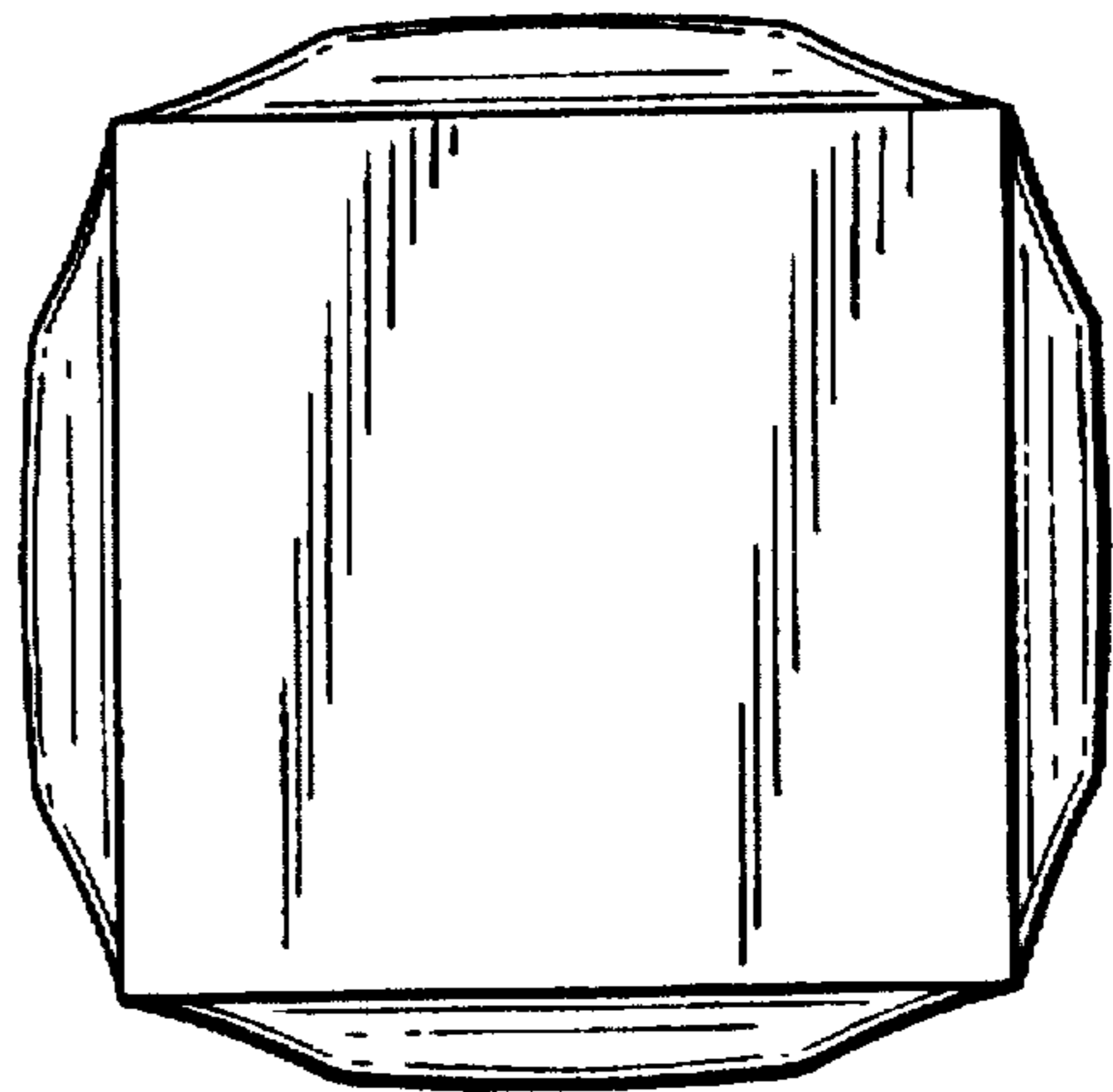

FIG. 5

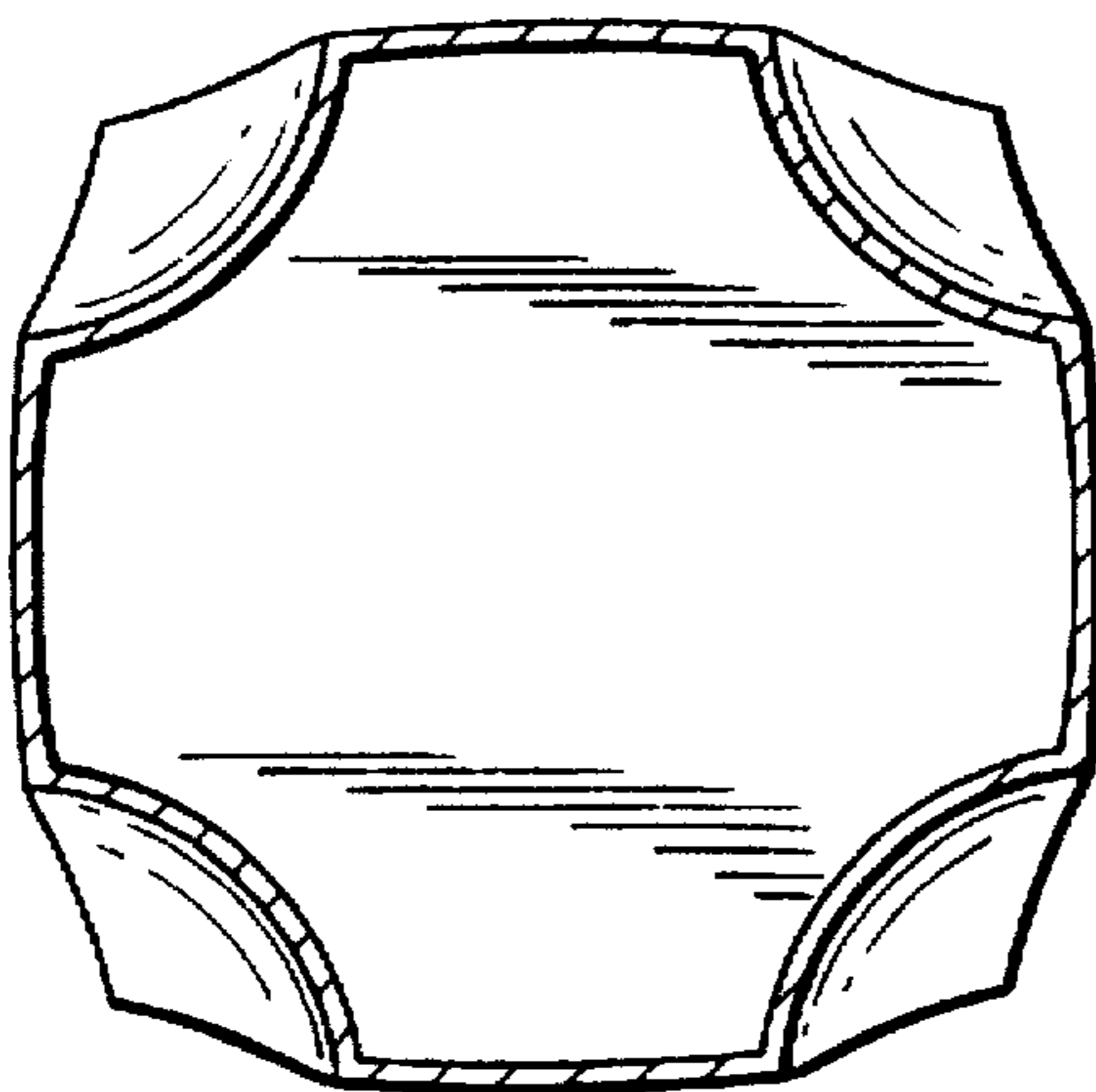

FIG. 6