

US00D391810S

**United States Patent** [19]  
**Cooper**

[11] **Patent Number: Des. 391,810**  
[45] **Date of Patent: \*\*Mar. 10, 1998**

[54] **COMBINED GUM AND MINT CONTAINER**

[76] **Inventor: Susanna Cooper, 1034 Meadowlawn, Pontiac, Mich. 48340**

[\*\*] **Term: 14 Years**

[21] **Appl. No.: 72,350**

[22] **Filed: Jun. 13, 1997**

[51] **LOC (6) Cl. .... 07-01**

[52] **U.S. Cl. .... D7/629; D3/208**

[58] **Field of Search .... D7/601, 629; D3/207, D3/208; 206/37.8, 38, 38.1, 39.7, 216, 800**

[56] **References Cited**

**U.S. PATENT DOCUMENTS**

5,439,104 8/1995 Wolska-Klis ..... 206/38  
5,636,732 6/1997 Gilels ..... 206/800 X

*Primary Examiner—Terry A. Wallace  
Attorney, Agent, or Firm—David L. Volk*

[57] **CLAIM**

The ornamental design for a combined gum and mint container, as shown and described.

**DESCRIPTION**

FIG. 1 is a perspective view of a combined gum and mint container showing my new design;

FIG. 2 is a cross-section taken along line 2—2 of FIG. 1;

FIG. 3 is a right side elevational view thereof;

FIG. 4 is a top plan view thereof;

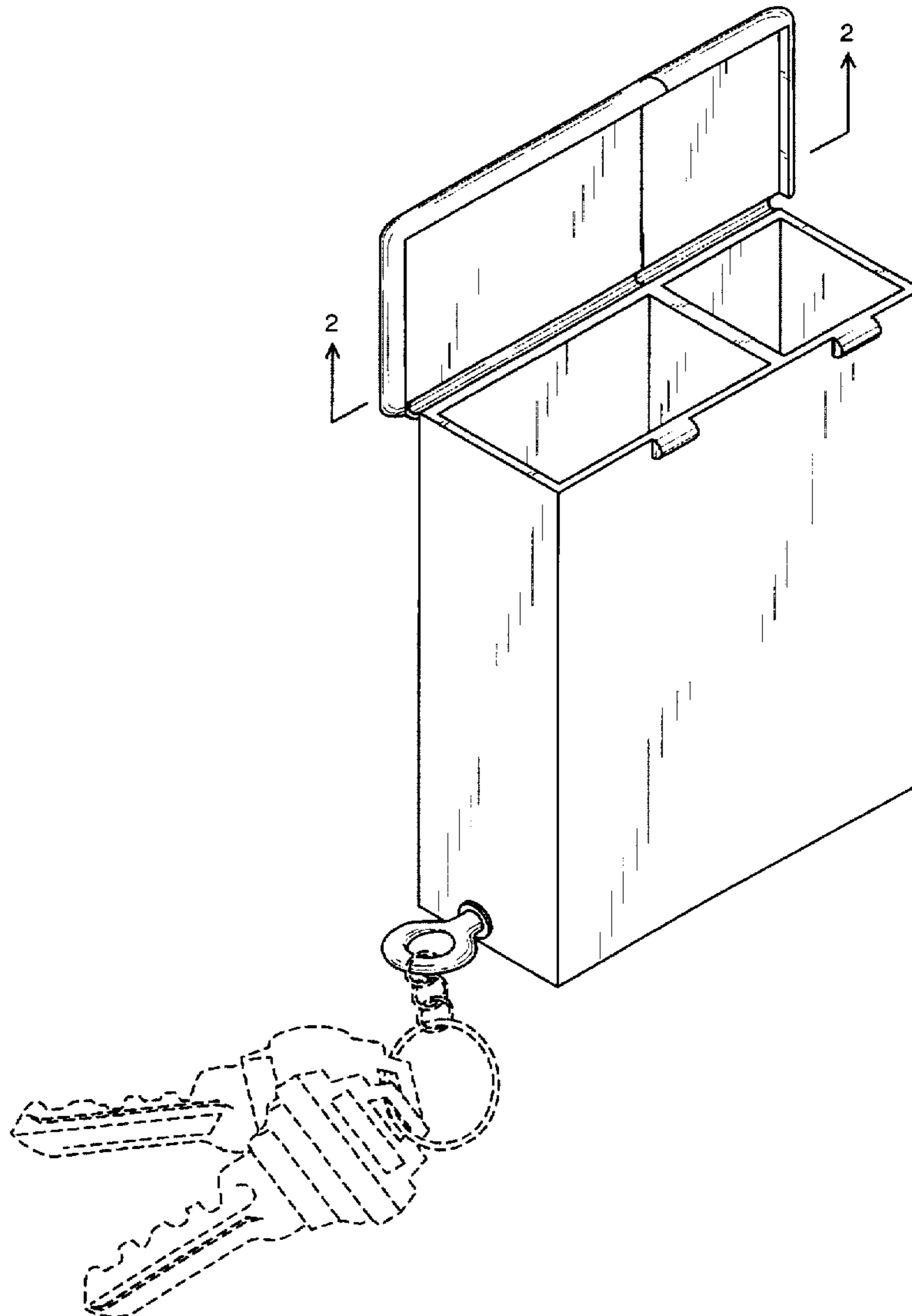
FIG. 5 is a bottom plan view thereof;

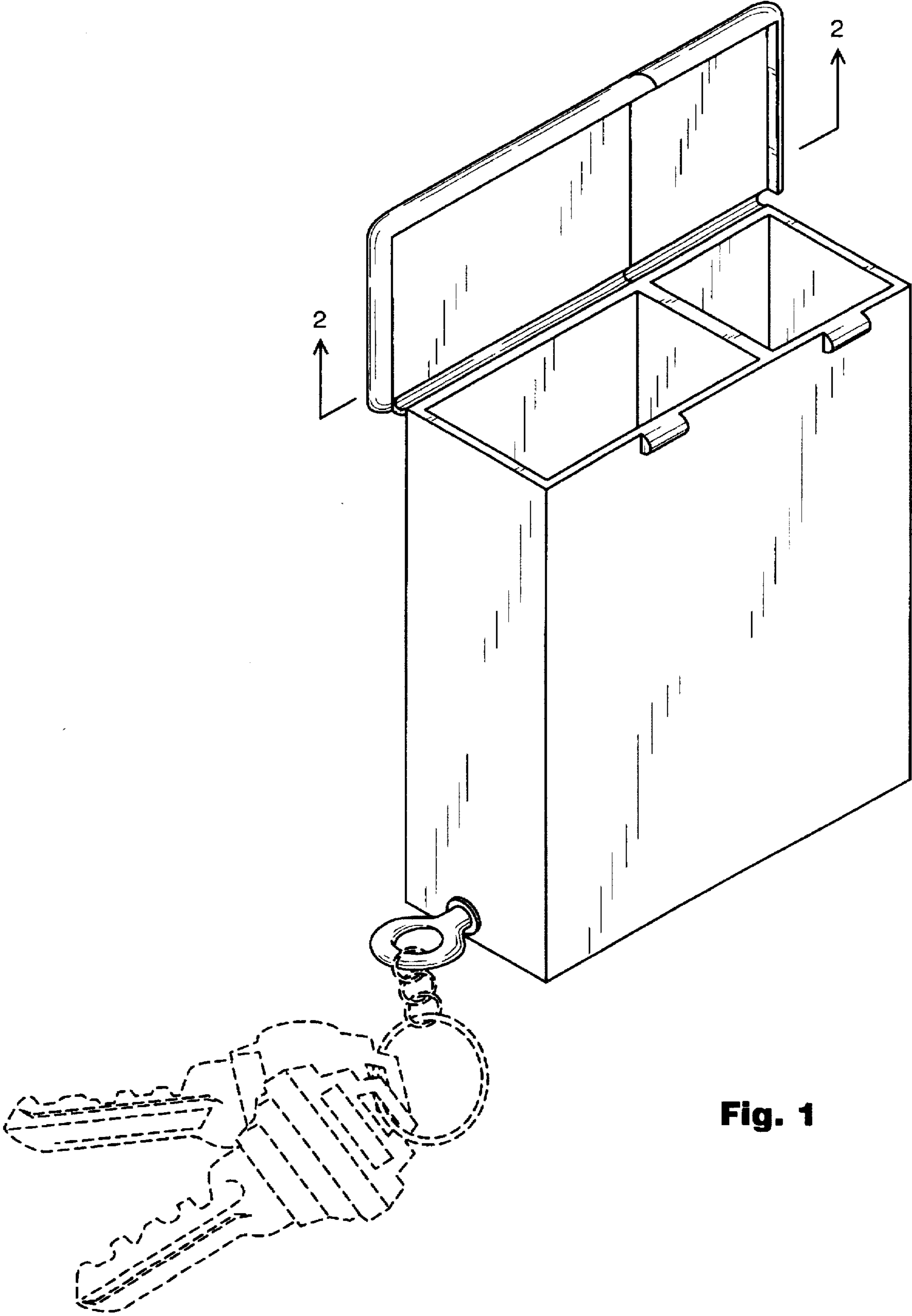
FIG. 6 is a rear elevational view thereof; and,

FIG. 7 is a perspective view thereof, shown with one of the lids closed.

The broken line illustration shows environmental structure and forms no part of the claimed invention. Undisclosed and partially disclosed surfaces are plain and unornamented.

**1 Claim, 5 Drawing Sheets**

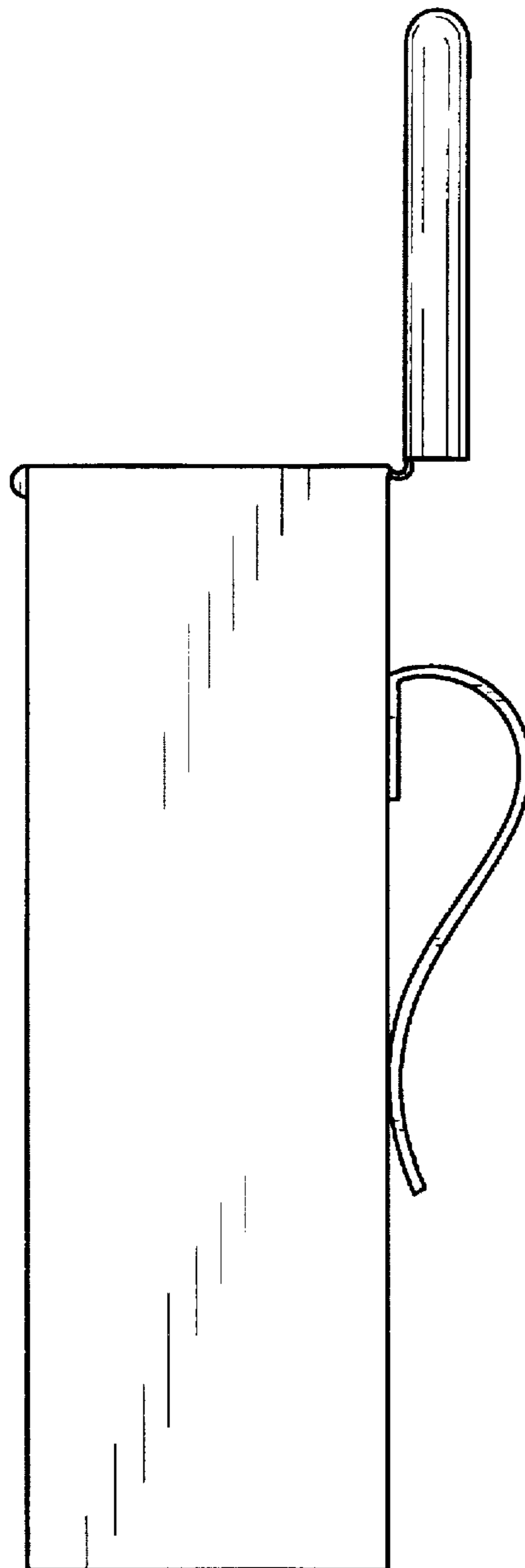




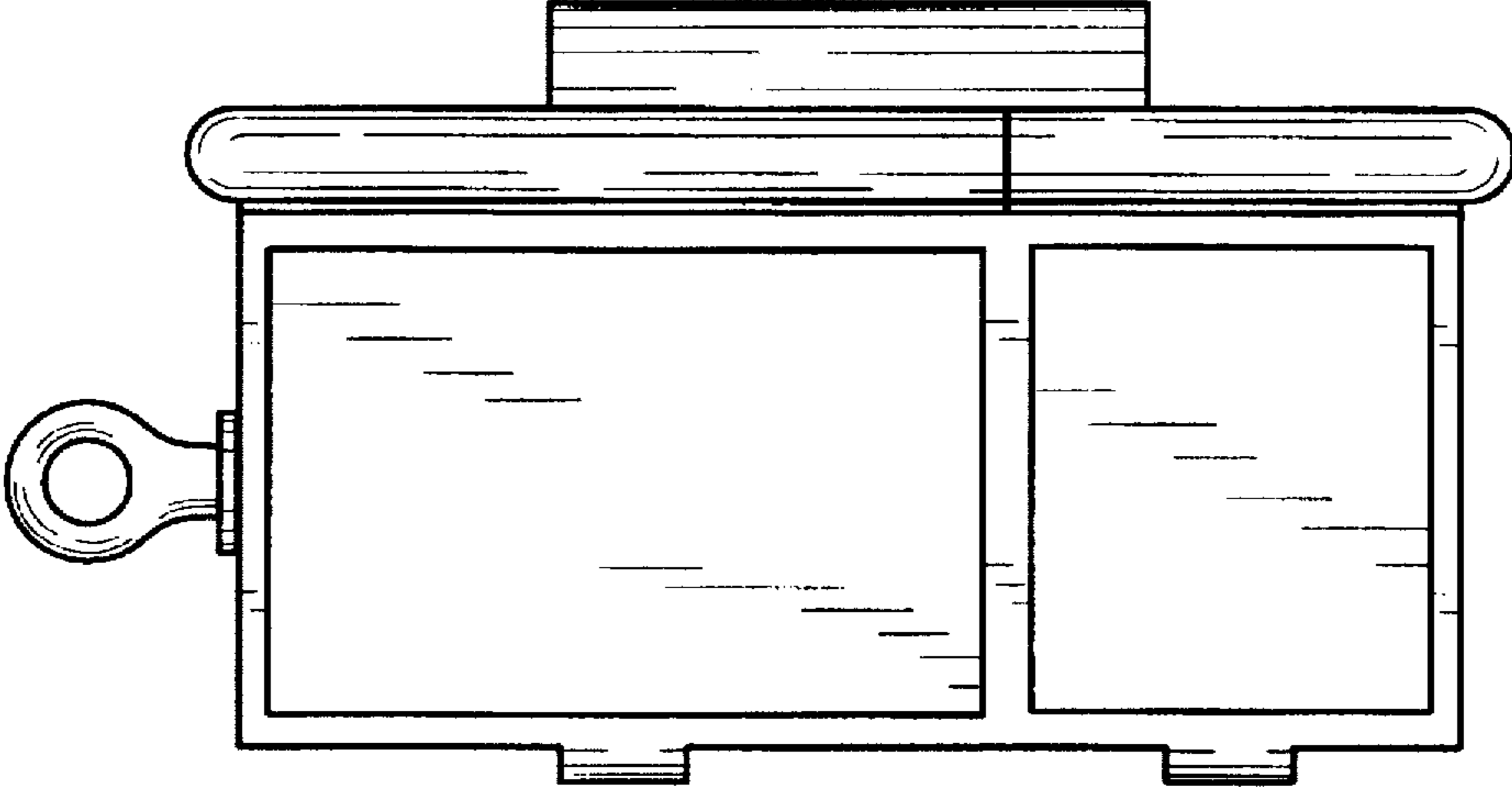
**Fig. 1**



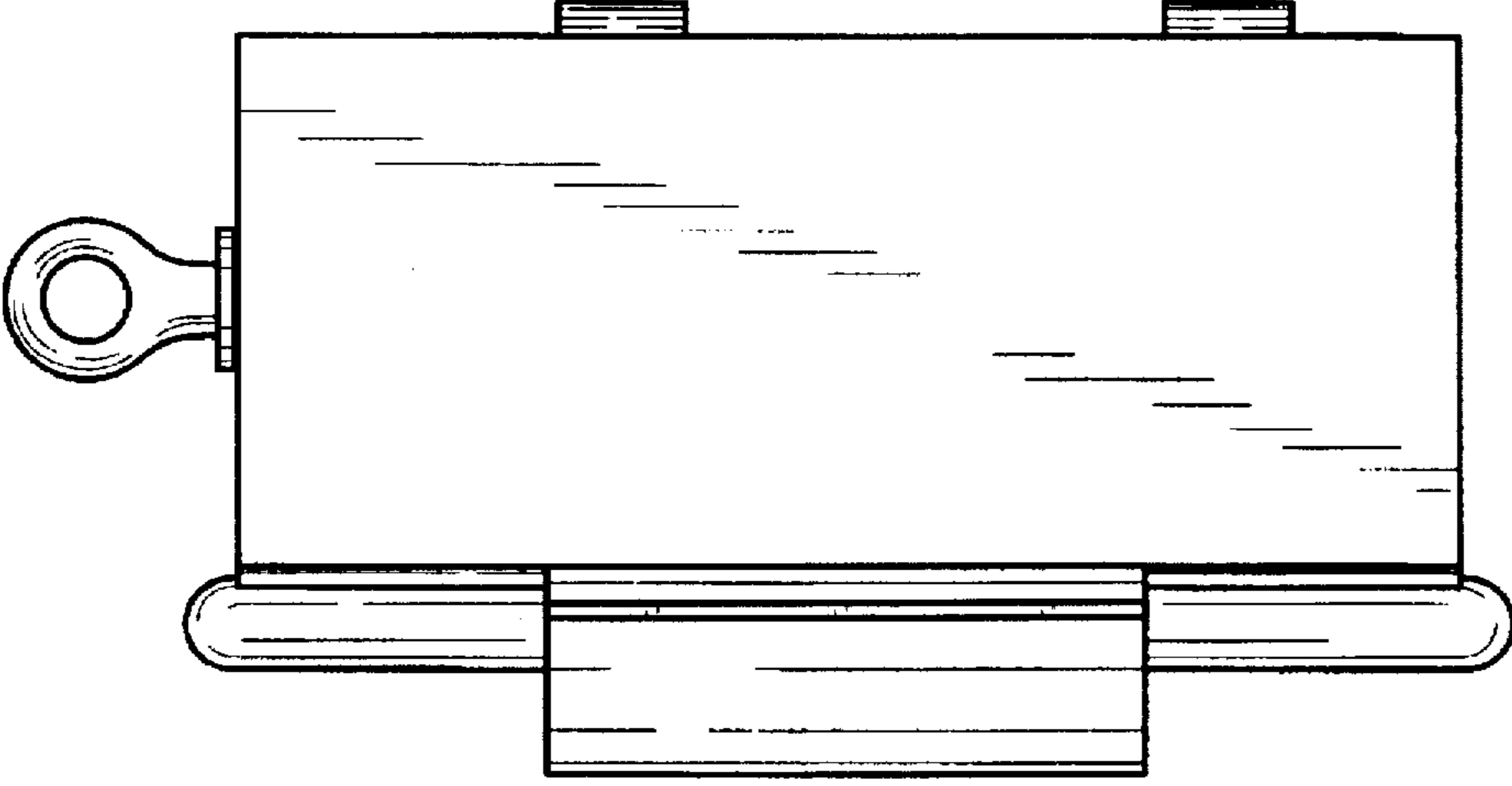
**Fig. 2**



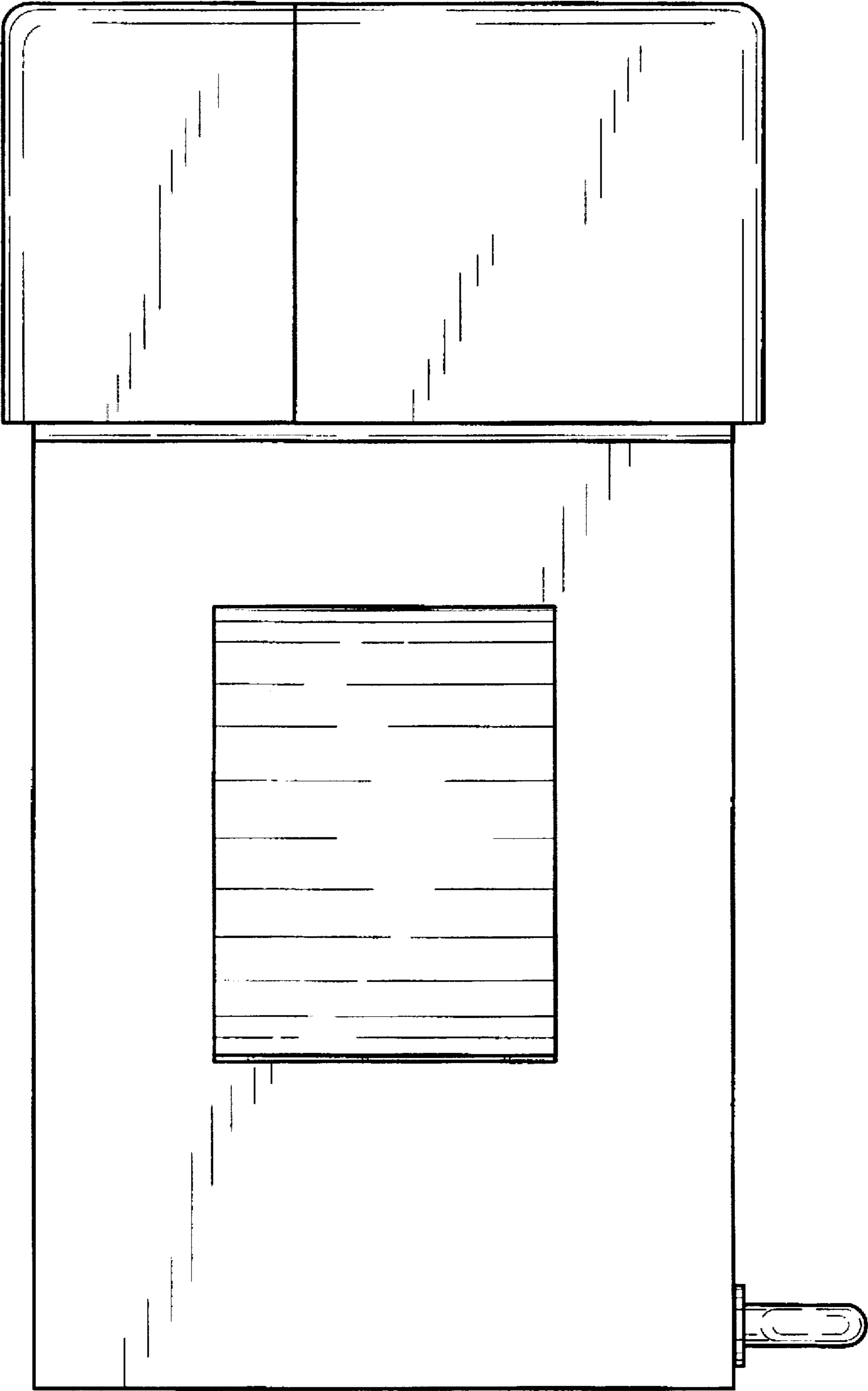
**Fig. 3**



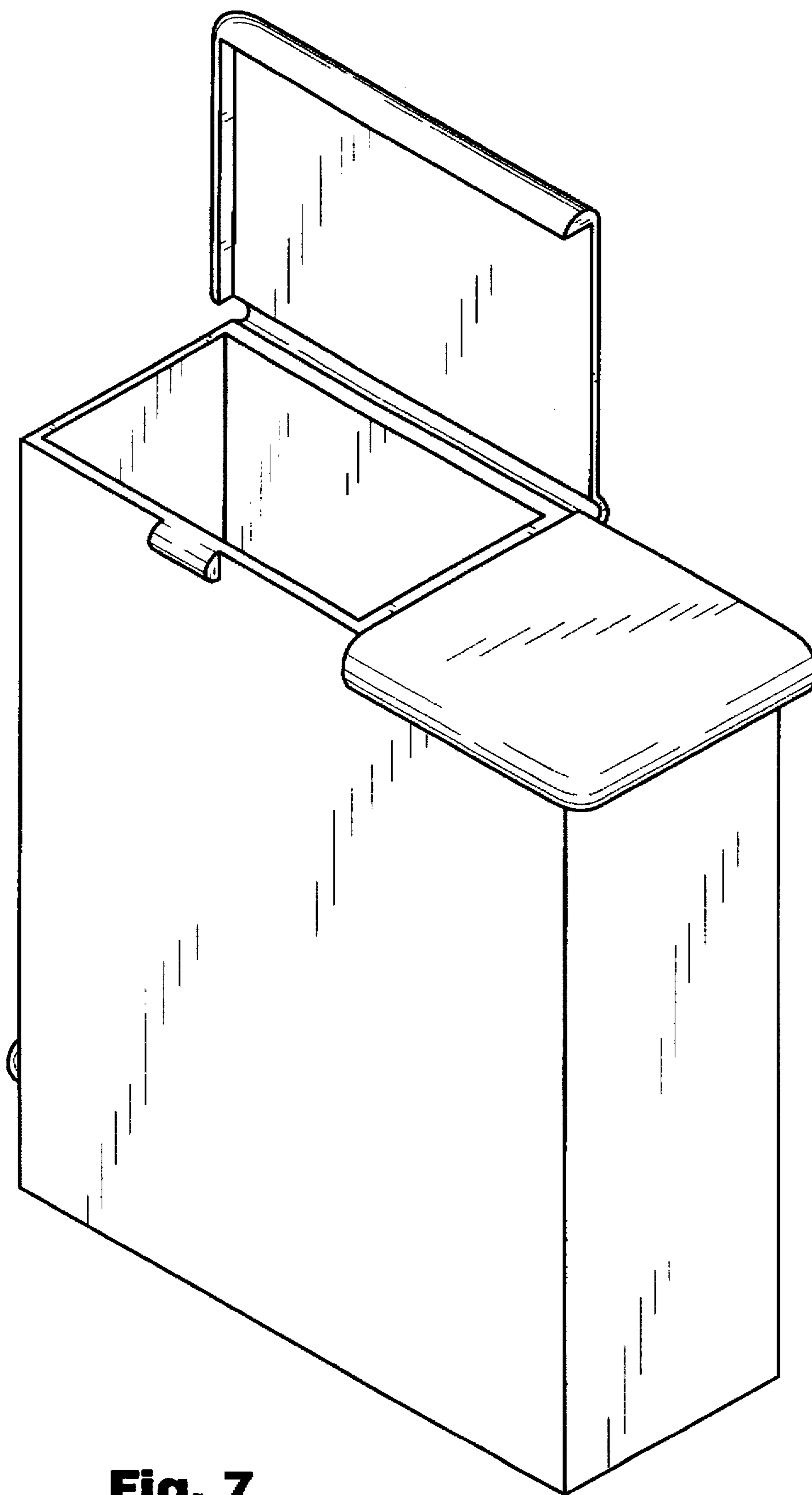
**Fig. 4**



**Fig. 5**



**Fig. 6**



**Fig. 7**