



US00D391702S

United States Patent [19]

Wareham et al.

[11] Patent Number: **Des. 391,702**

[45] Date of Patent: ****Mar. 3, 1998**

[54] **VACUUM CLEANER UPPER PORTION**

[75] Inventors: **Richard A. Wareham; David W. Moine**, both of North Canton, Ohio

[73] Assignee: **The Hoover Company**, North Canton, Ohio

[**] Term: **14 Years**

[21] Appl. No.: **64,767**

[22] Filed: **Jan. 10, 1997**

[51] **LOC (6) Cl.** **15-05**

[52] **U.S. Cl.** **D32/31**

[58] **Field of Search** D32/21, 22, 31-34;
15/320-322, 329, 335, 347, 350-353, 410,
412, 414

[56] **References Cited**

U.S. PATENT DOCUMENTS

D. 198,436	6/1964	Gantz .	
D. 234,334	2/1975	Mims	D7/165
D. 277,325	1/1985	Hug	D32/24
D. 278,560	4/1985	Wareham	D32/22
D. 286,334	10/1986	Strohmeier	D32/22
D. 286,335	10/1986	Strohmeier	D32/22
D. 314,260	1/1991	Lee	D32/22
D. 319,517	8/1991	Sovis et al.	D32/22
D. 335,556	5/1993	Kuriya	D32/22
D. 339,435	9/1993	McKnight et al.	D32/31
D. 344,821	3/1994	McKnight	D32/31
D. 346,053	4/1994	Hoshino	D32/31
D. 346,469	4/1994	Furcron et al.	D32/22

D. 347,500	5/1994	Abe et al.	D32/22
D. 354,379	1/1995	Shinozaki	D32/22
D. 357,096	4/1995	Wareham	D32/31
D. 358,236	5/1995	Kupco et al.	D32/22
D. 358,913	5/1995	Sugiyama et al.	D32/22
D. 371,652	7/1996	Umbach	D32/22
D. 375,594	11/1996	Luebbering	D32/22
D. 379,254	5/1997	Roberts et al.	D32/31

FOREIGN PATENT DOCUMENTS

71782	10/1992	Canada .
76267	4/1995	Canada .

OTHER PUBLICATIONS

Bissell® Plus™ Hard Bag Cleaner, Model 3550.

Primary Examiner—Ruth McInroy

Attorney, Agent, or Firm—A. Burgess Lowe; Richardson B. Farley

[57] **CLAIM**

The ornamental design of a vacuum cleaner upper portion, as shown and described.

DESCRIPTION

FIG. 1 is a front elevational view of a vacuum cleaner upper portion showing our new design; FIG. 2 is a rear side elevational view thereof; FIG. 3 is a left side elevational view thereof; FIG. 4 is a right side elevational view thereof; FIG. 5 is a top plan view thereof; and FIG. 6 is a bottom plan view thereof.

1 Claim, 3 Drawing Sheets

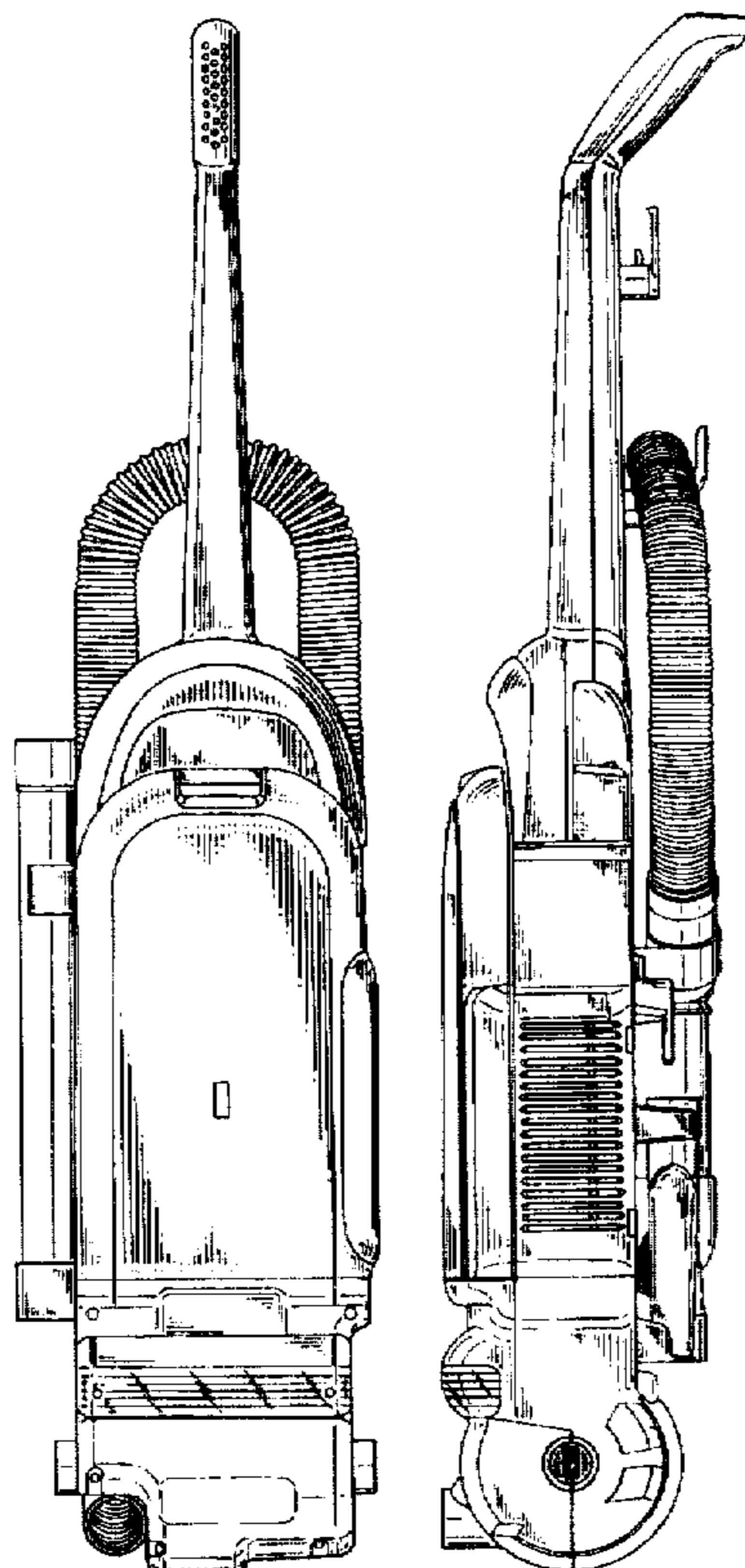

FIG.-1

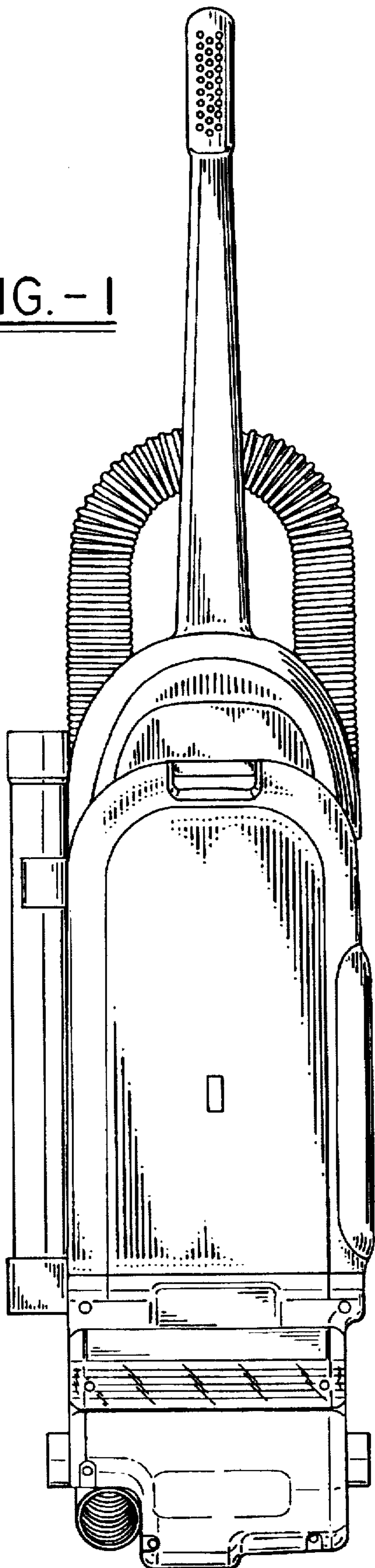
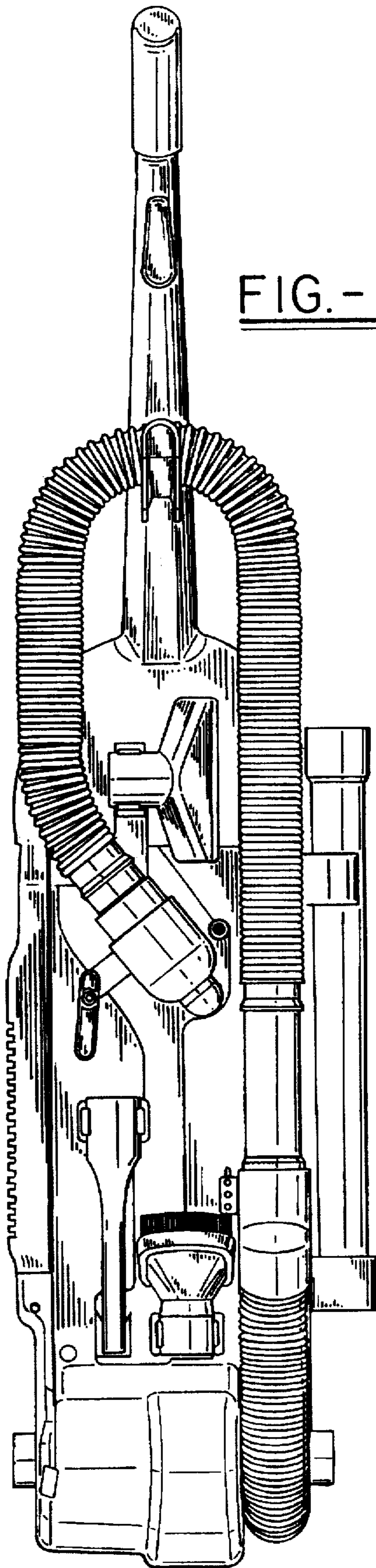
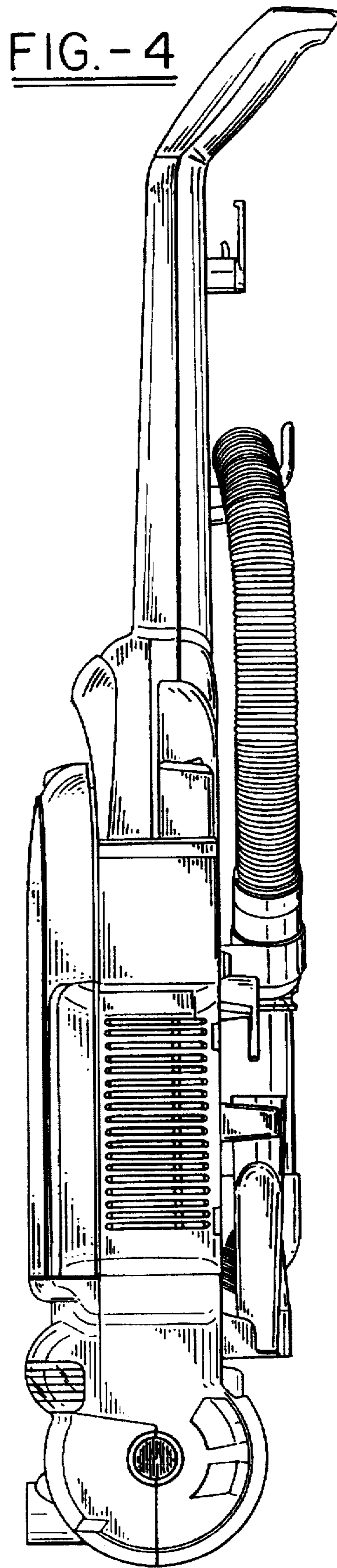
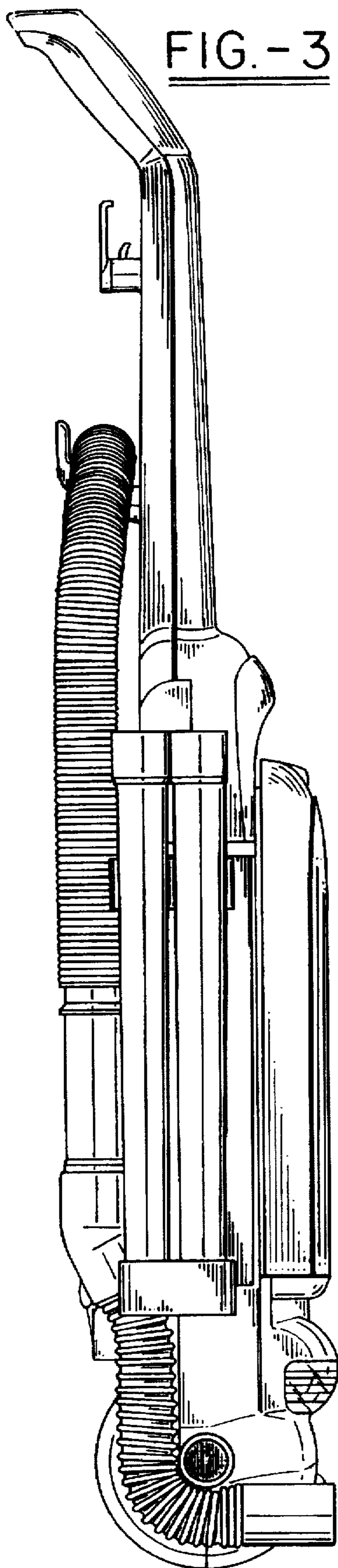

FIG.-2





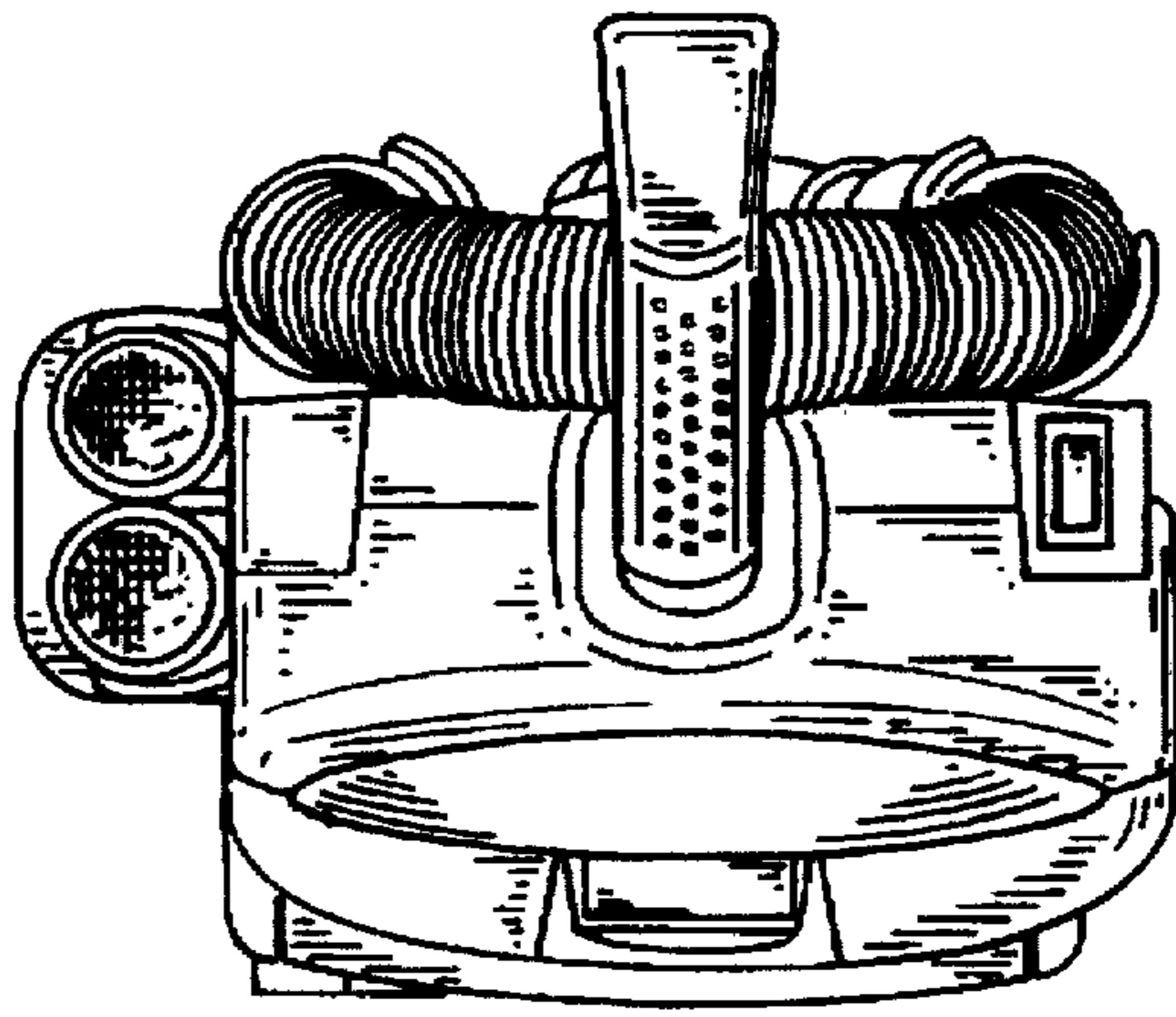

FIG. - 5

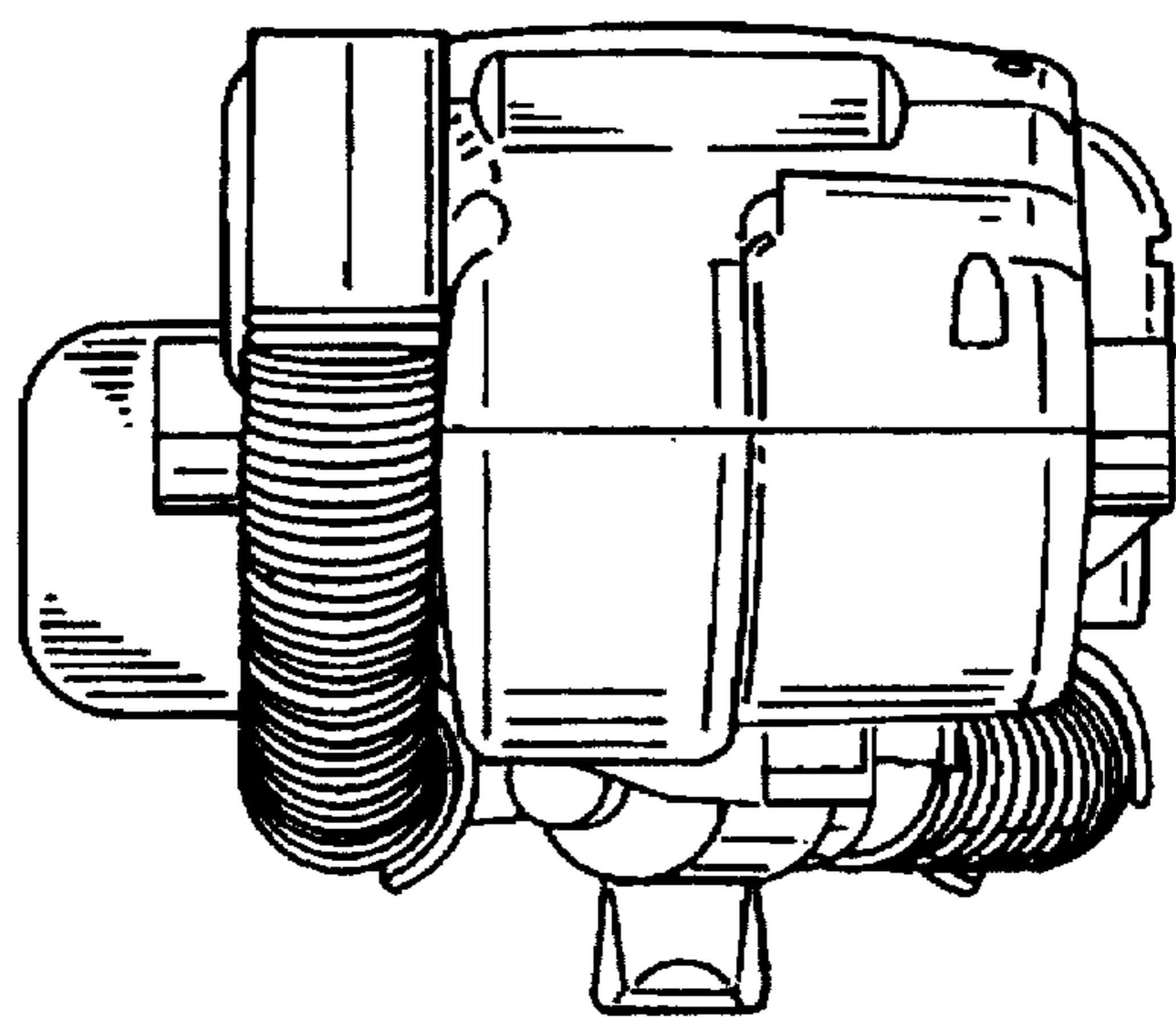

FIG. - 6