



US00D391665S

United States Patent [19]
Yang

[11] **Patent Number:** **Des. 391,665**
[45] **Date of Patent:** ****Mar. 3, 1998**

[54] **DESK LAMP**

[75] **Inventor:** **Roger Yang, Hsien, Taiwan**

[73] **Assignee:** **Be-Yang Industrial Corp., Hsien, Taiwan**

[**] **Term:** **14 Years**

[21] **Appl. No.:** **67,841**

[22] **Filed:** **Mar. 20, 1997**

[51] **LOC (6) Cl.** **26-05**

[52] **U.S. Cl.** **D26/108; D26/63**

[58] **Field of Search** **D26/60-66, 93, D26/102-112; 362/410-414, 269, 275, 287, 418, 419, 427**

[56] **References Cited**

U.S. PATENT DOCUMENTS

D. 80,814	3/1930	Thurber et al.	D26/107
D. 375,378	11/1996	Wang	D26/65
3,694,647	9/1972	Chapman et al.	362/411

OTHER PUBLICATIONS

B. A. Pargh Spring and Summer catalog, p. 111, tensor desk lamp, 1985.

Primary Examiner—Susan J. Lucas
Attorney, Agent, or Firm—Lowe, Price, LeBlanc & Becker

[57] **CLAIM**

The ornamental design for a desk lamp, as shown and described.

DESCRIPTION

FIG. 1 is a perspective view thereof;
FIG. 2 is a front view thereof;
FIG. 3 is a rear view thereof;
FIG. 4 is a left side view thereof;
FIG. 5 is a right side view thereof;
FIG. 6 is a top view thereof; and
FIG. 7 is a bottom view thereof.

1 Claim, 4 Drawing Sheets

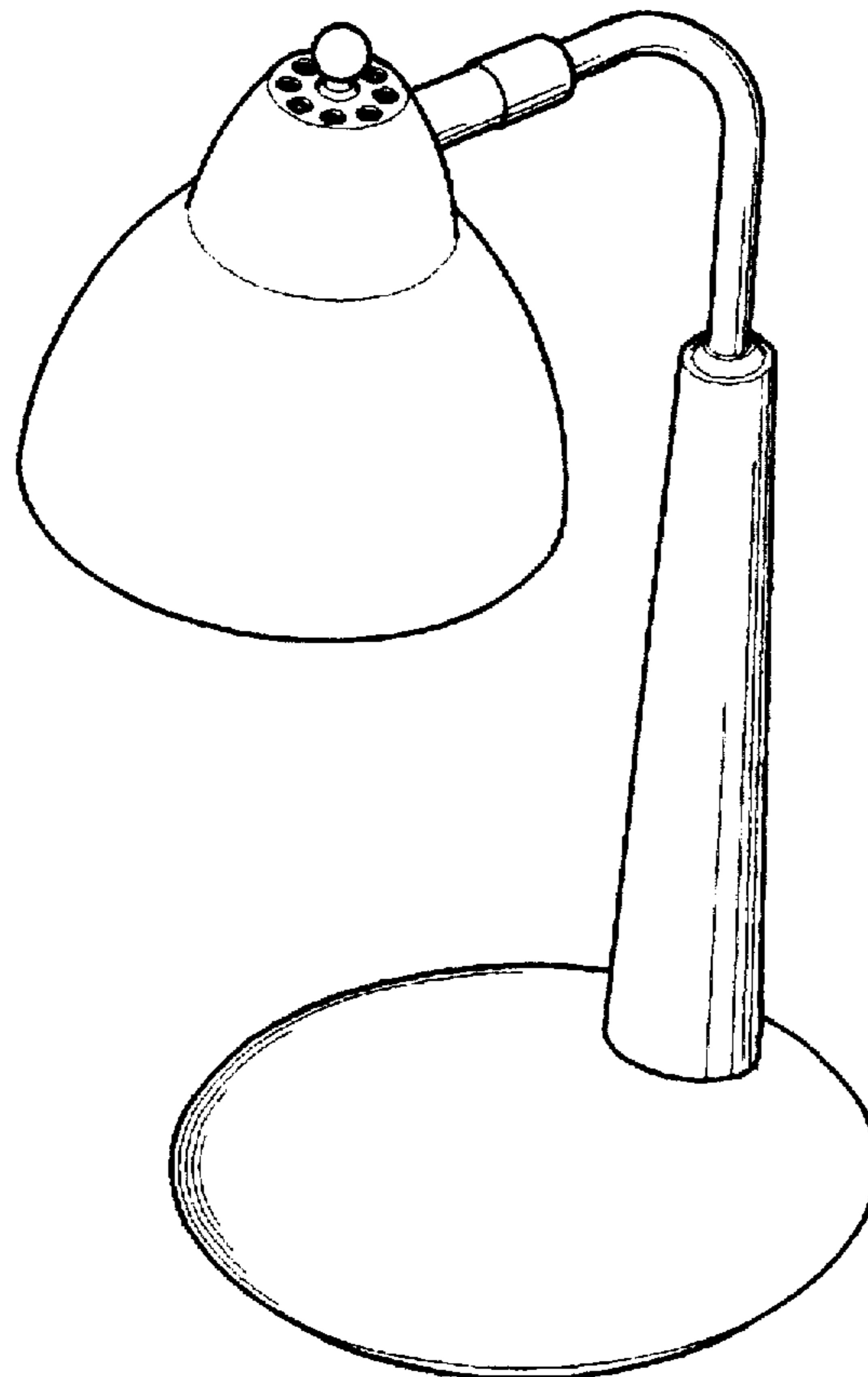

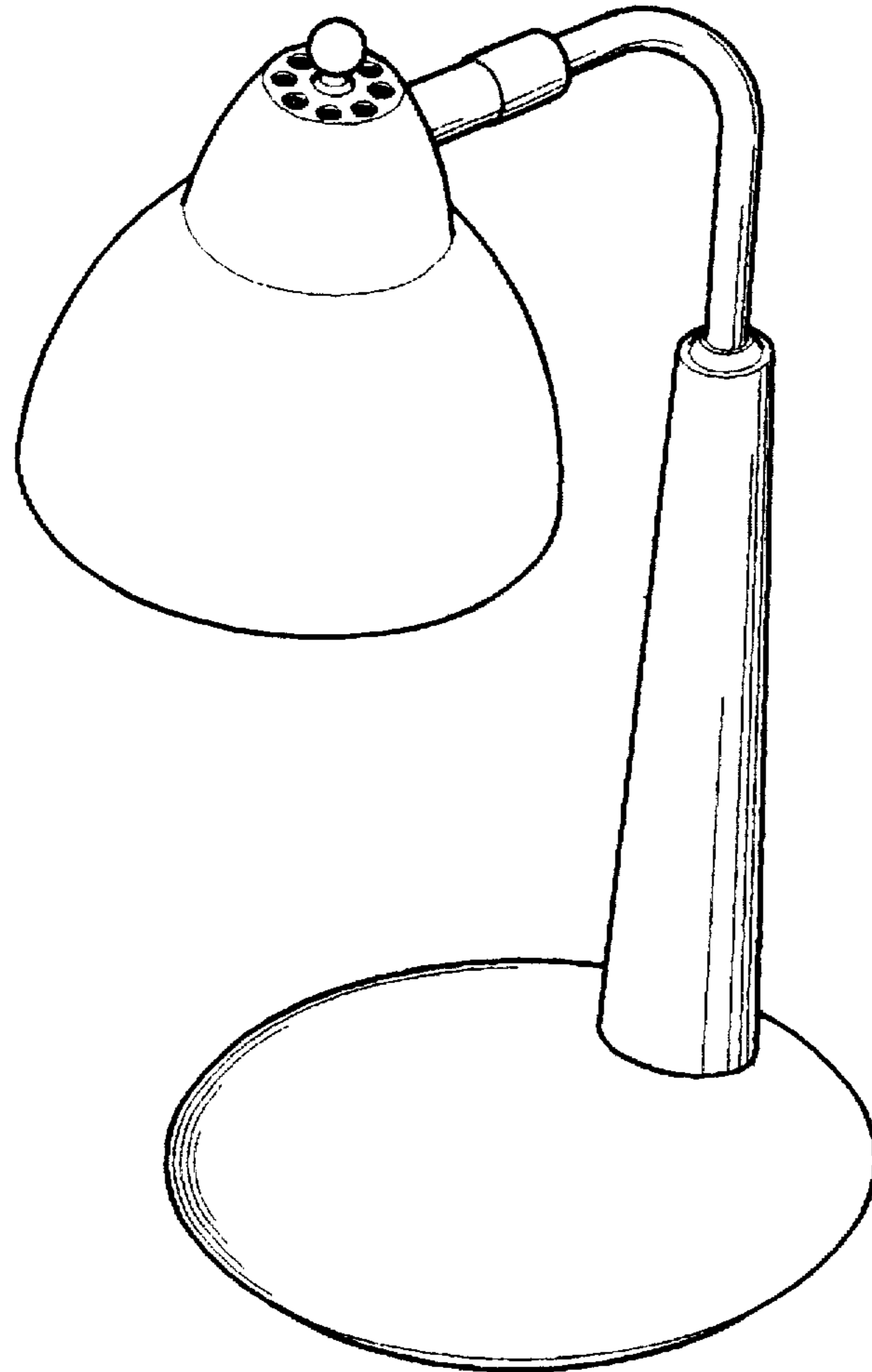

FIG. 1

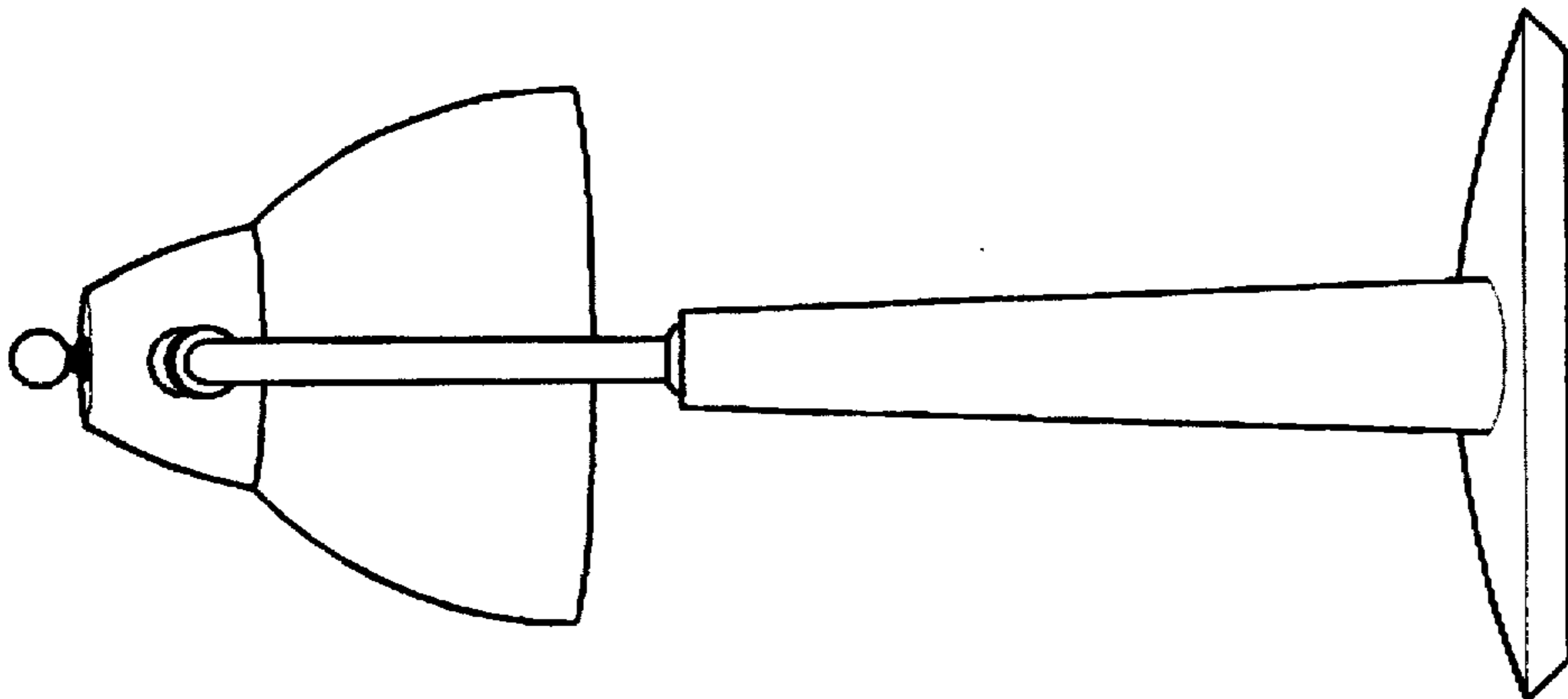

FIG. 3

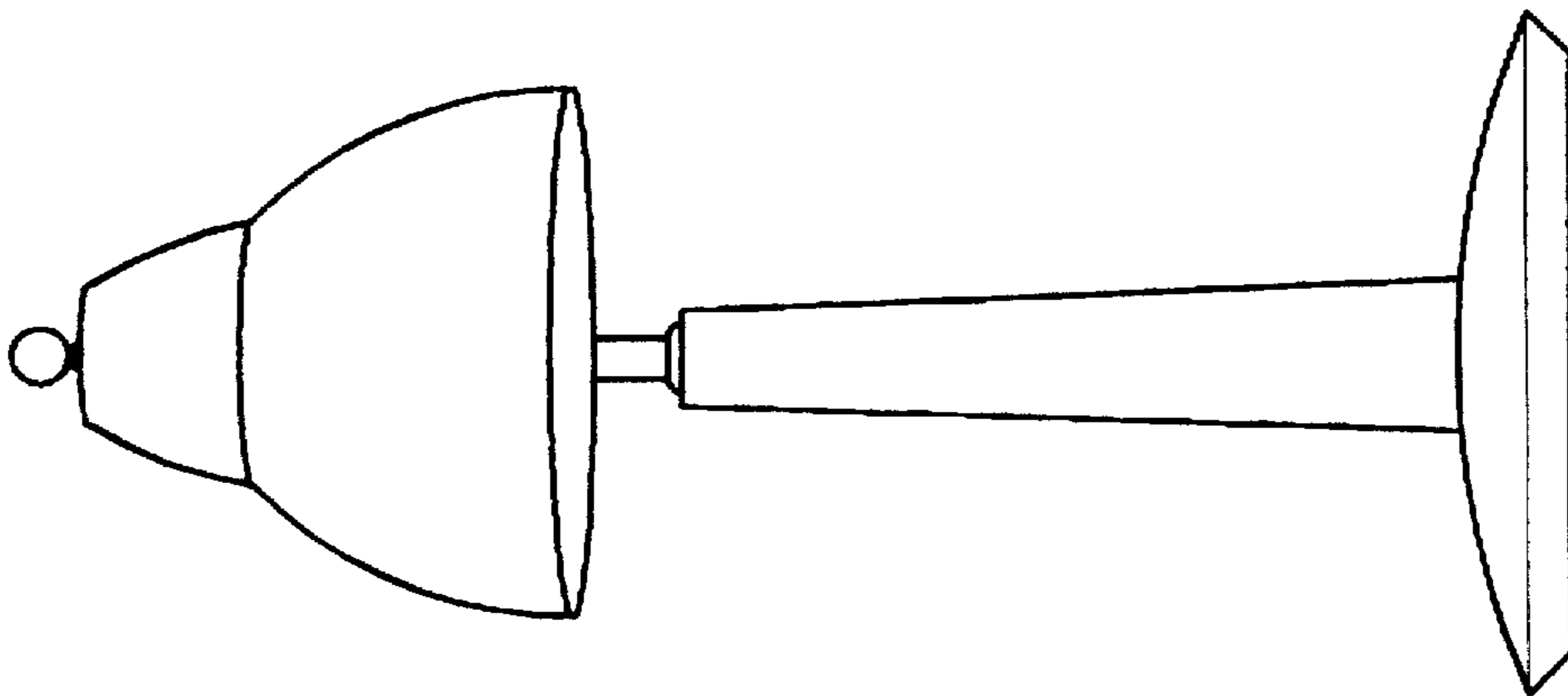

FIG. 2

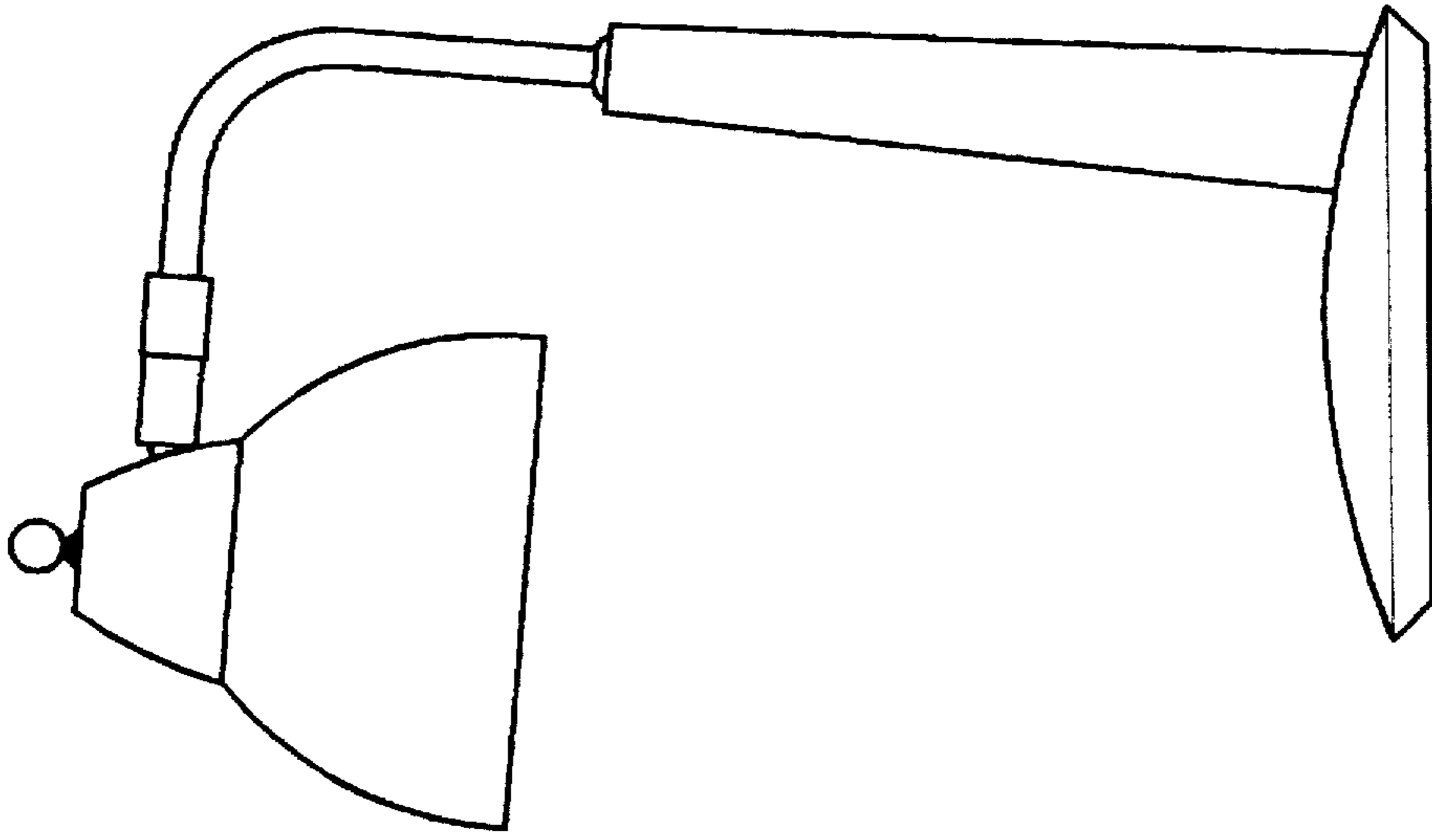

FIG. 5

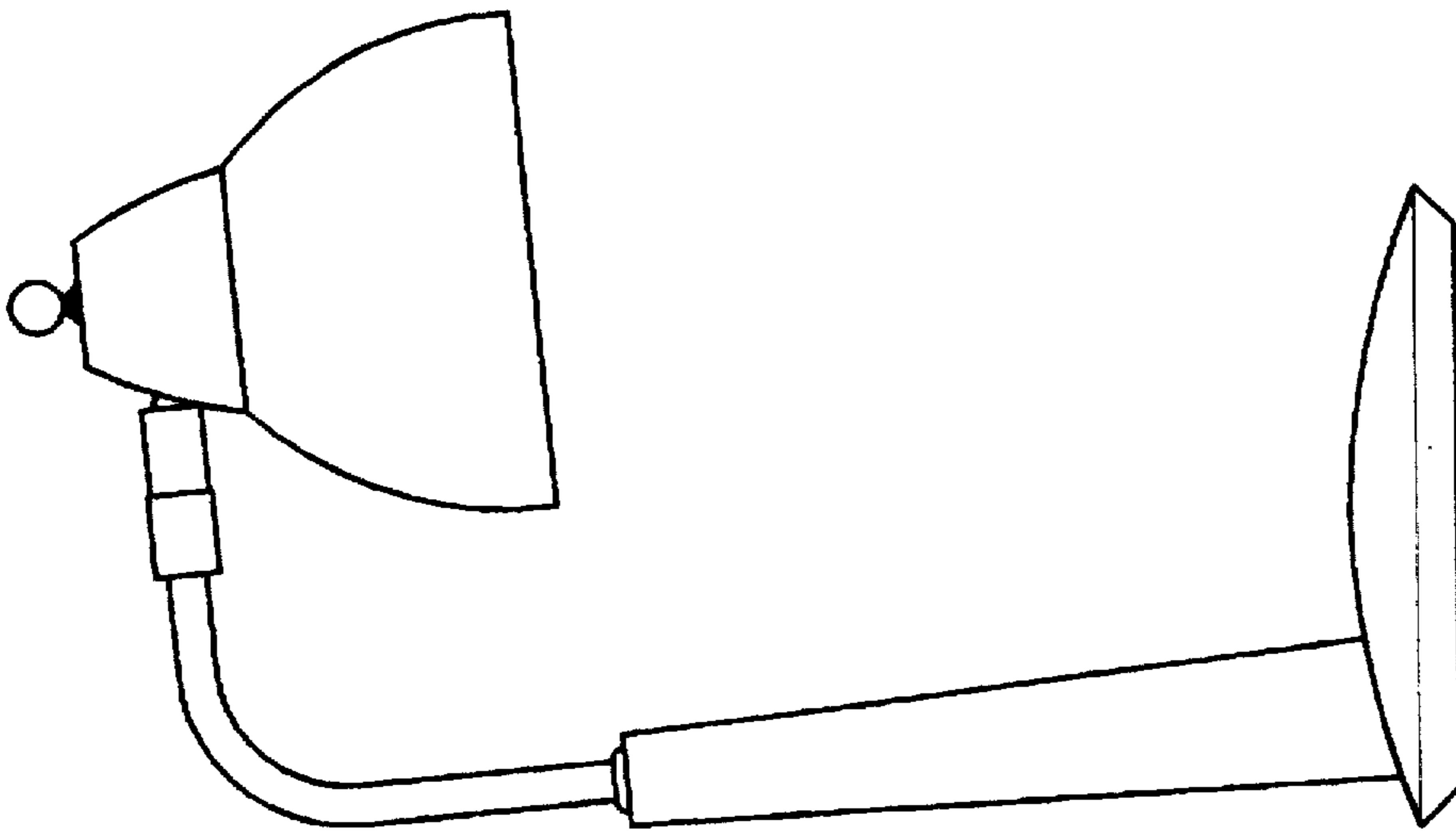

FIG. 4

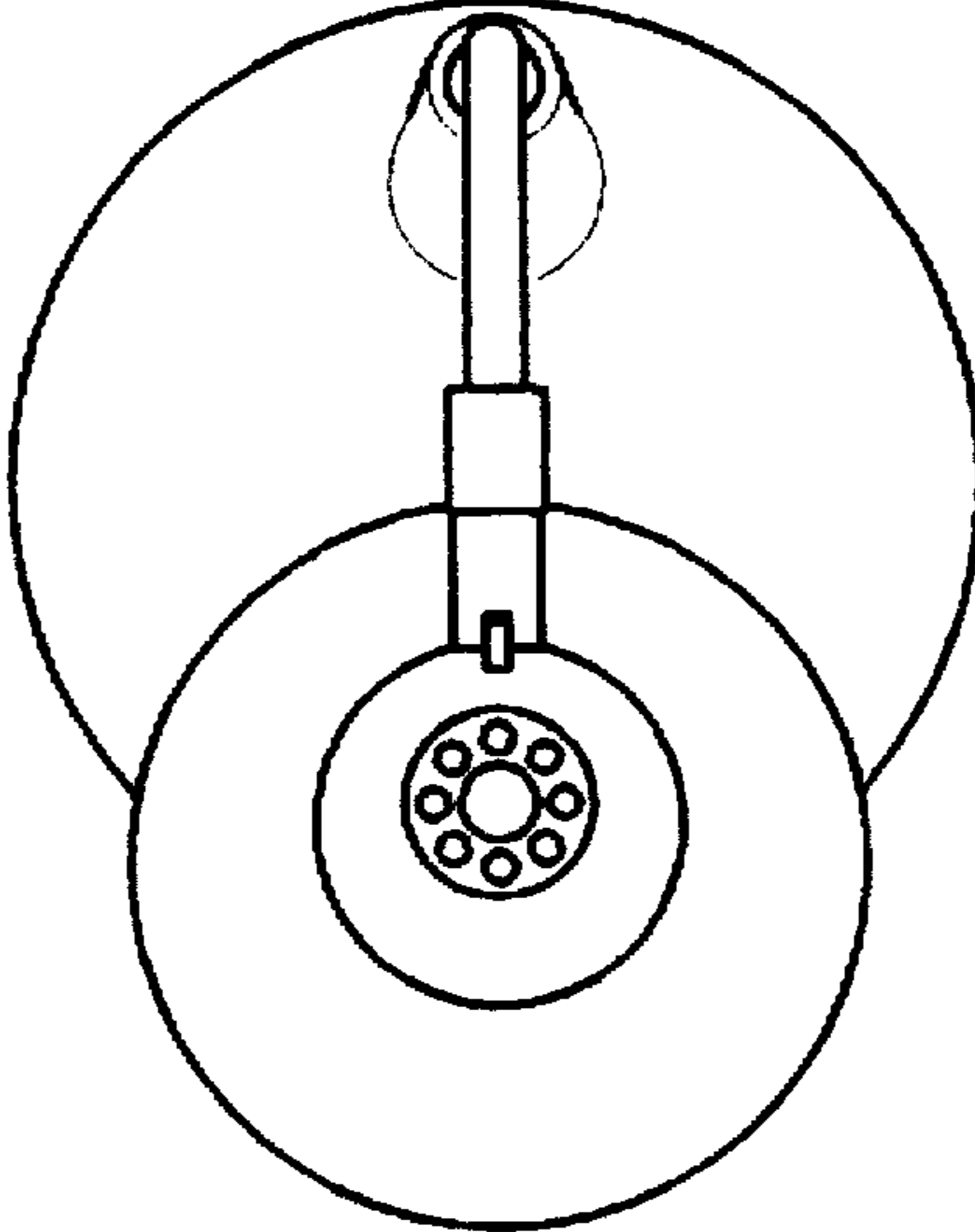

FIG. 6

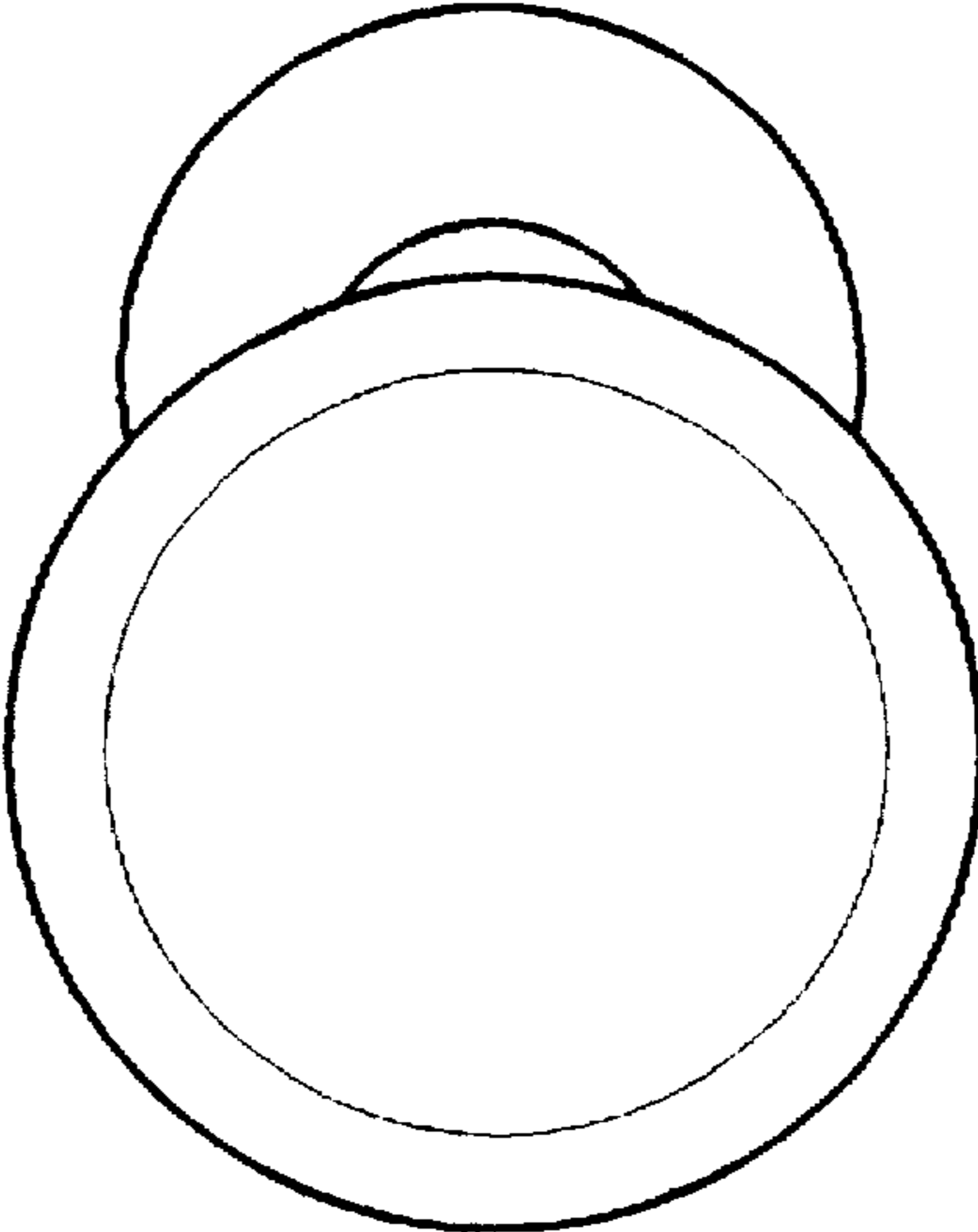

FIG. 7