



US00D391601S

United States Patent [19]

Kanaoka

[11] Patent Number: Des. 391,601

[45] Date of Patent: **Mar. 3, 1998

[54] CASH REGISTER

[75] Inventor: Yukio Kanaoka, Hiroshima-ken, Japan

[73] Assignee: Sharp Kabushiki Kaisha, Osaka, Japan

[**] Term: 14 Years

[21] Appl. No.: 61,173

[22] Filed: Oct. 17, 1996

[30] Foreign Application Priority Data

Apr. 17, 1996	[JP]	Japan	8-11222
Apr. 19, 1996	[JP]	Japan	8-11223

[51] LOC (6) Cl. 18-01

[52] U.S. Cl. D18/4; D14/105

[58] Field of Search D18/1, 2, 4, 6, D18/7, 11, 12; D14/100, 105, 106, 115; 235/1 D, 1 E, 2, 4, 7 R, 10, 145, 375, 380, 419; 364/404, 405

[56] References Cited

U.S. PATENT DOCUMENTS

D. 333,147	2/1993	Miyake et al.	D18/4
D. 353,613	12/1994	Miyake et al.	D18/4
D. 354,976	1/1995	Miyake et al.	D18/4
D. 354,977	1/1995	Miyake et al.	D18/4
D. 361,757	8/1995	Mizusugi et al.	D18/4 X
D. 362,427	9/1995	Mizusugi et al.	D18/4 X
D. 370,493	6/1996	Watanabe et al.	D18/4

D. 372,042	7/1996	Mizusugi et al.	D18/4
D. 372,043	7/1996	Mizusugi et al.	D18/4
D. 374,683	10/1996	Jung	D18/4

Primary Examiner—Caron D. Veynar
Attorney, Agent, or Firm—Nixon & Vanderhye

[57] CLAIM

The ornamental design for a "cash register", as shown and described.

DESCRIPTION

FIG. 1 is a top, front and right side perspective view of a cash register according to my design;
 FIG. 2 is a front elevational view thereof;
 FIG. 3 is a rear elevational view thereof;
 FIG. 4 is a top plan view thereof;
 FIG. 5 is a bottom plan view thereof;
 FIG. 6 is a left side elevational view thereof;
 FIG. 7 is a right side elevational view thereof;
 FIG. 8 is a top, front and right side perspective view of a second embodiment of a cash register according to my design;
 FIG. 9 is a front elevational view thereof;
 FIG. 10 is a rear elevational view thereof;
 FIG. 11 is a top plan view thereof;
 FIG. 12 is a bottom plan view thereof;
 FIG. 13 is a left side elevational view thereof; and,
 FIG. 14 is a right side elevational view thereof.

1 Claim, 10 Drawing Sheets

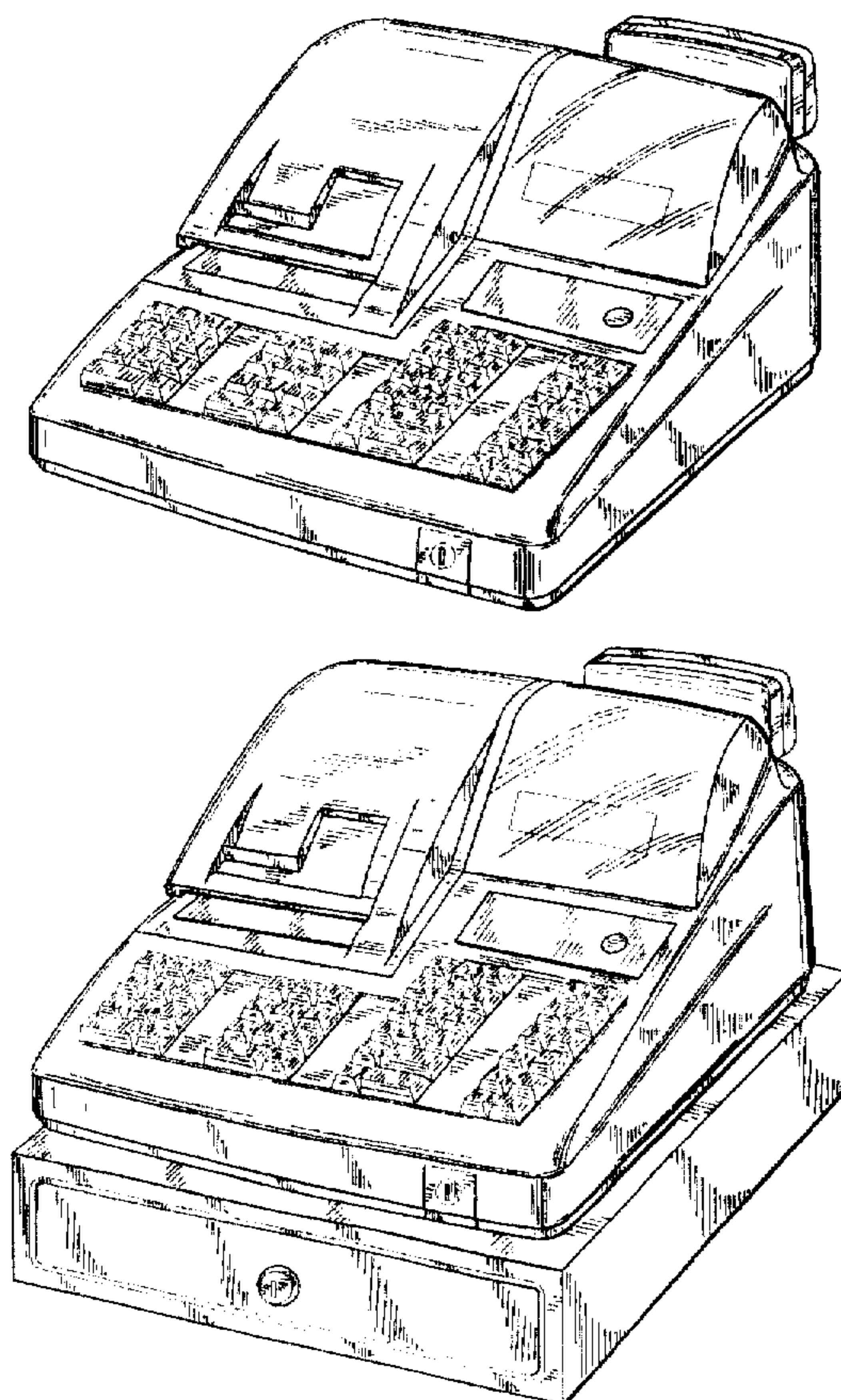

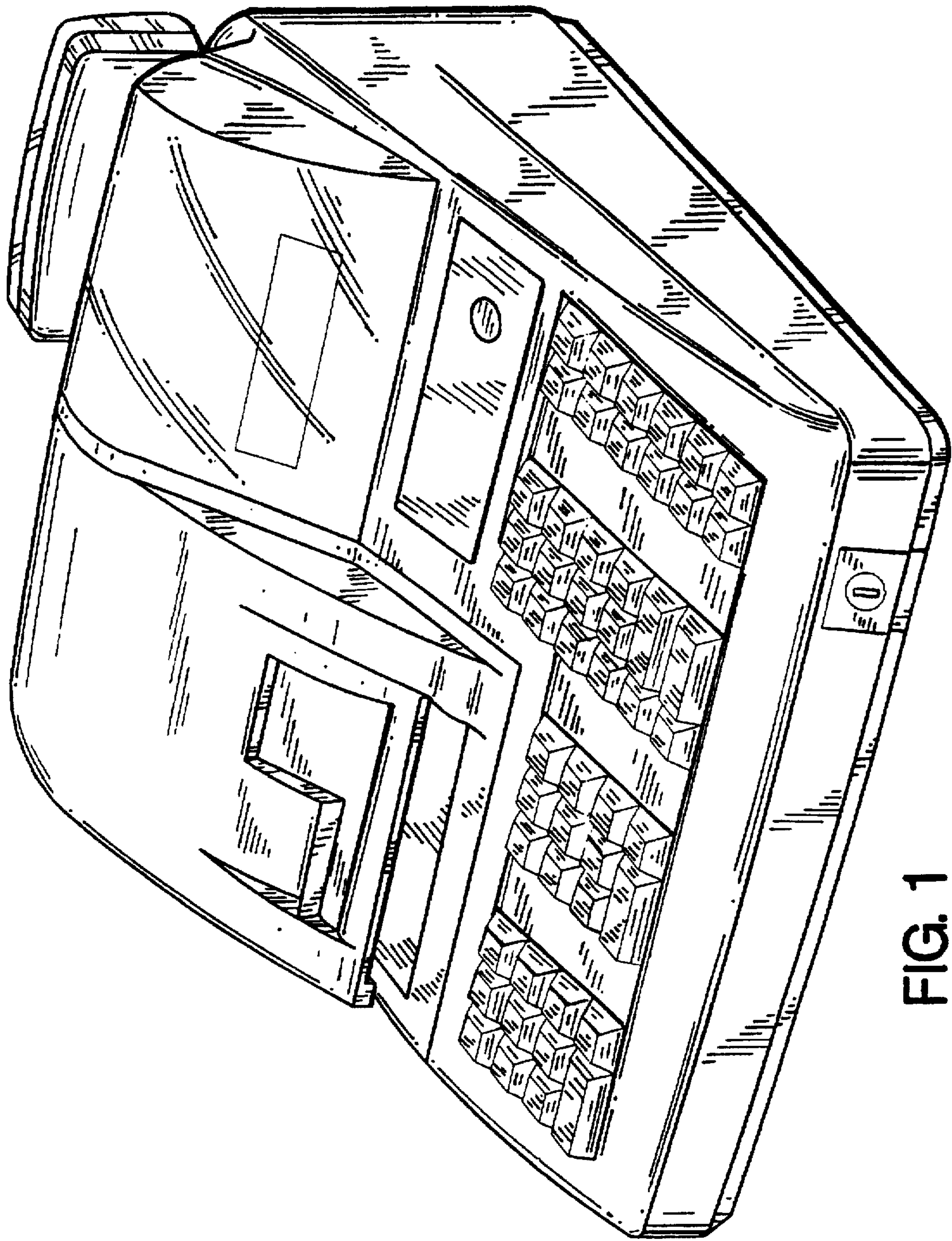

FIG. 1

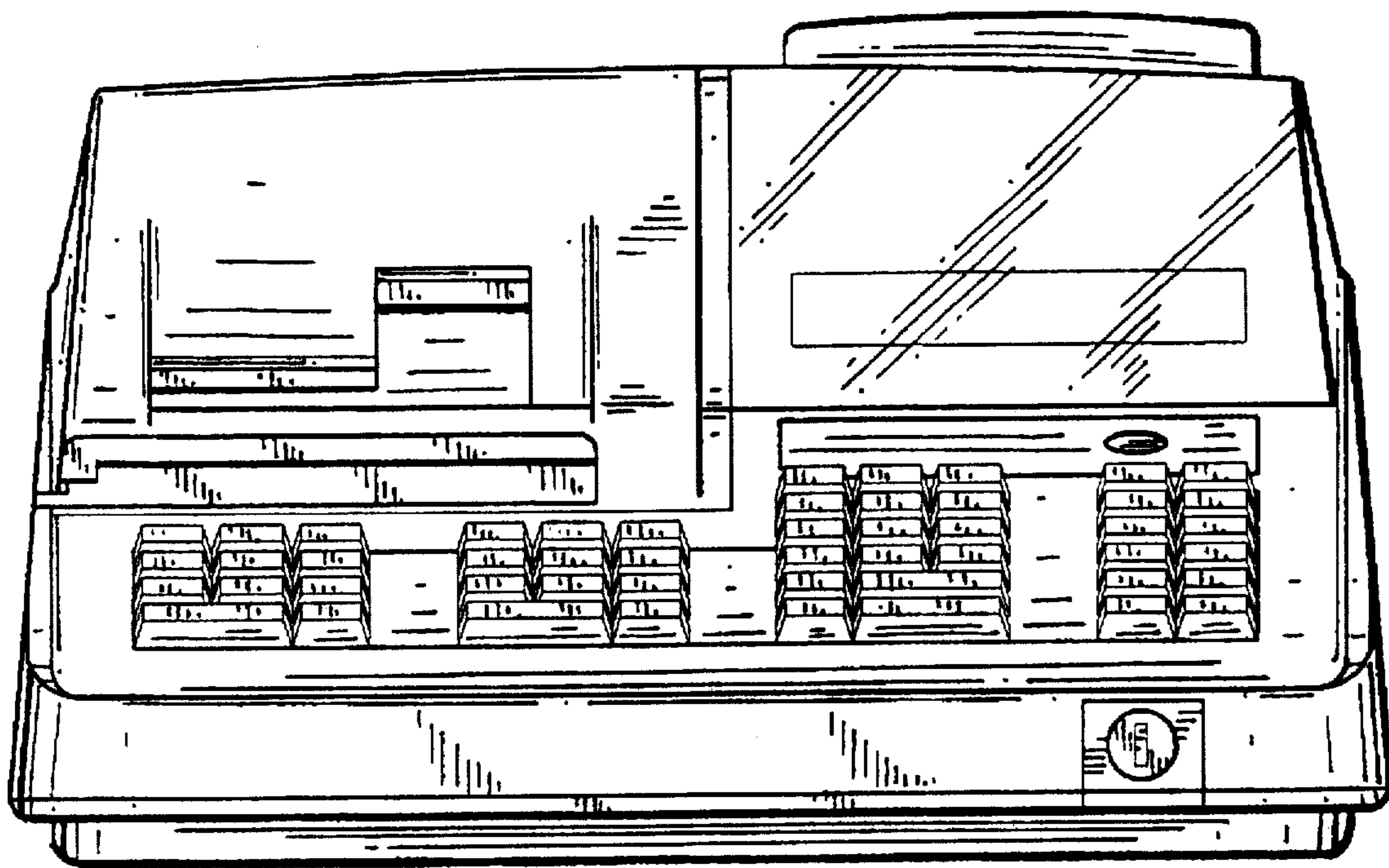

FIG. 2

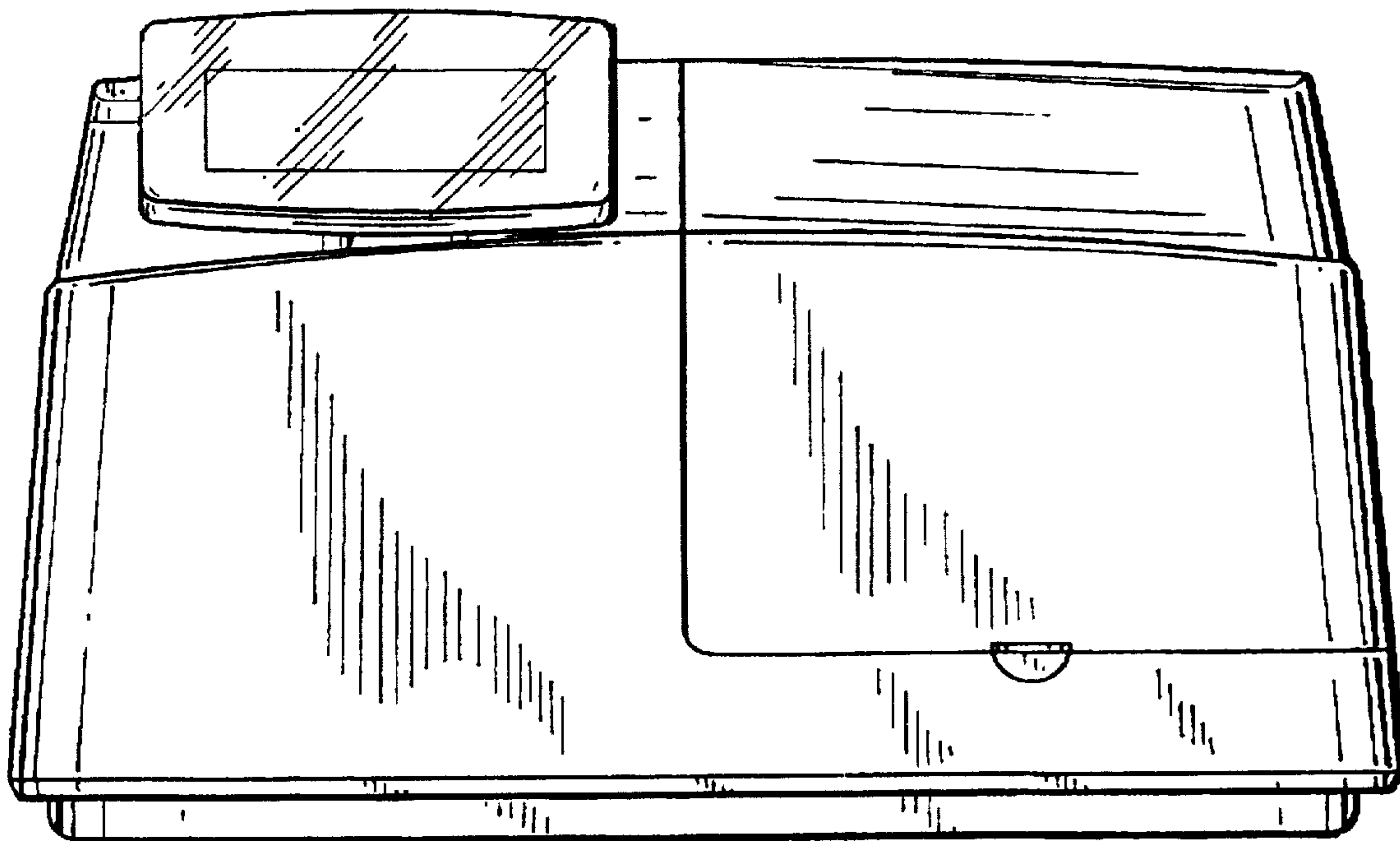

FIG. 3

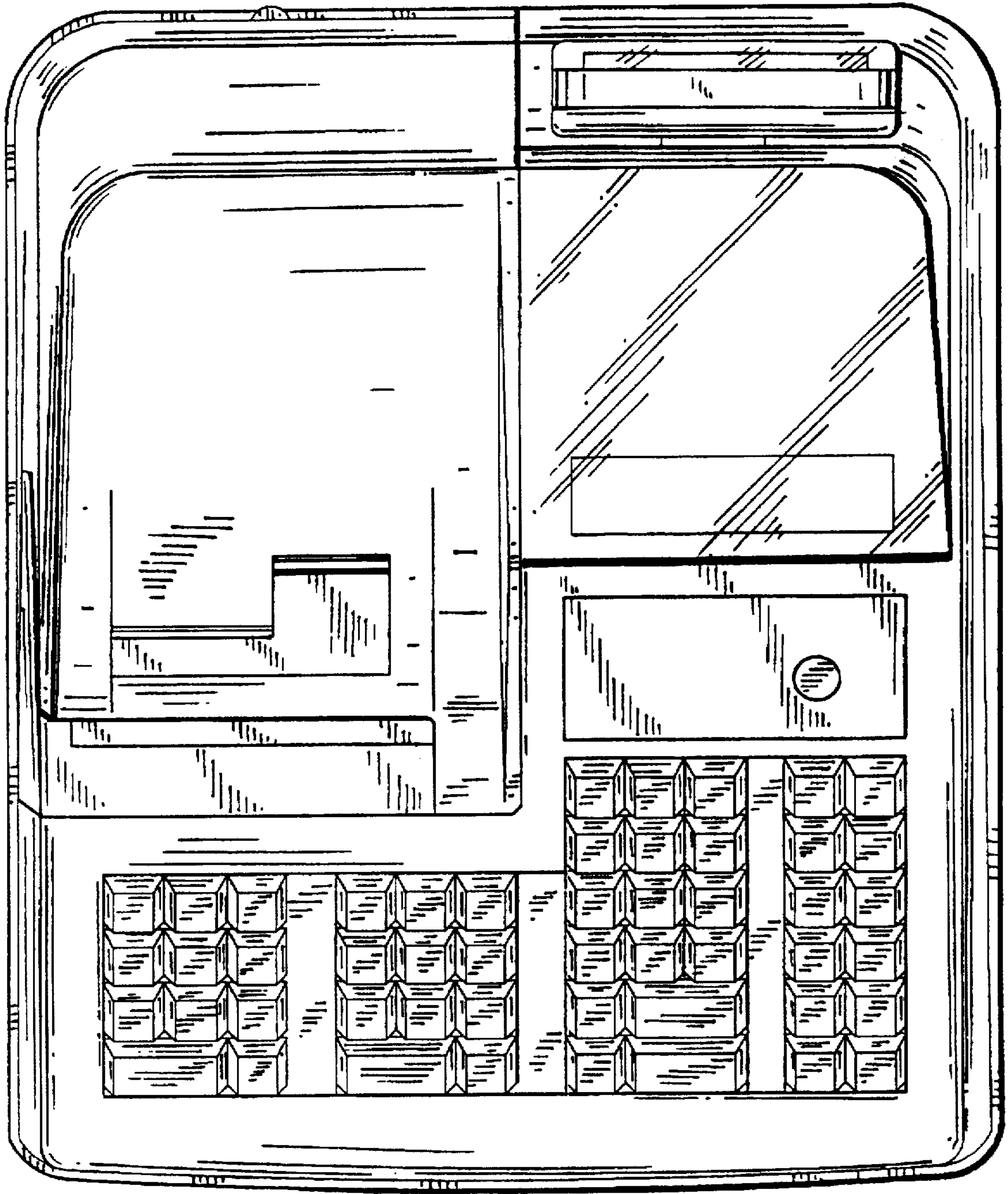

FIG. 4

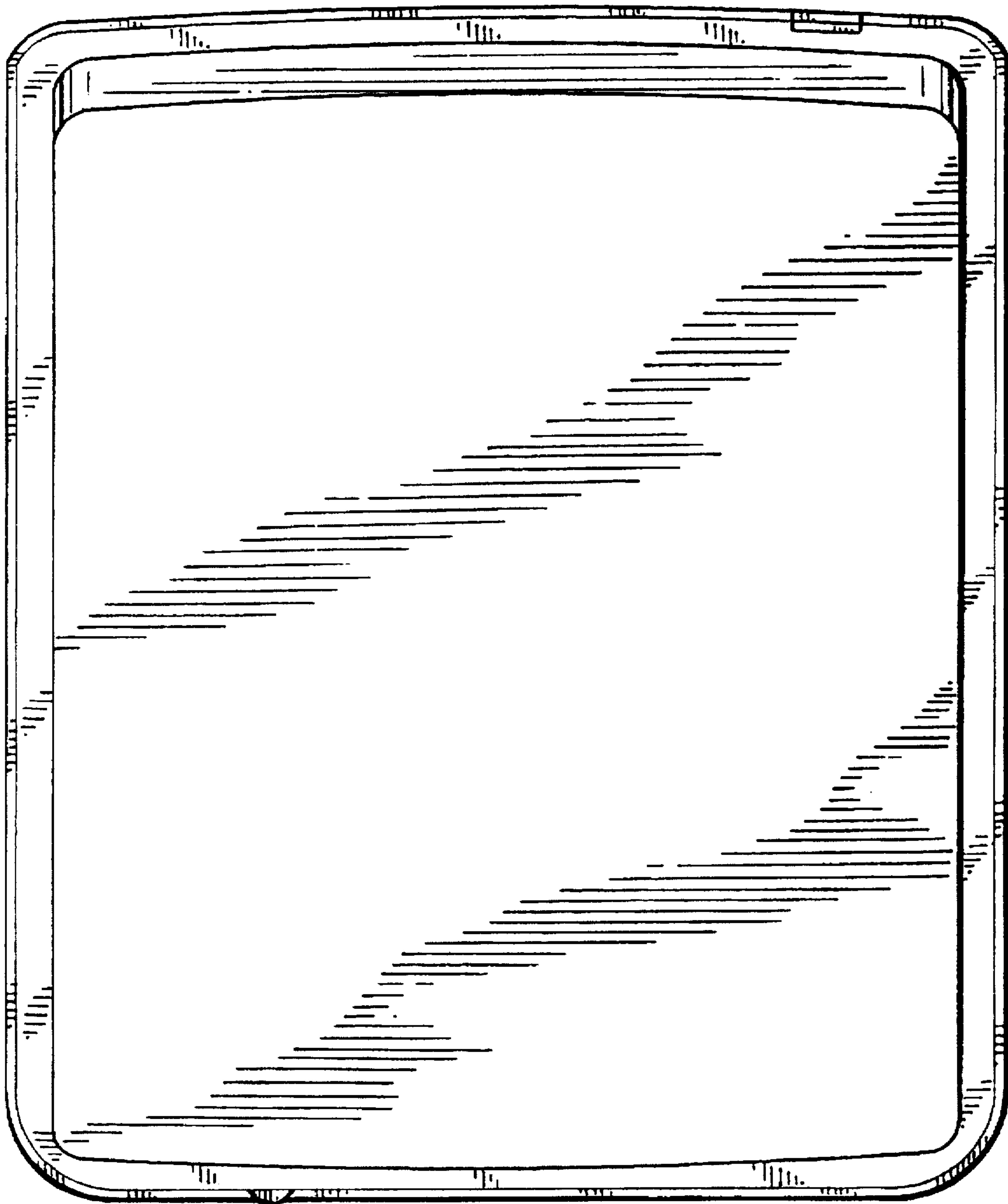

FIG. 5

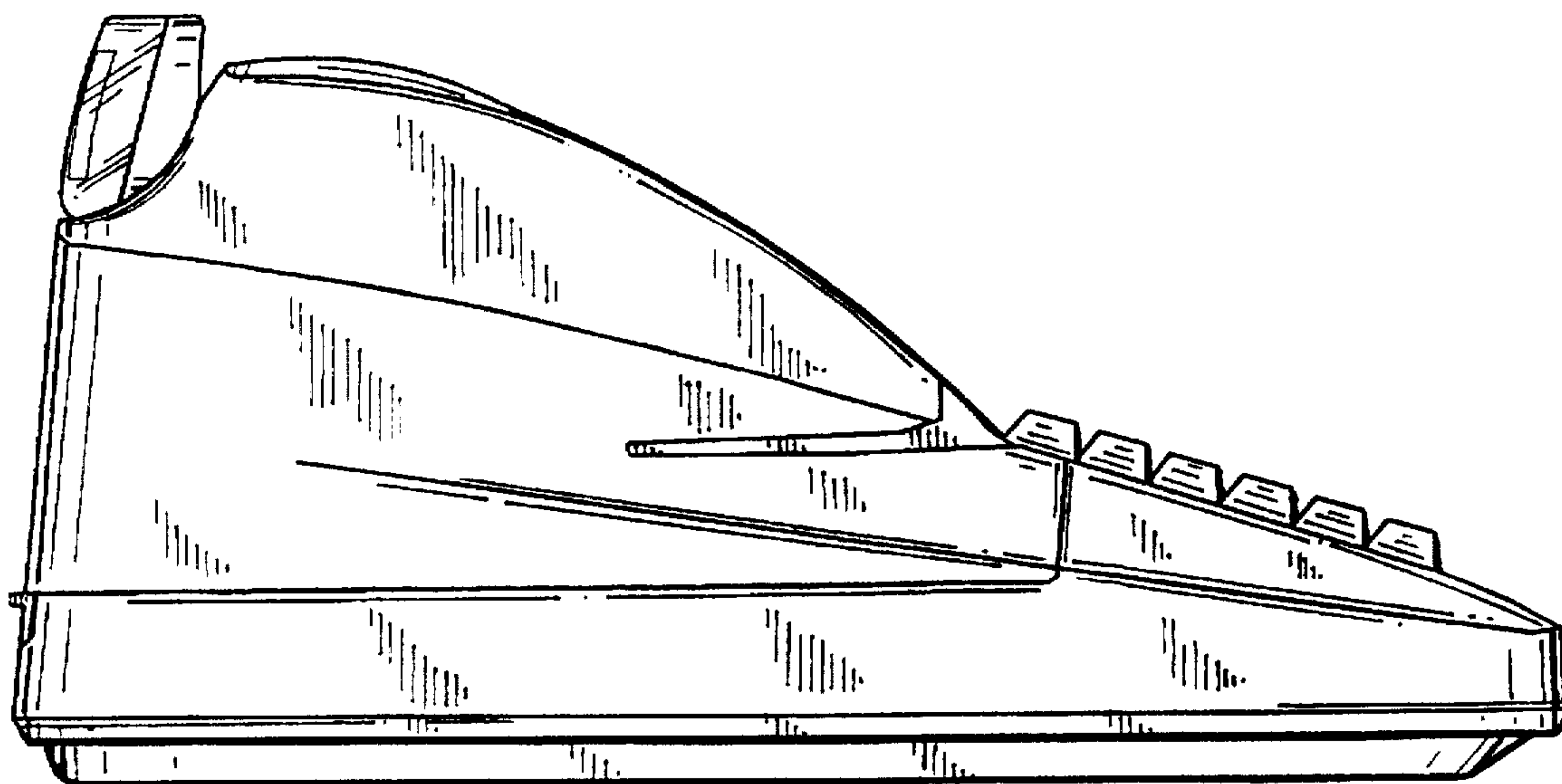

FIG. 6

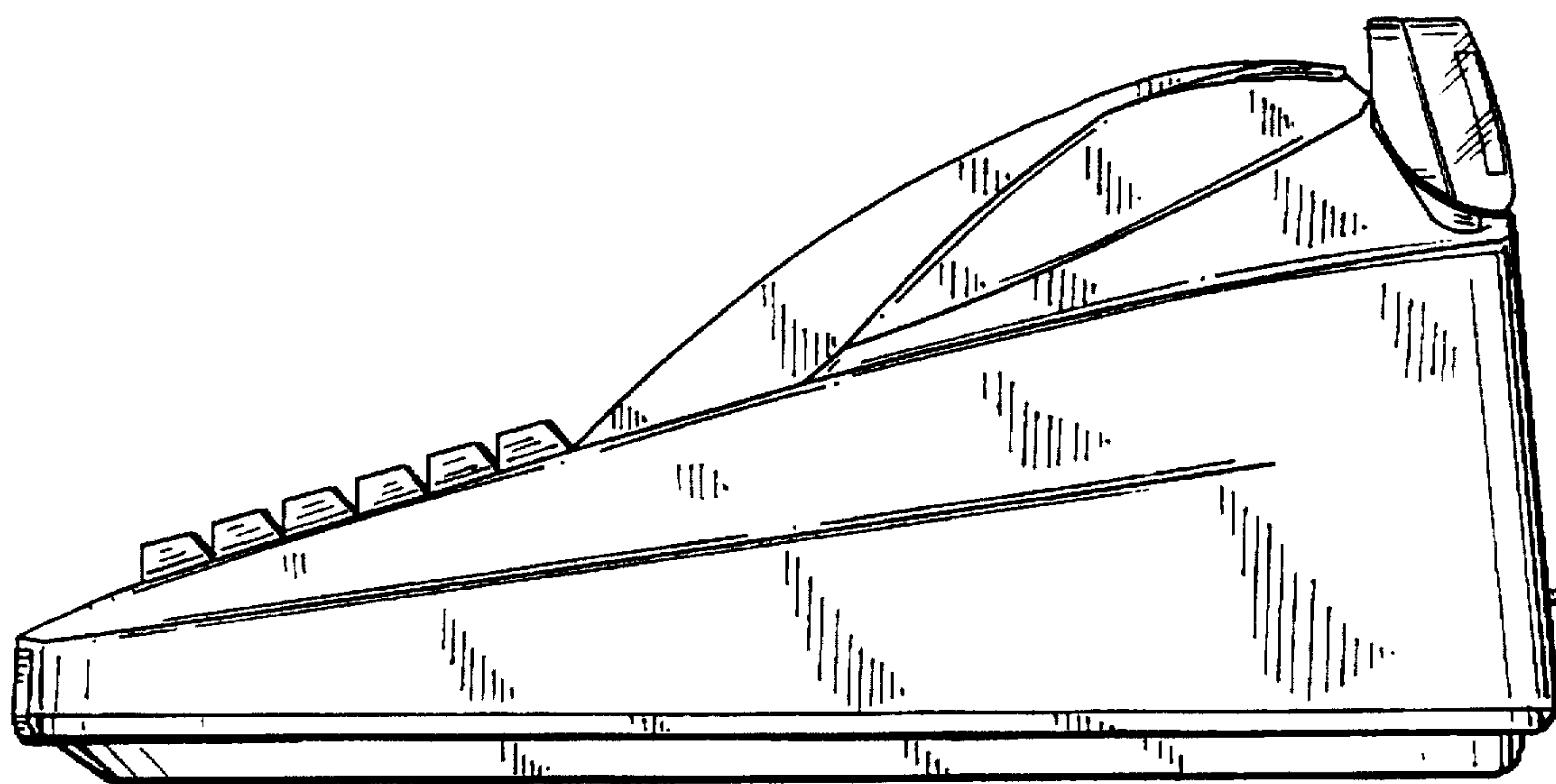

FIG. 7

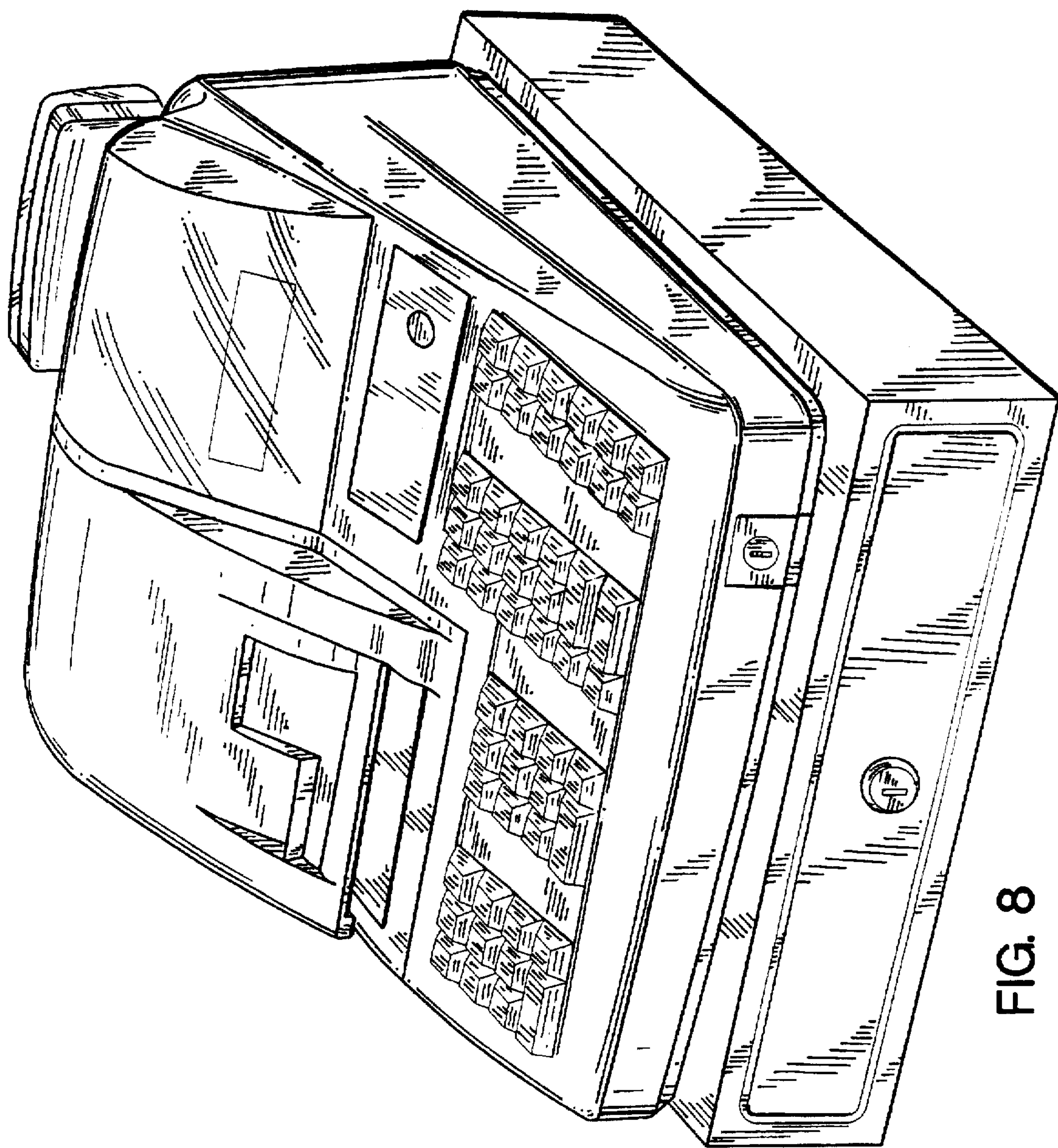

FIG. 8

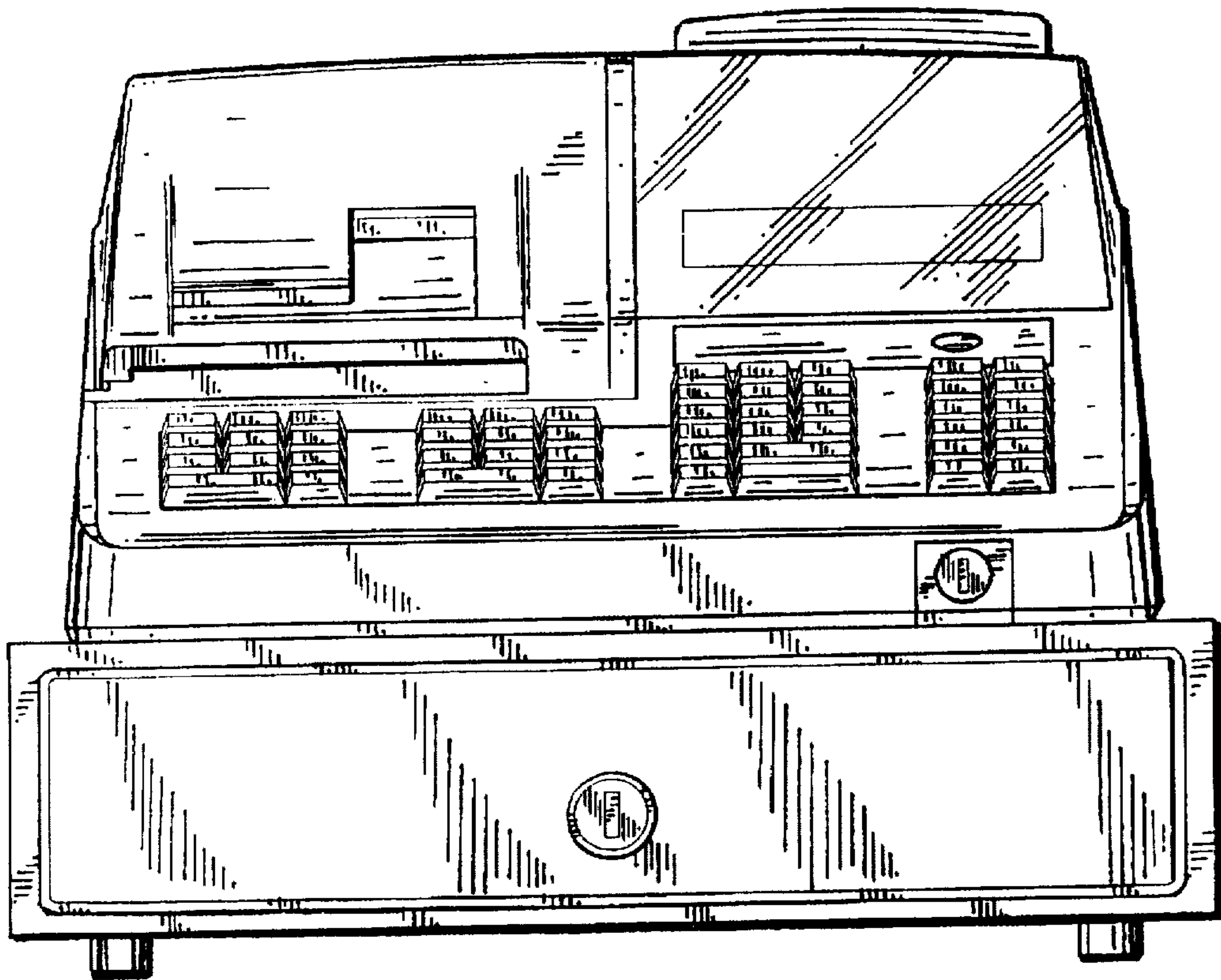

FIG. 9

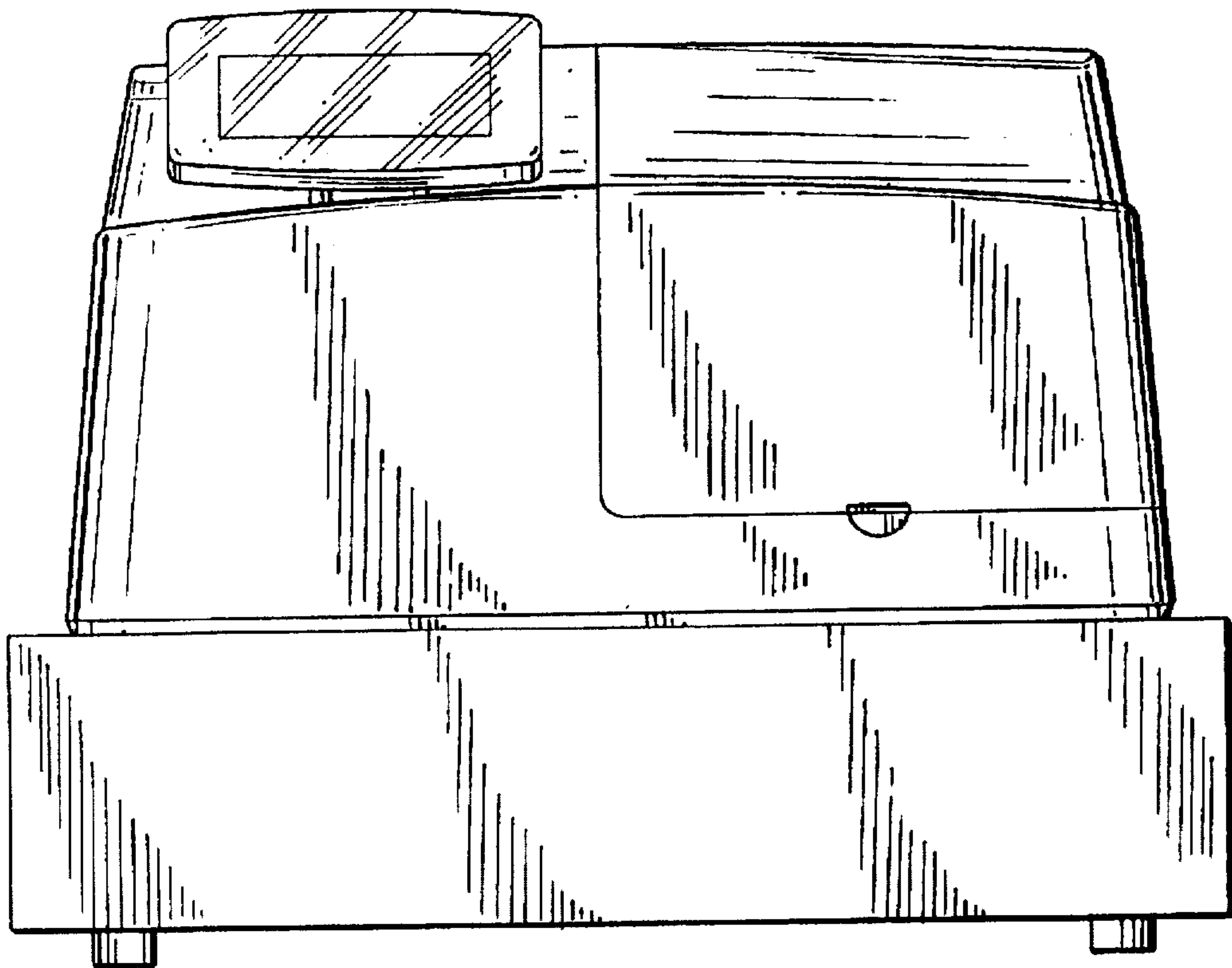

FIG. 10

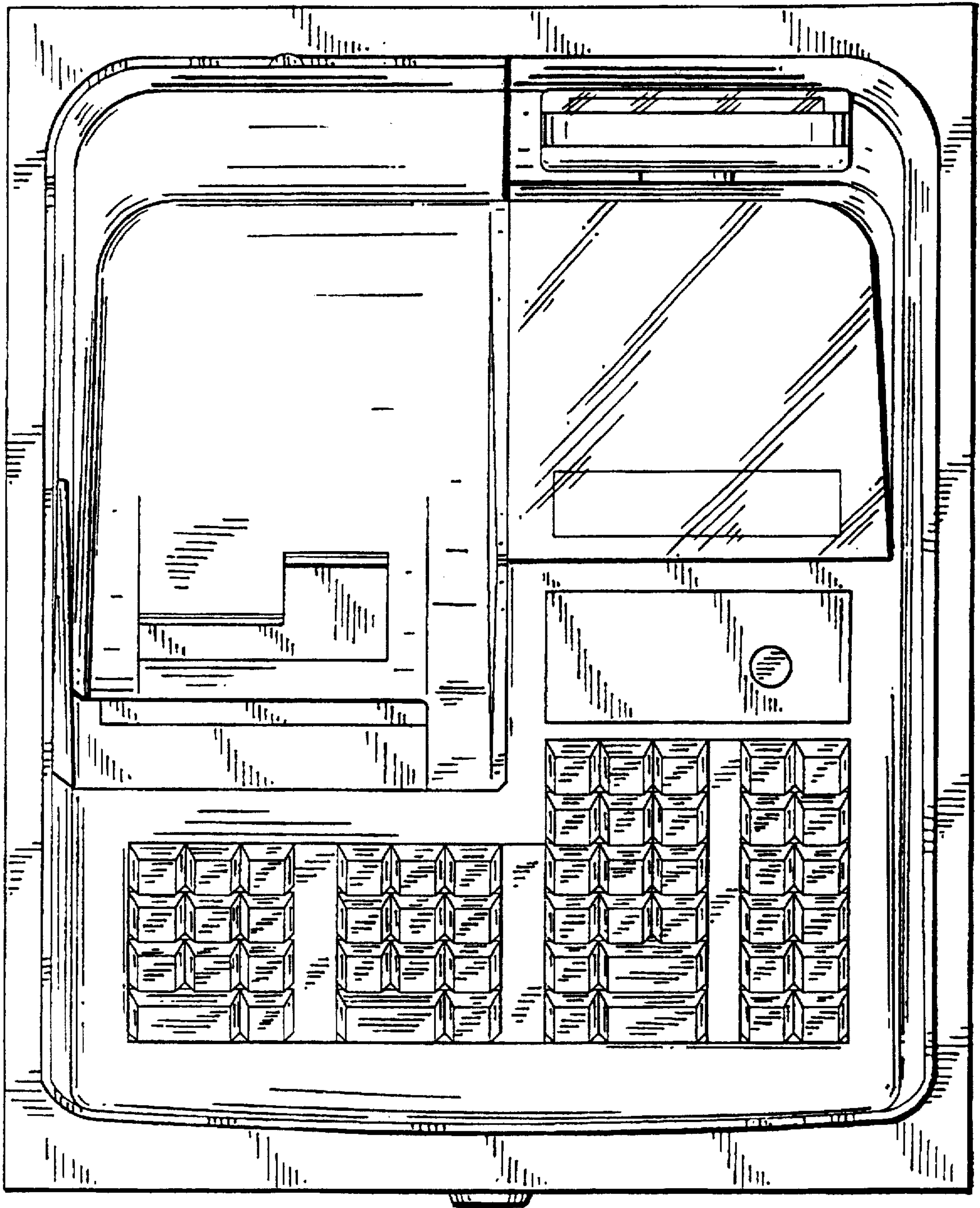

FIG. 11

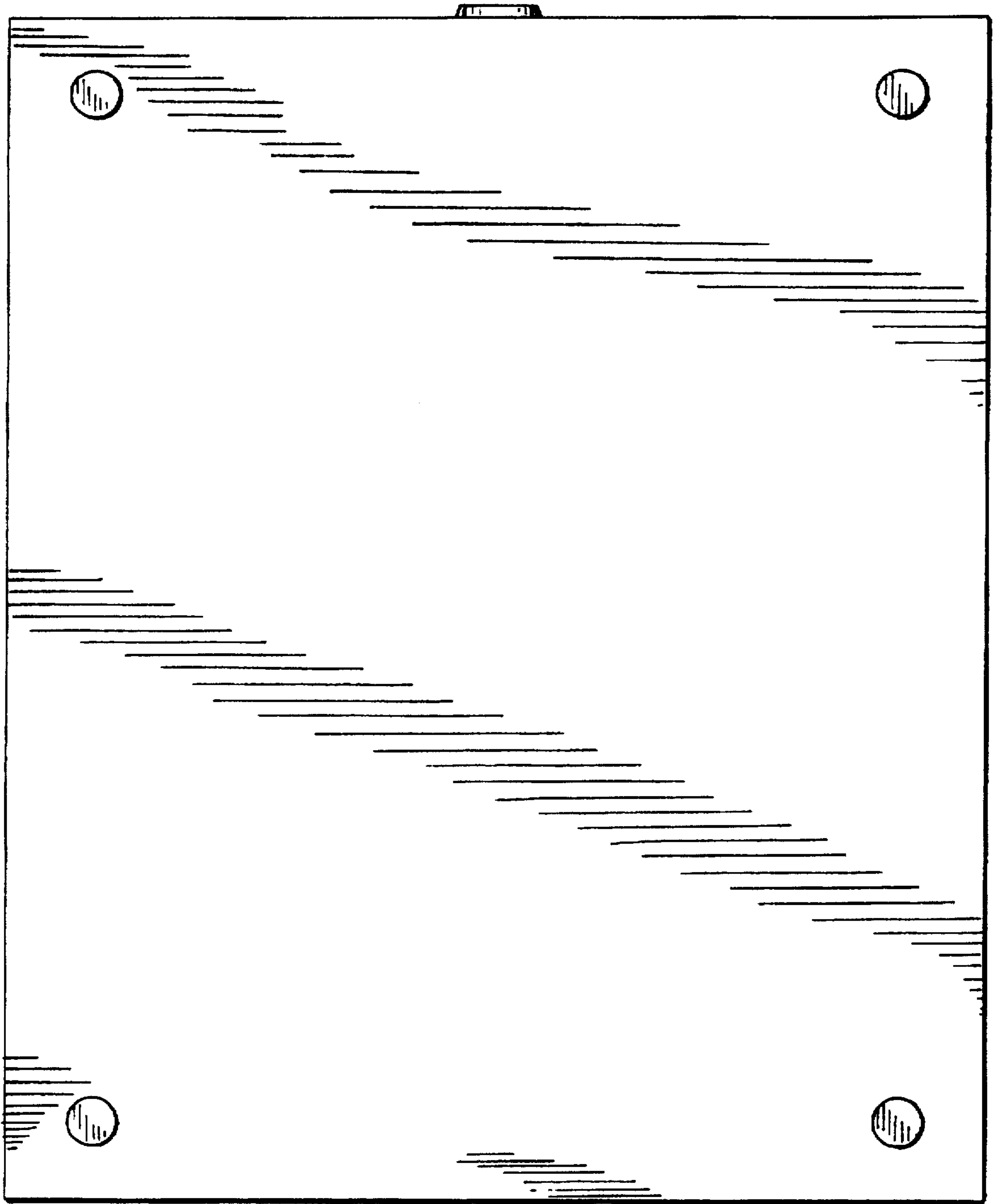

FIG. 12

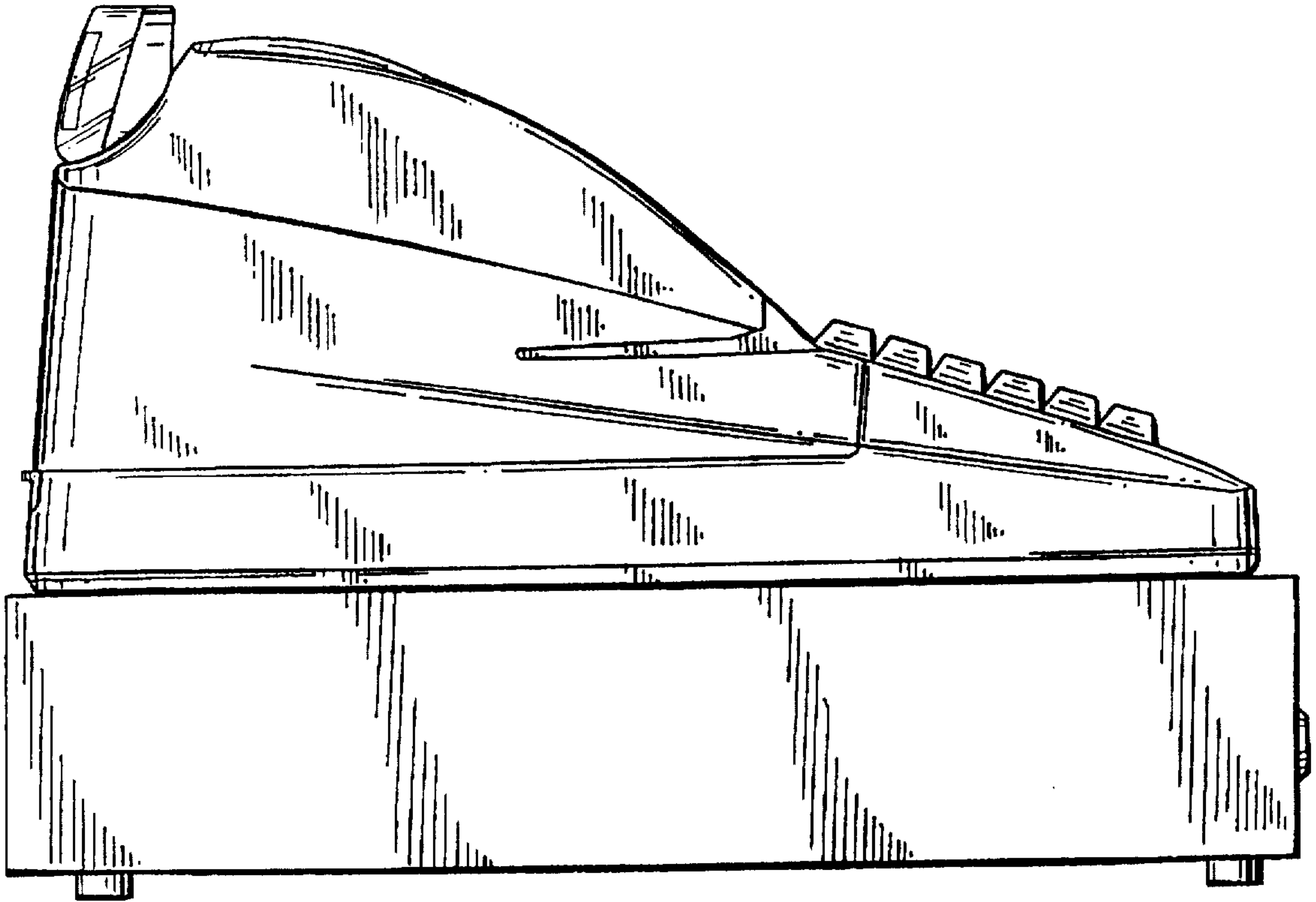

FIG. 13

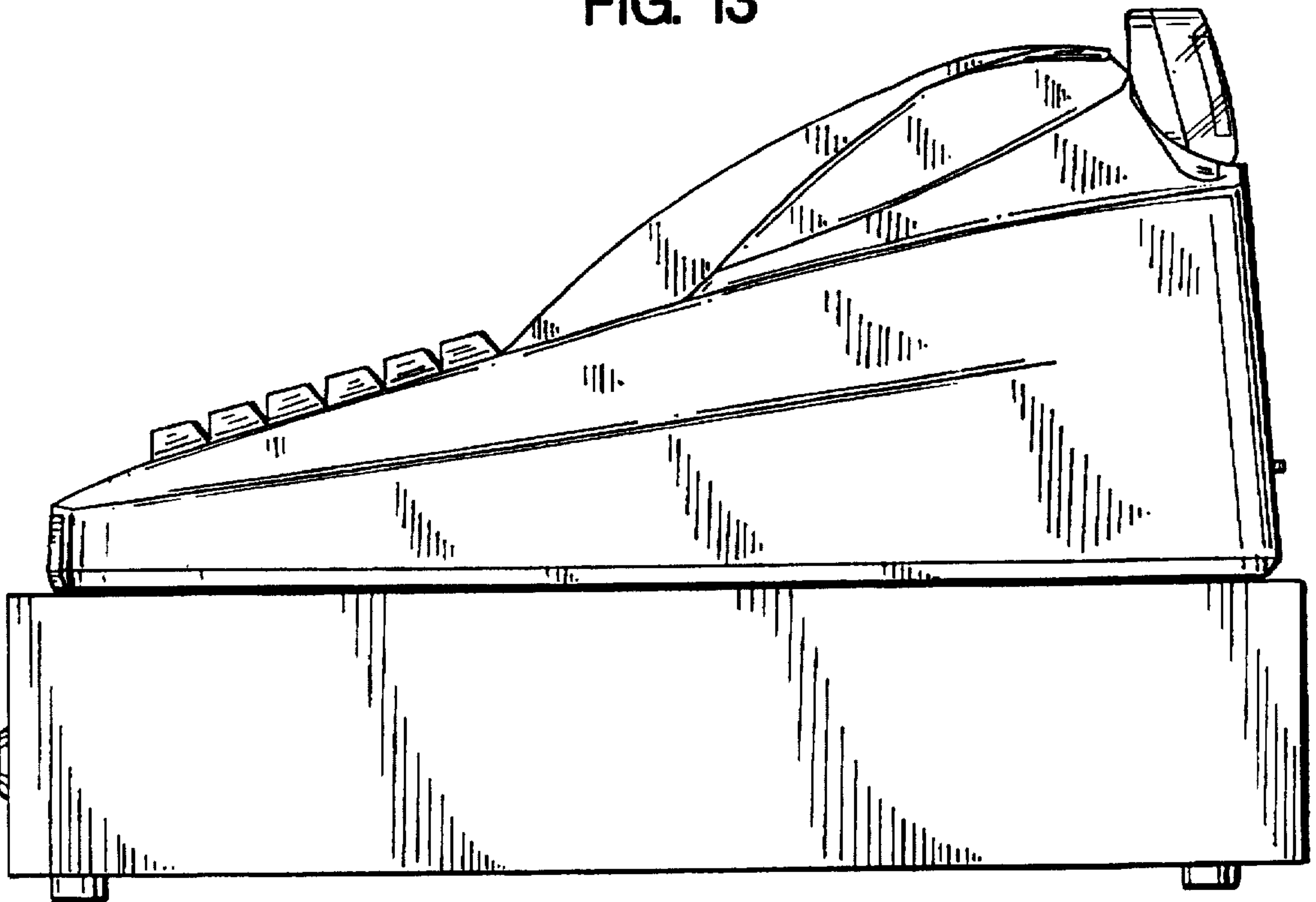

FIG. 14