

US00D391392S

United States Patent [19]

Adams

[11] Patent Number: **Des. 391,392**

[45] Date of Patent: ****Mar. 3, 1998**

[54] PET UMBRELLA

[76] Inventor: **Kathleen S. Adams**, 3948 Senasac Ave., Long Beach, Calif. 90808

[**] Term: **14 Years**

[21] Appl. No.: **57,282**

[22] Filed: **Jul. 22, 1996**

[51] LOC (6) Cl. **03-03**

[52] U.S. Cl. **D3/5; D30/144**

[58] Field of Search **D3/5, 6; D30/144; 135/90; 54/80.1; 119/850, 856, 858; 224/186, 187, 188, 189, 190**

[56] References Cited

U.S. PATENT DOCUMENTS

D. 324,117	2/1992	Antoine	D30/144
2,320,848	6/1943	Byars	224/187
3,918,238	11/1975	Iozzio	119/850
5,546,970	8/1996	Amato	135/90

OTHER PUBLICATIONS

Doctors Foster Smith Catalog, Poncho Slicker Doggiduds, p. 139, Apr. 17, 1995, Aug. 11, 1997.

Primary Examiner—Doris V. Coles
Assistant Examiner—Catherine R. Oliver
Attorney, Agent, or Firm—Harpman & Harpman

[57] CLAIM

The ornamental design for pet umbrella, as shown and described.

DESCRIPTION

FIG. 1 is a front, top and side perspective view of pet umbrella showing my new design; FIG. 2 is a front elevational view thereof, the back view being a mirror image of the front shown in FIG. 2; FIG. 3 is a side elevational view thereof; FIG. 4 is an opposite side elevational view thereof; FIG. 5 is a top plan view thereof; and, FIG. 6 is a bottom plan view thereof.

1 Claim, 3 Drawing Sheets

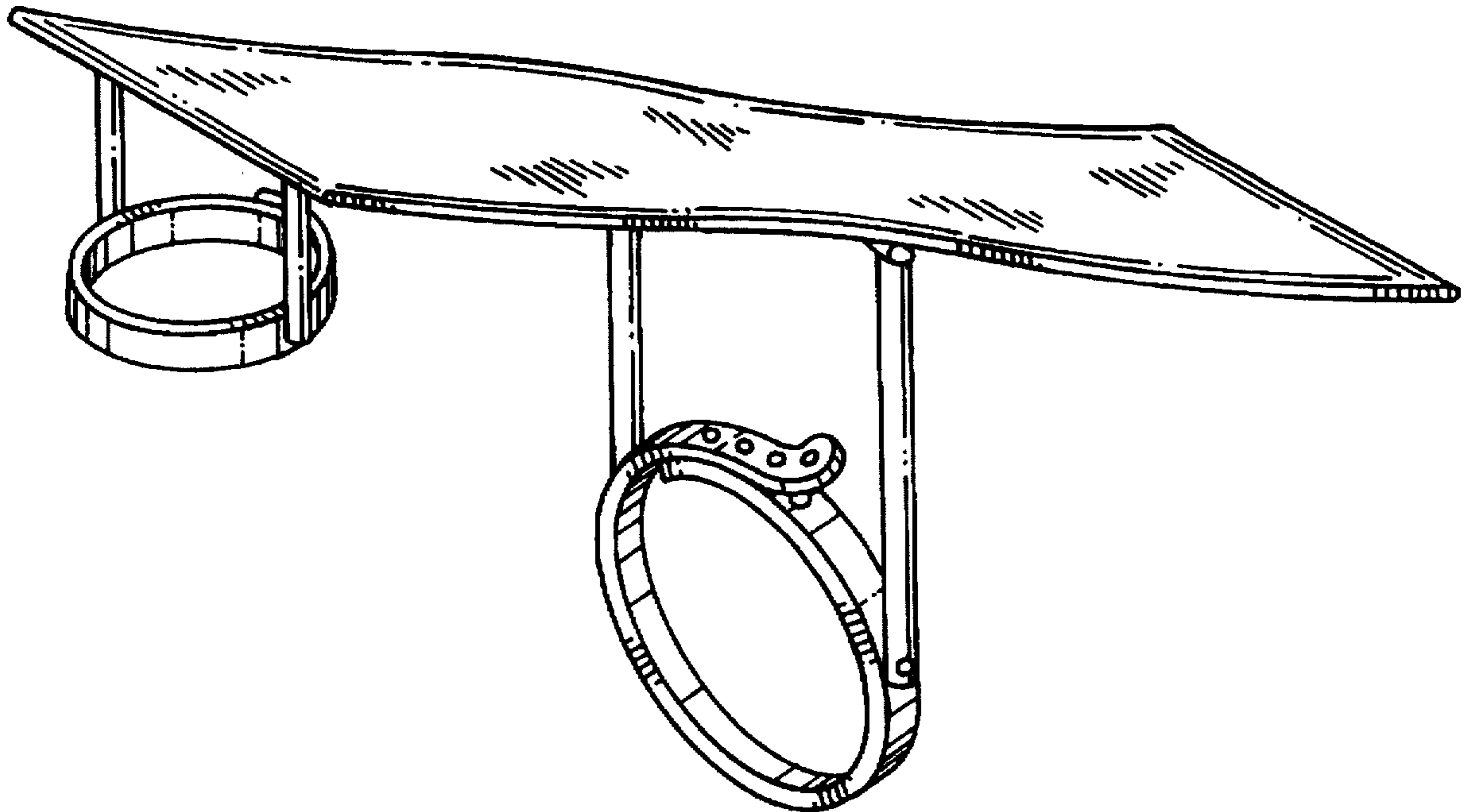

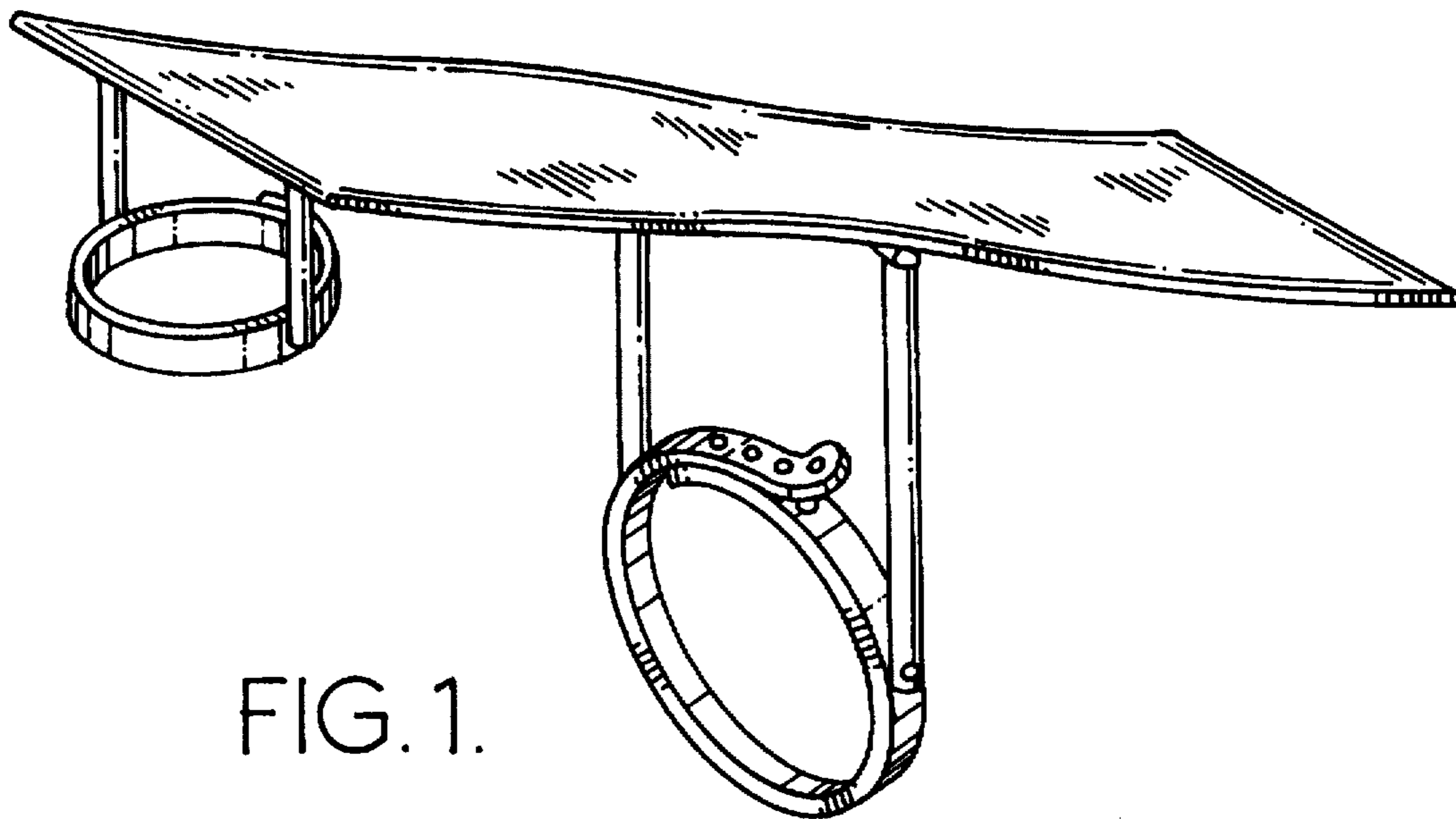

FIG. 1.

FIG. 2.

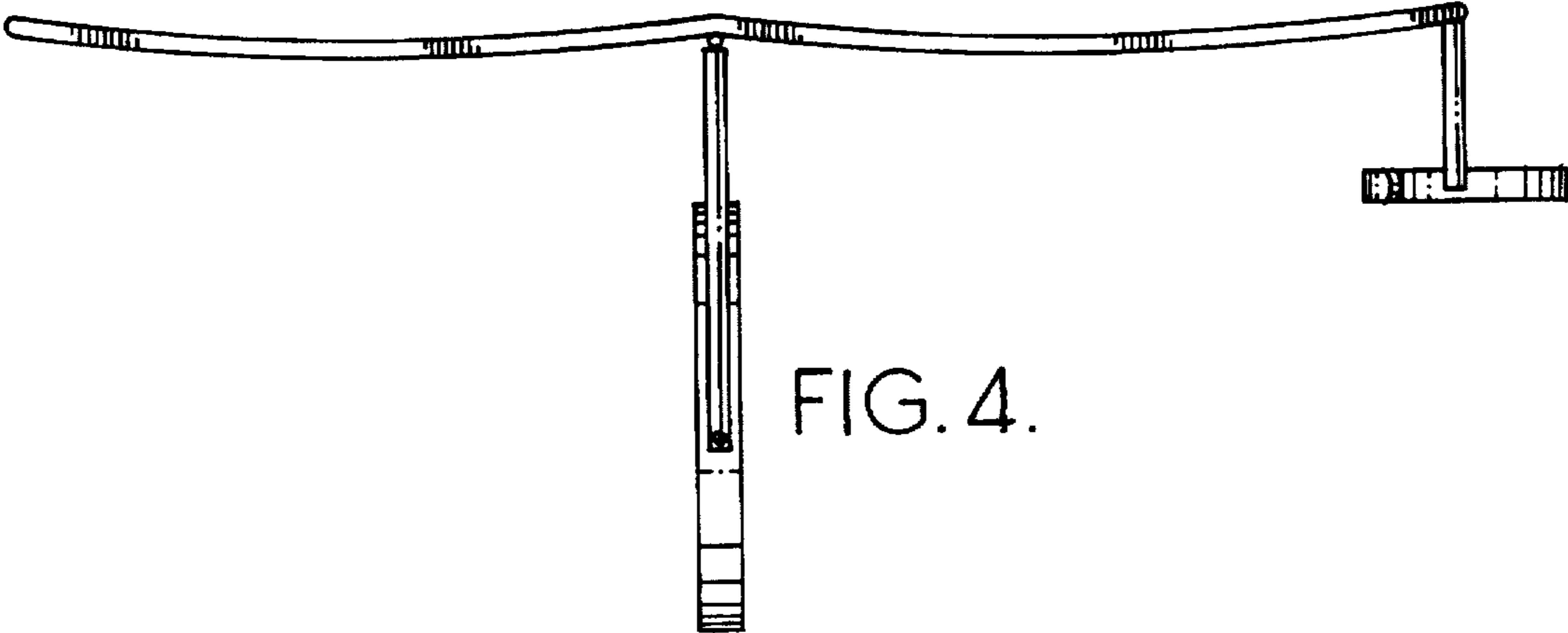
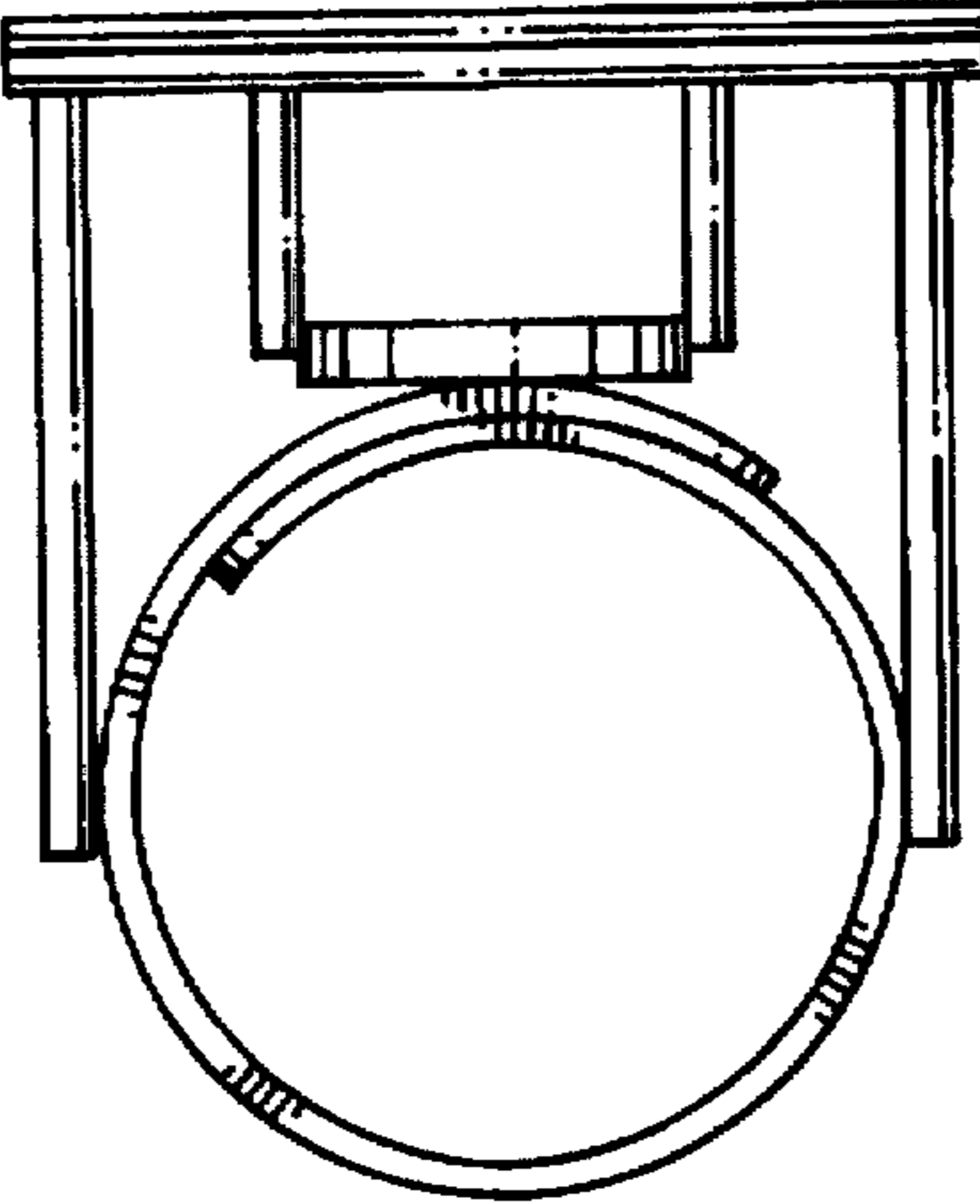

FIG. 4.

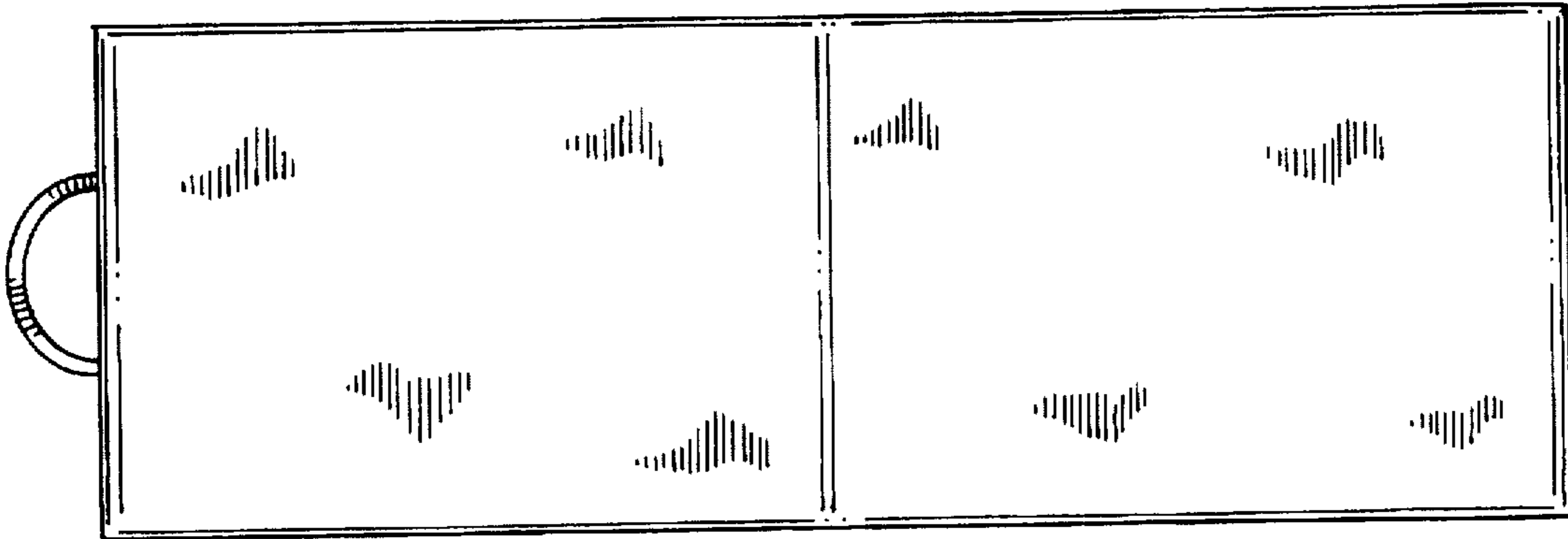

FIG. 5.

FIG. 3.

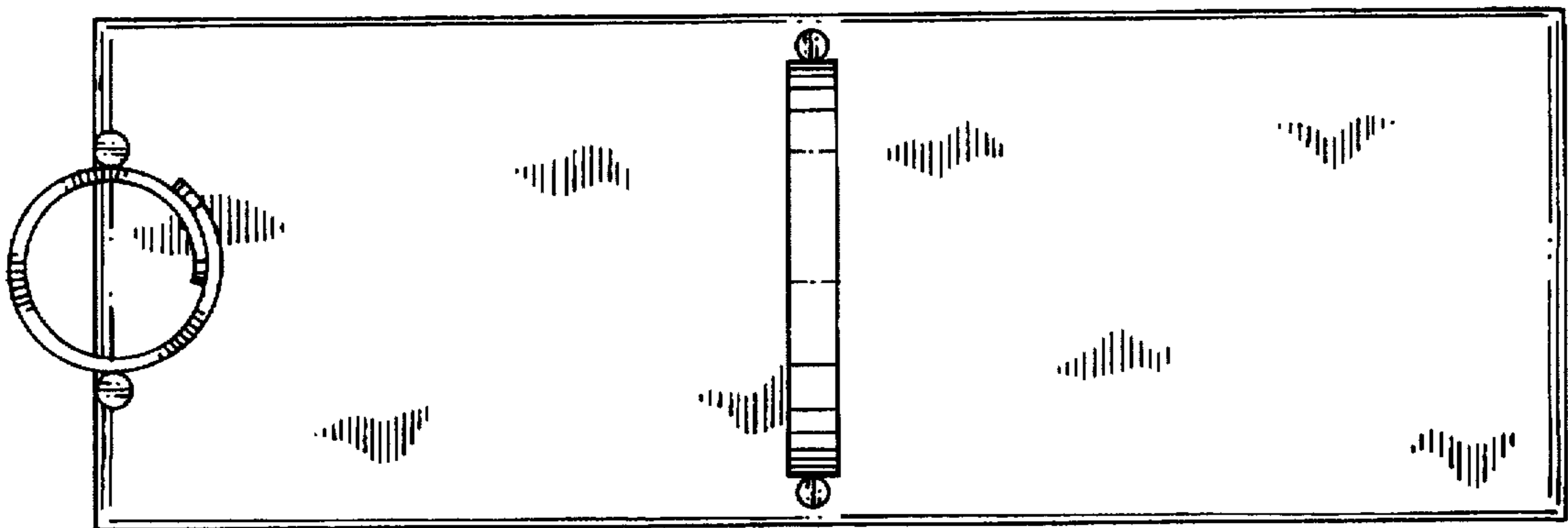
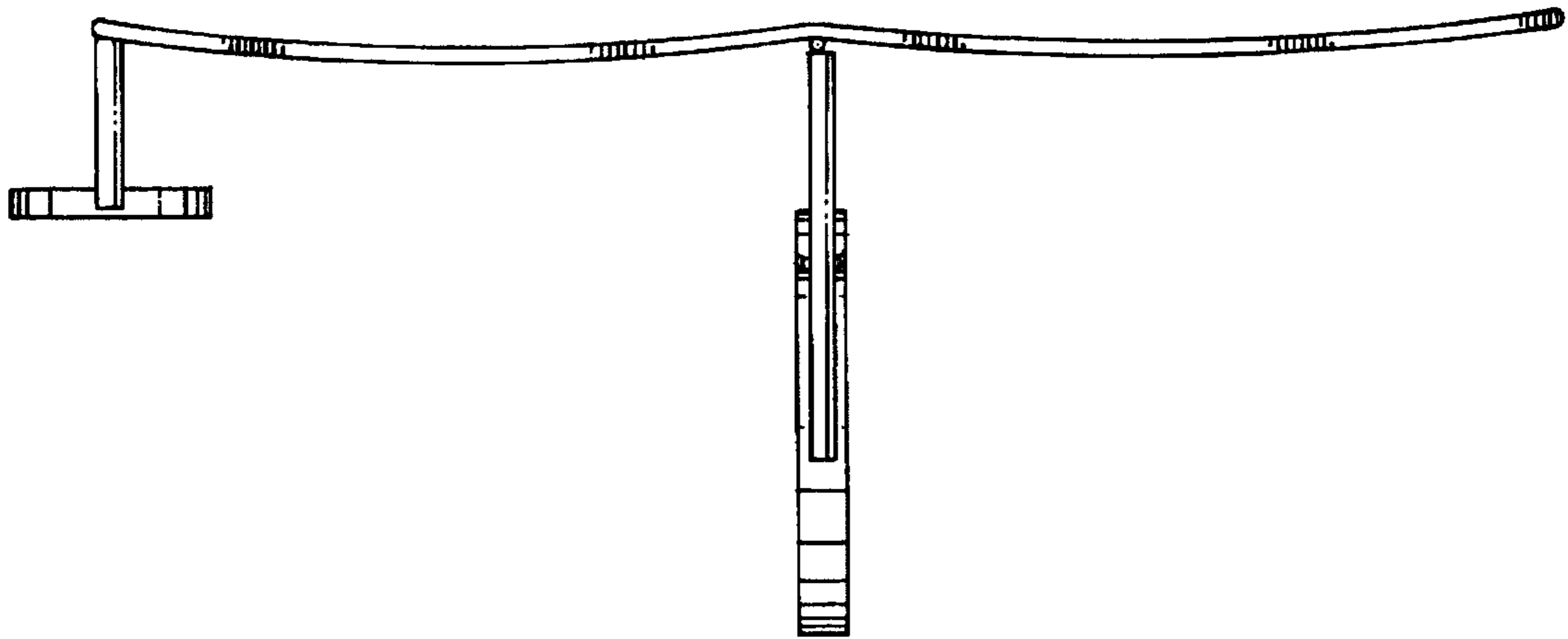

FIG. 6.