



US00D391388S

United States Patent [19]

[11] Patent Number: Des. 391,388

Higgins et al.

[45] Date of Patent: **Mar. 3, 1998

[54] HEAD CAP

[75] Inventors: Laura Higgins; Jerry Piotrowicz, both of Indianapolis, Ind.

[73] Assignee: Babesball Cap, Inc., Belize, Belize

[**] Term: 14 Years

[21] Appl. No.: 47,110

[22] Filed: Nov. 24, 1995

[51] LOC (6) Cl. 02-03

[52] U.S. Cl. D2/882

[58] Field of Search D2/865, 866, 868, D2/869, 872, 873, 876, 879, 882, 884, 886, 893; 2/171, 171.3, 171.1, 171.7, 181, 181.6, 195.1, 195.2, 195.7, 175.1, 175.3

[56] References Cited

U.S. PATENT DOCUMENTS

D. 363,157	10/1995	Rodgers	D2/866
970,894	9/1910	Davies	2/171.3
1,190,427	7/1916	Kromer, Jr.	2/181
1,562,990	11/1925	Rappaport	2/181 X
2,686,918	8/1954	Beighton	2/181
3,735,423	5/1973	Droz	2/171.3
4,131,953	1/1979	Kimotsuki	2/171.3 X
5,321,854	6/1994	Kronenberger	2/195.1 X
5,509,145	4/1996	Stevenson et al.	2/171.1 X
5,511,249	4/1996	Higgins	2/195.1 X

Primary Examiner—Paula A. Mortimer
Attorney, Agent, or Firm—Robert A. Spray

[57] CLAIM

The ornamental design for head cap, as shown and described.

DESCRIPTION

FIG. 1 is a front elevation view thereof;

FIG. 2 is a rear elevation view thereof;

FIG. 3 is a view looking upward toward the interior of the cap;

FIG. 4 is a top plan view thereof;

FIG. 5 is a left side elevation view;

FIG. 6 is a right side elevation view;

FIG. 7 is a fragmentary exterior view taken along line 7—7 of FIG. 2;

FIG. 8 is a front elevation view thereof;

FIG. 9 is a rear elevation view thereof;

FIG. 10 is a view looking upward toward the interior of the cap;

FIG. 11 is a top plan view thereof;

FIG. 12 is a left side elevation view;

FIG. 13 is a right side elevation view;

FIG. 14 is a fragmentary exterior view taken along line 14—14 of FIG. 9;

FIG. 15 is a front elevation view thereof;

FIG. 16 is a rear elevation view thereof;

FIG. 17 is a view looking upward toward the interior of the cap;

FIG. 18 is a top plan view thereof;

FIG. 19 is a left side elevation view;

FIG. 20 is a right side elevation view; and

FIG. 21 is a fragmentary exterior view taken along line 21—21 of FIG. 16.

1 Claim, 9 Drawing Sheets

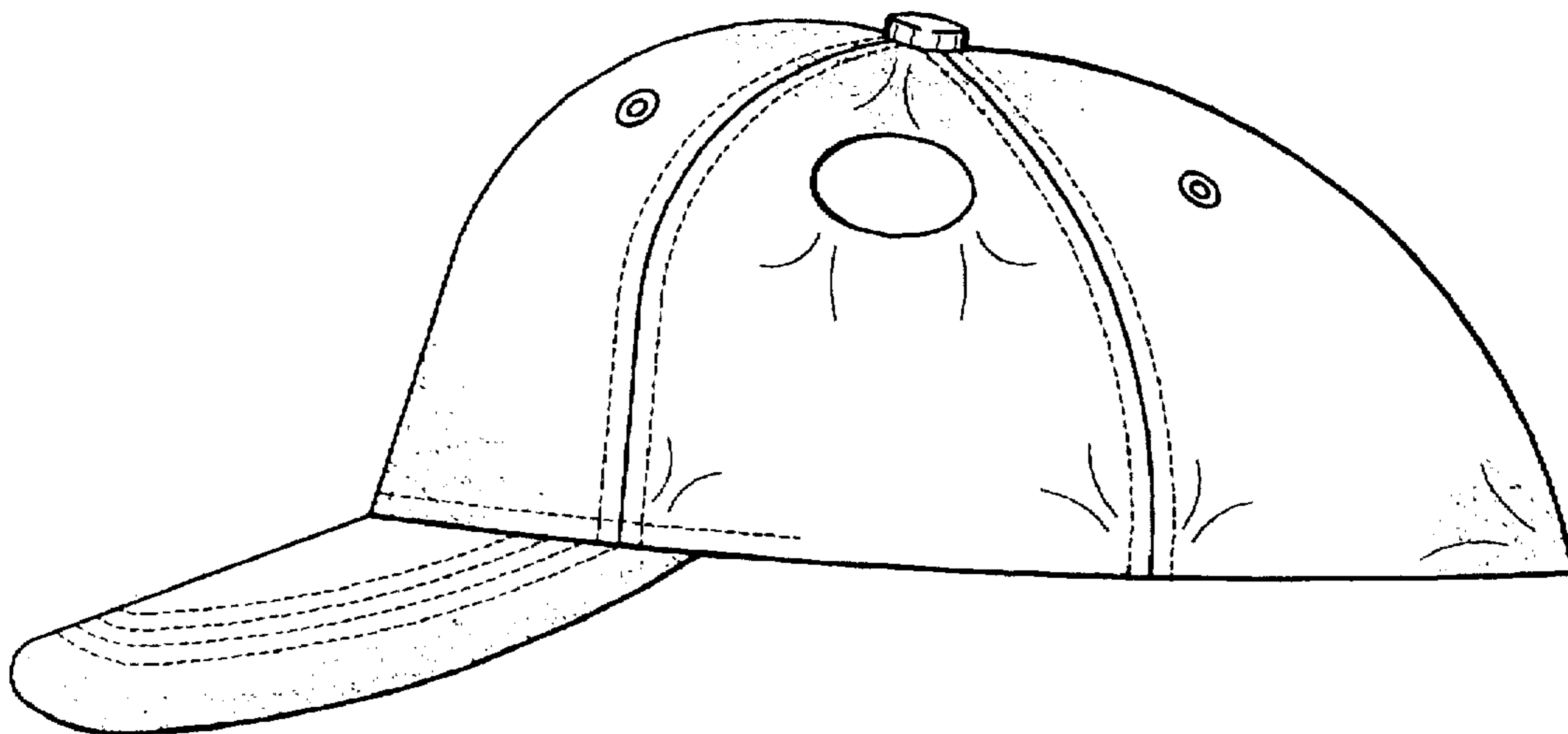

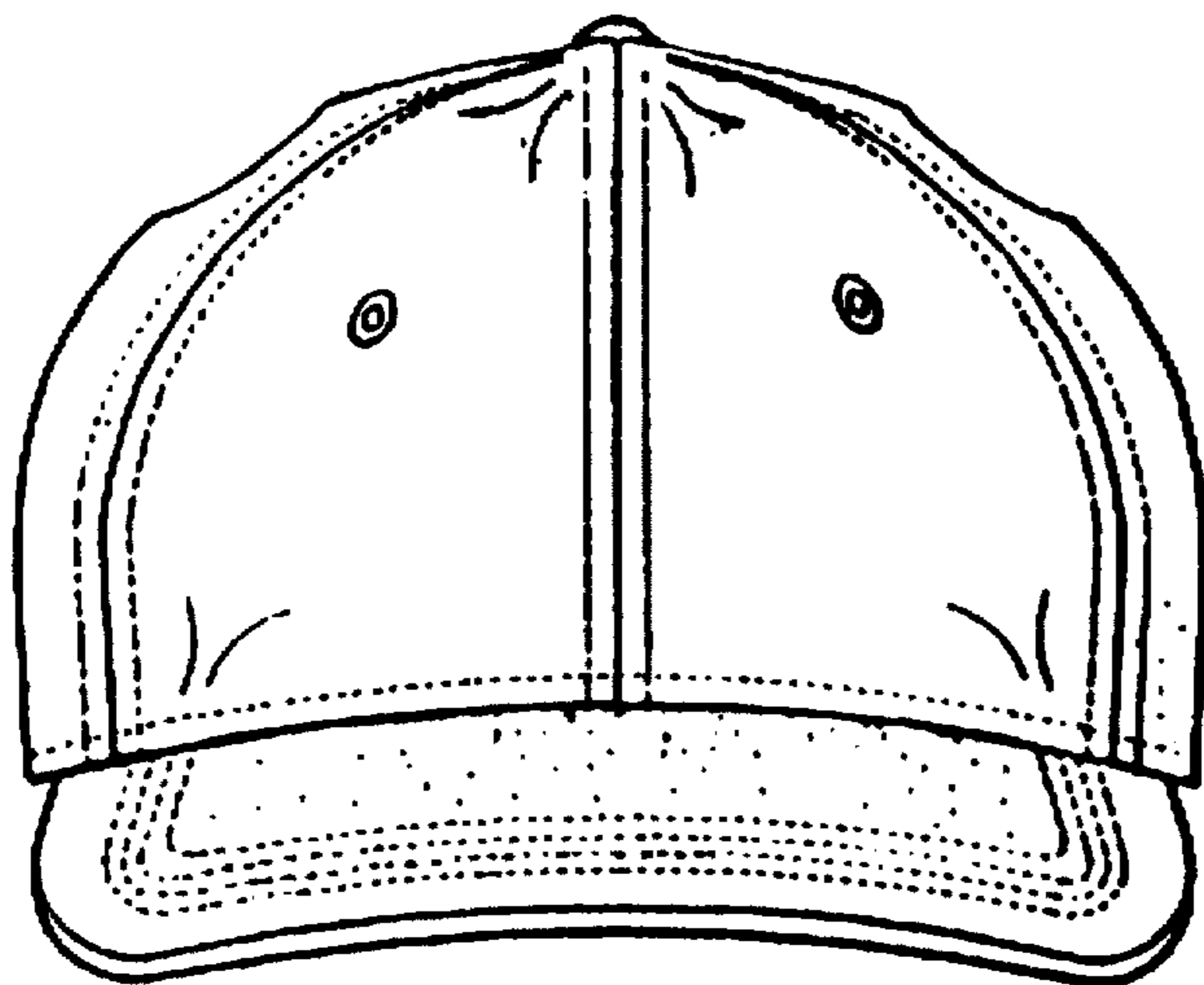

Fig. 1

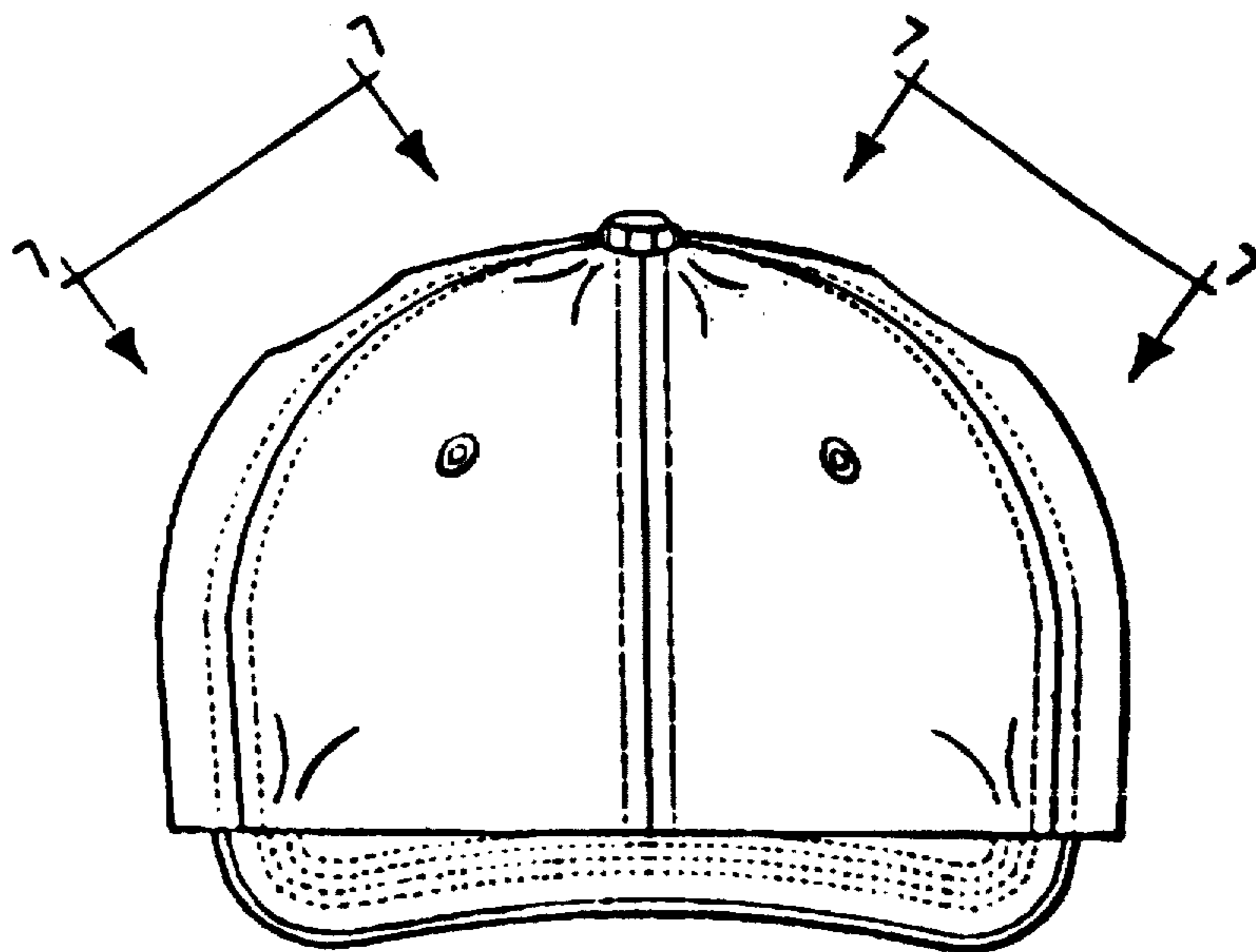

Fig. 2

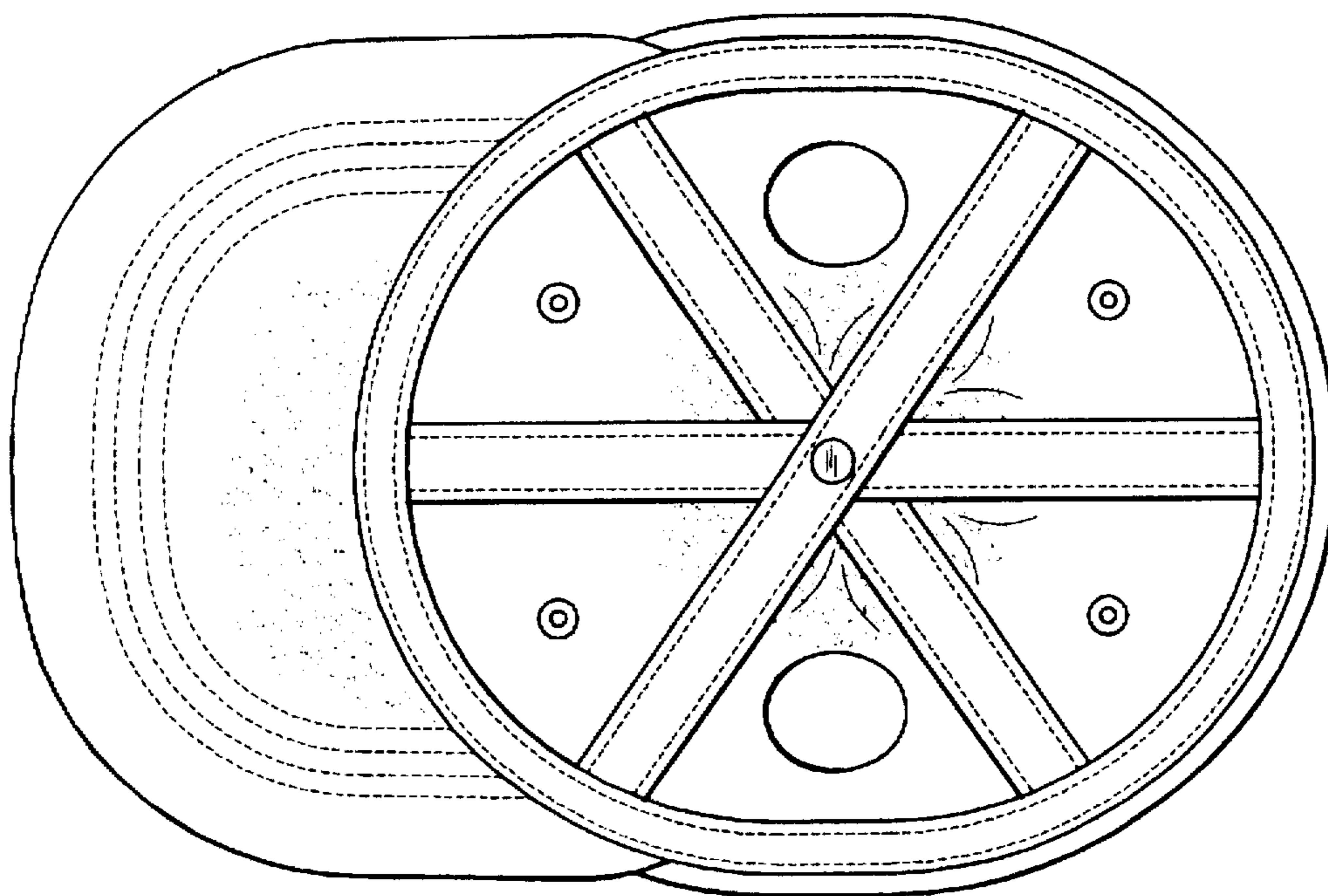

Fig. 3

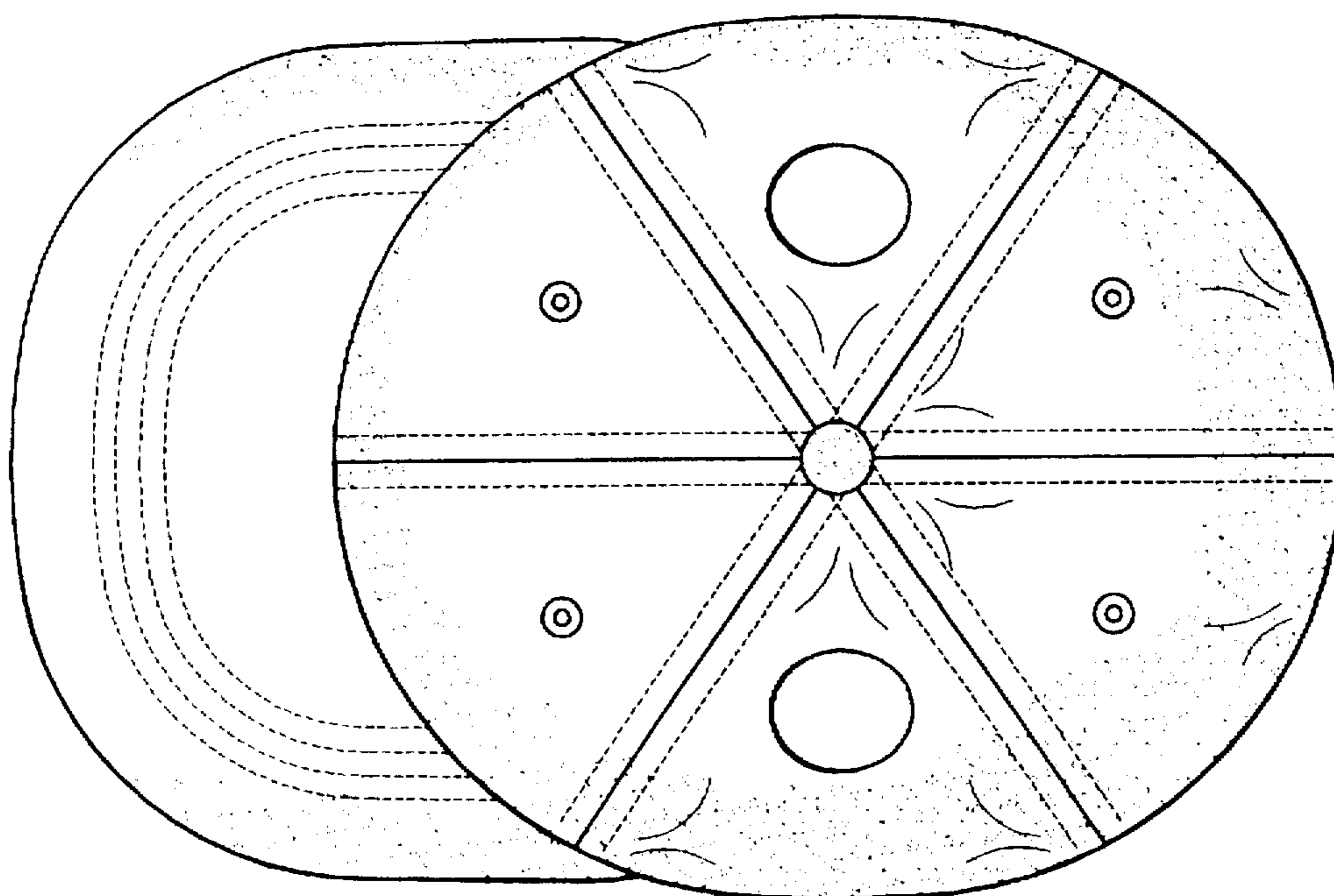

Fig. 4

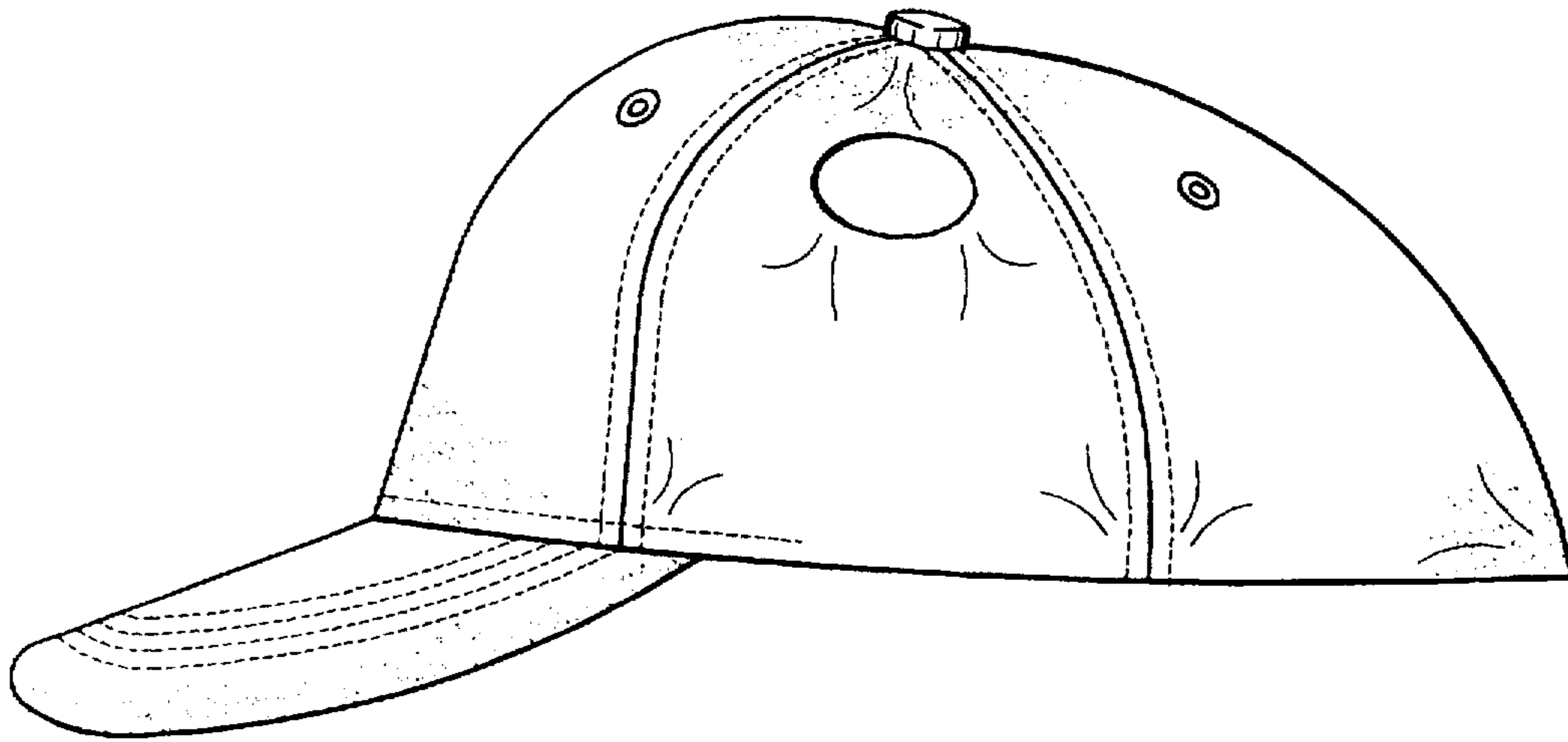

Fig. 5

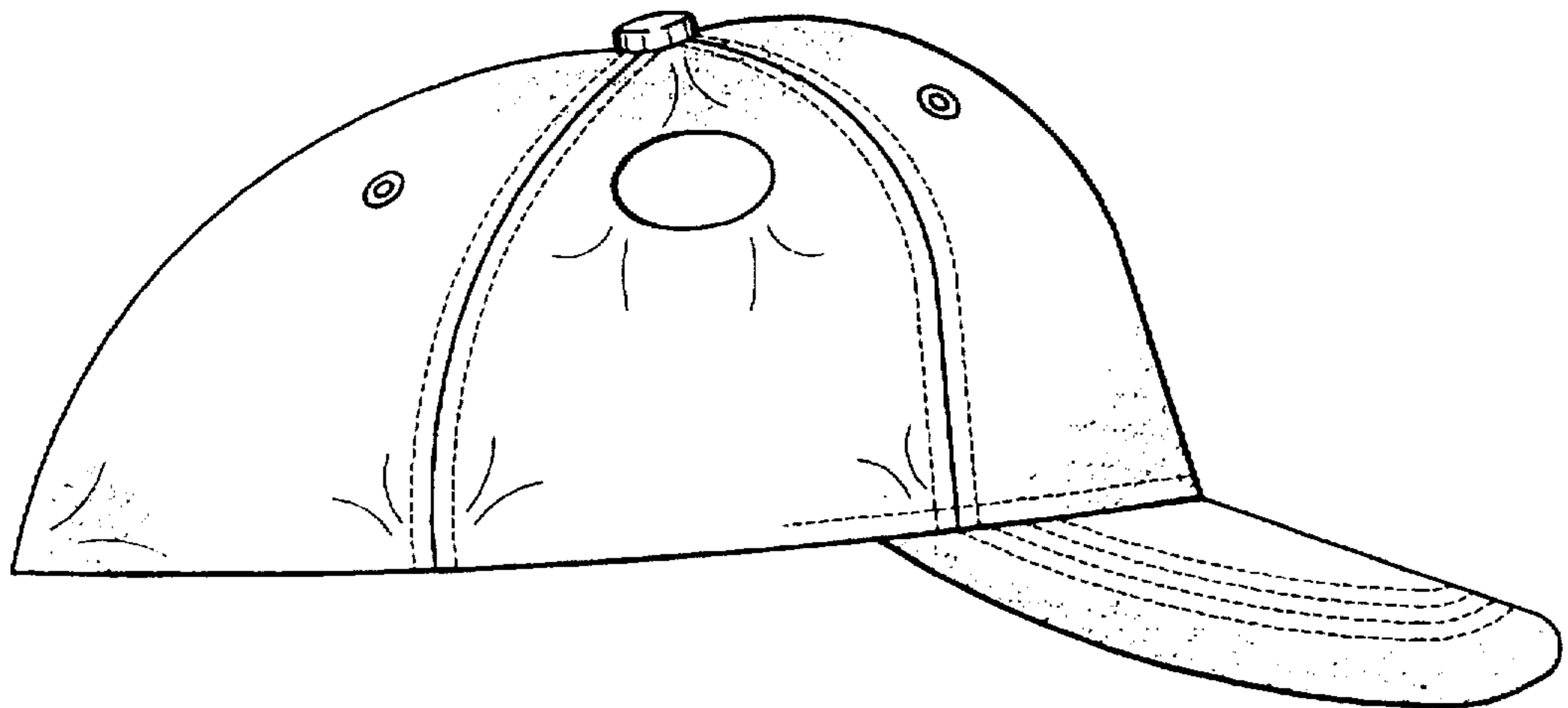

Fig. 6

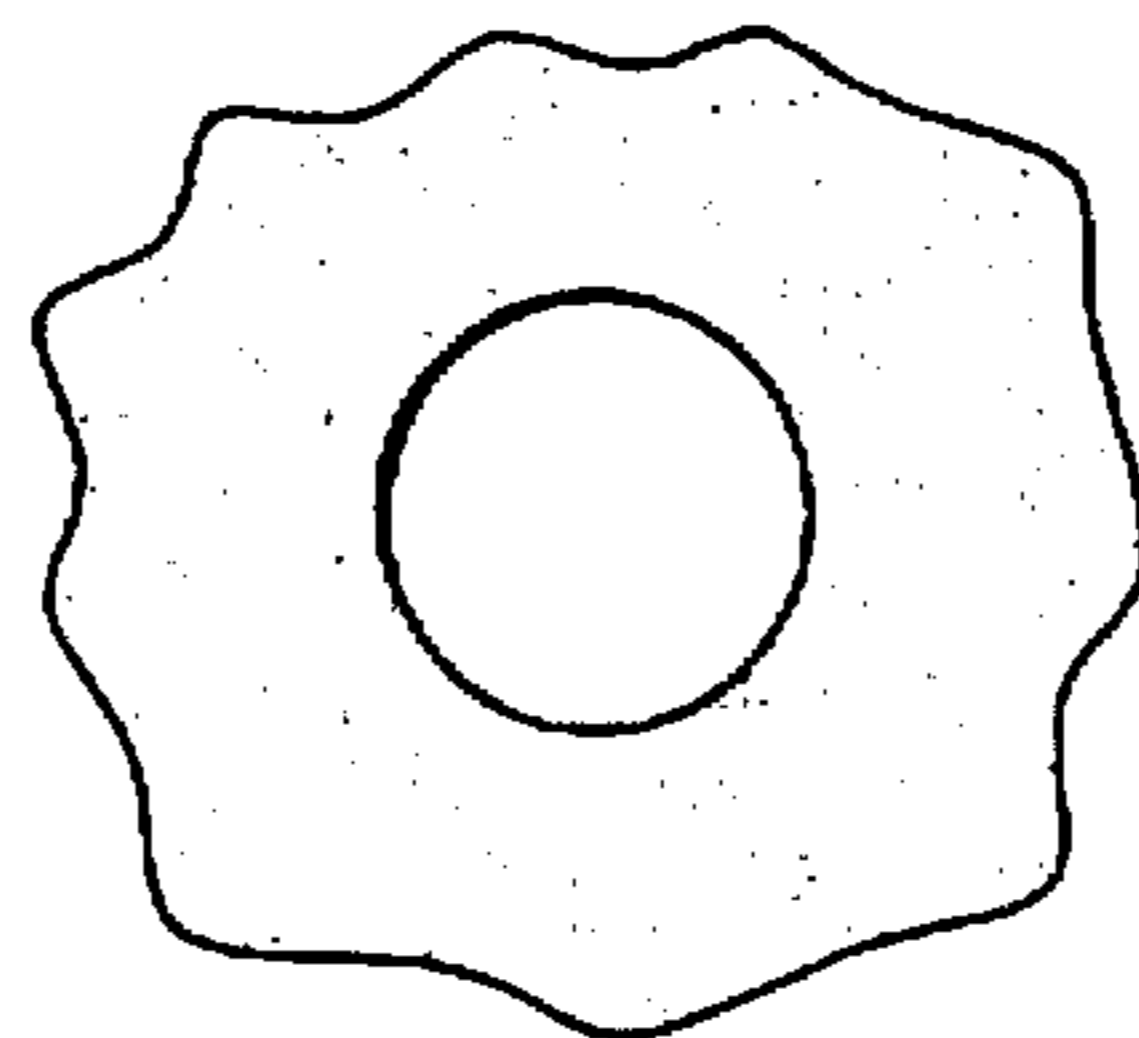

Fig. 7

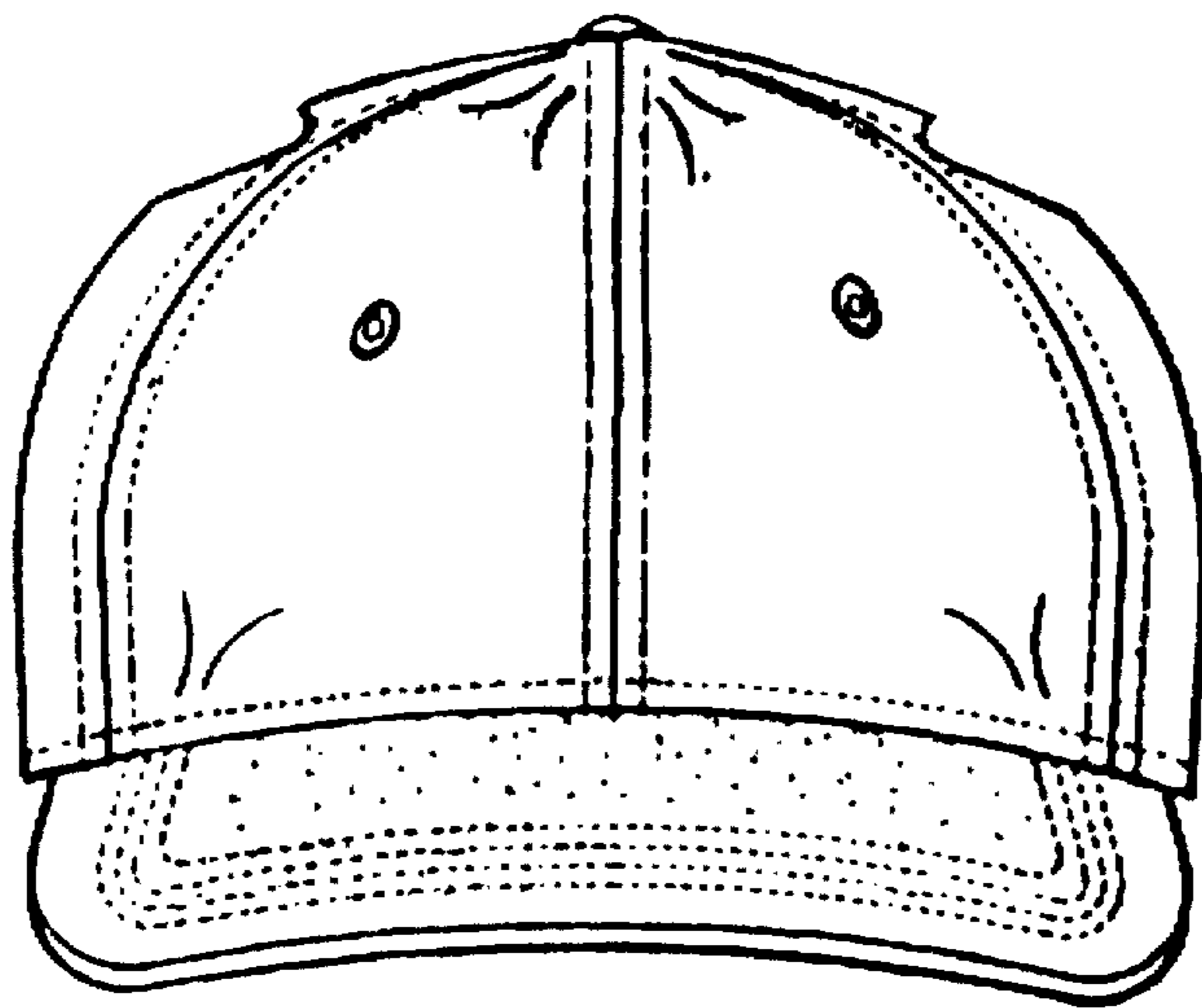

Fig. 8

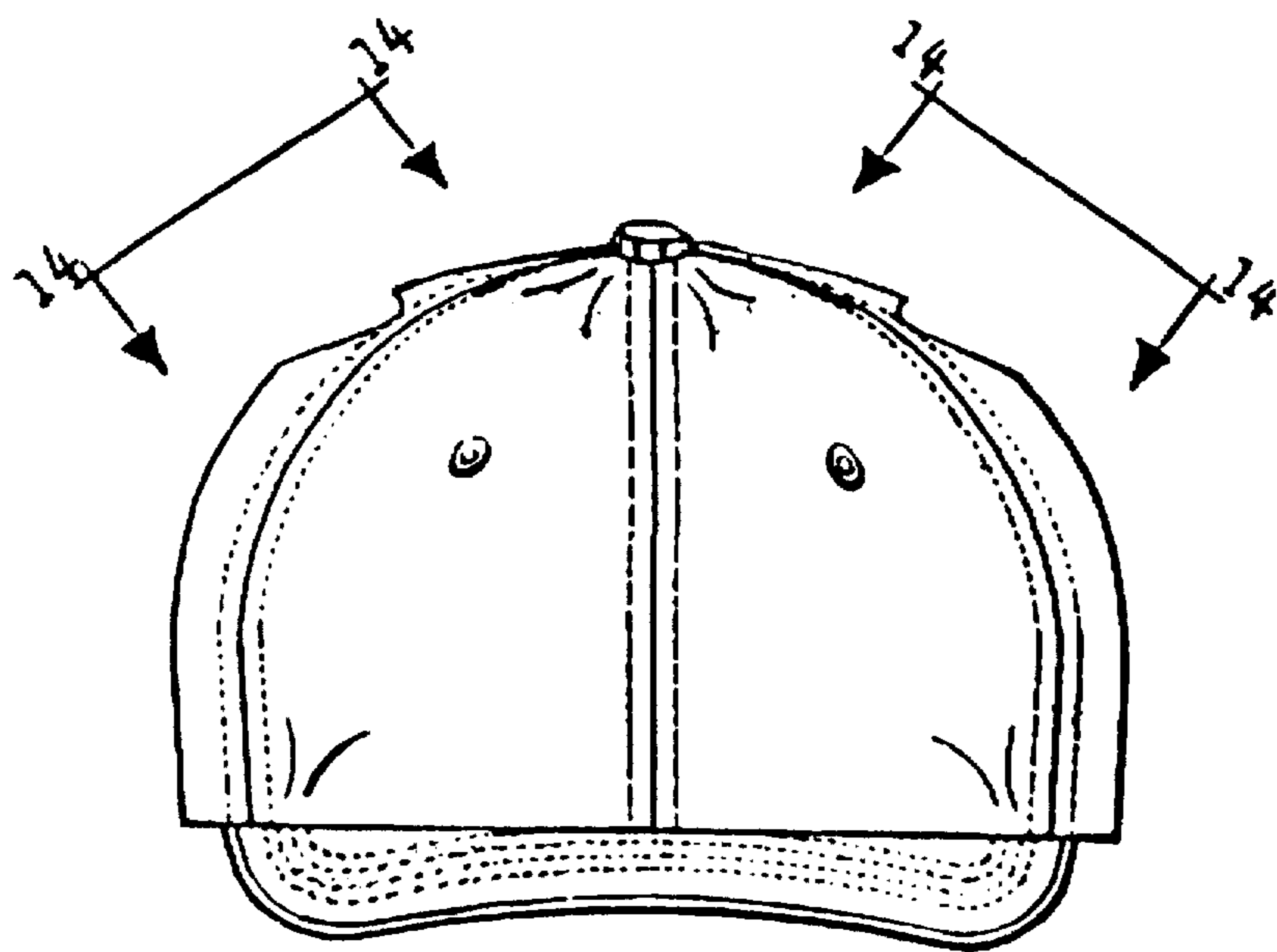

Fig. 9

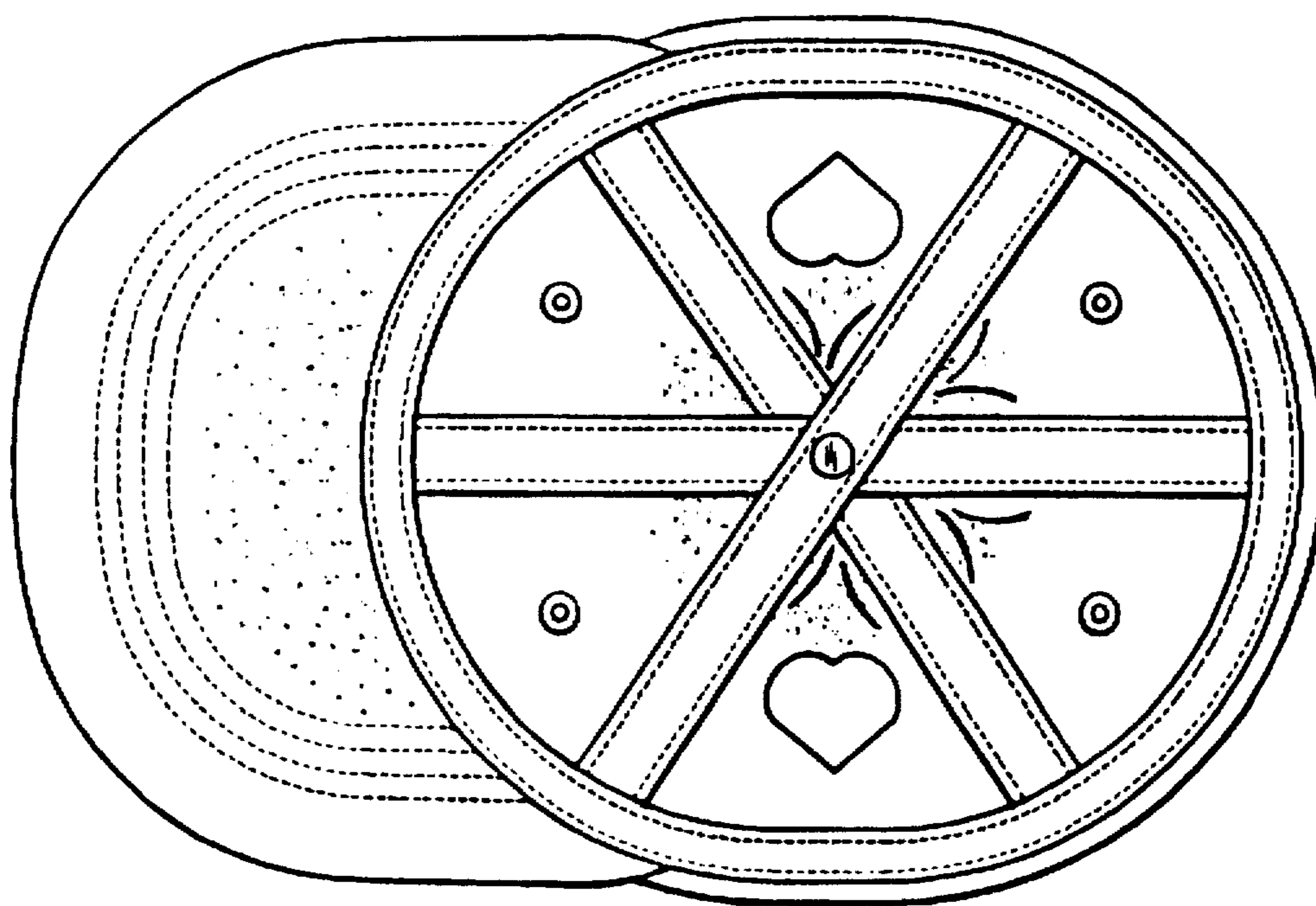

Fig. 10

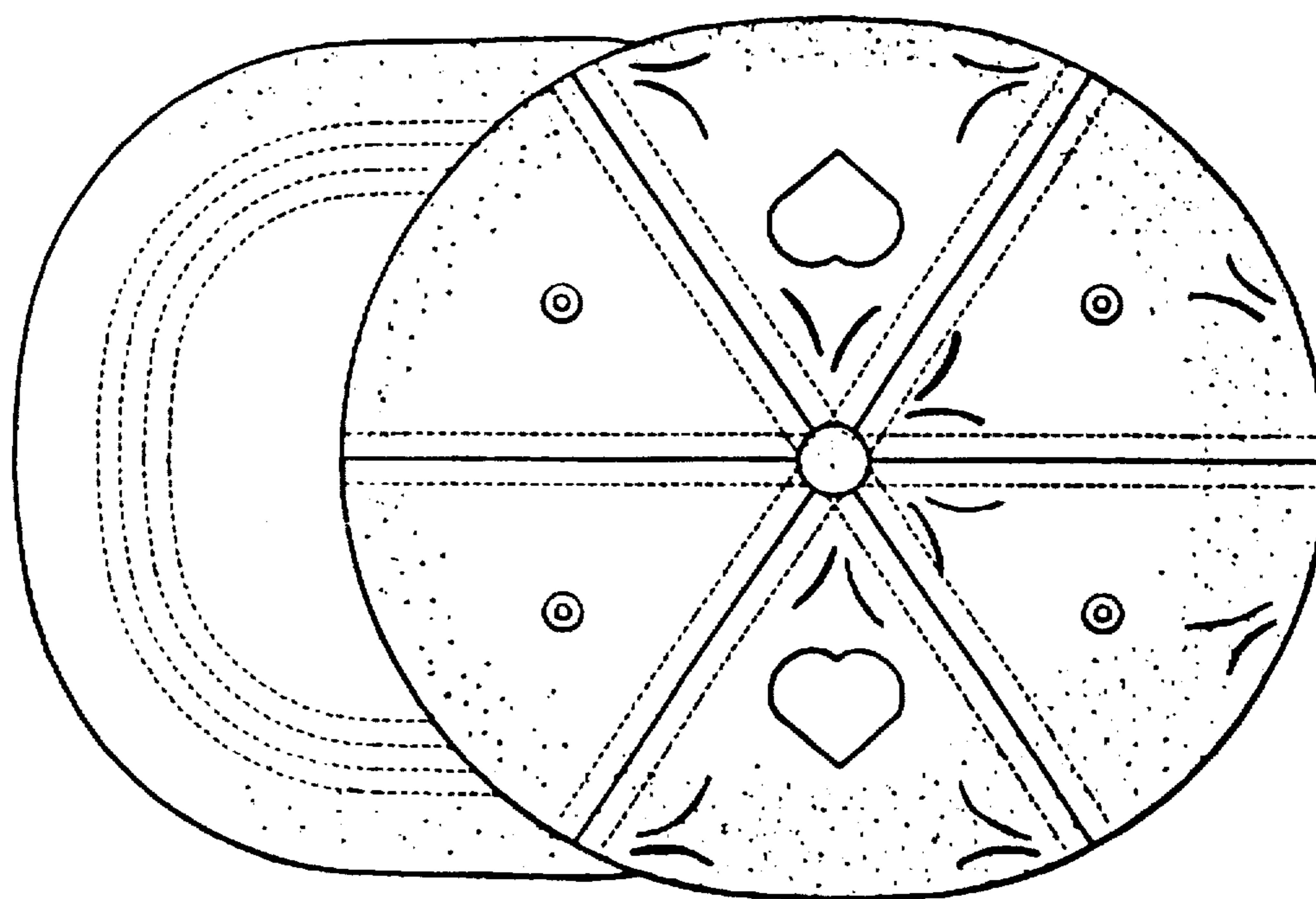

Fig. 11

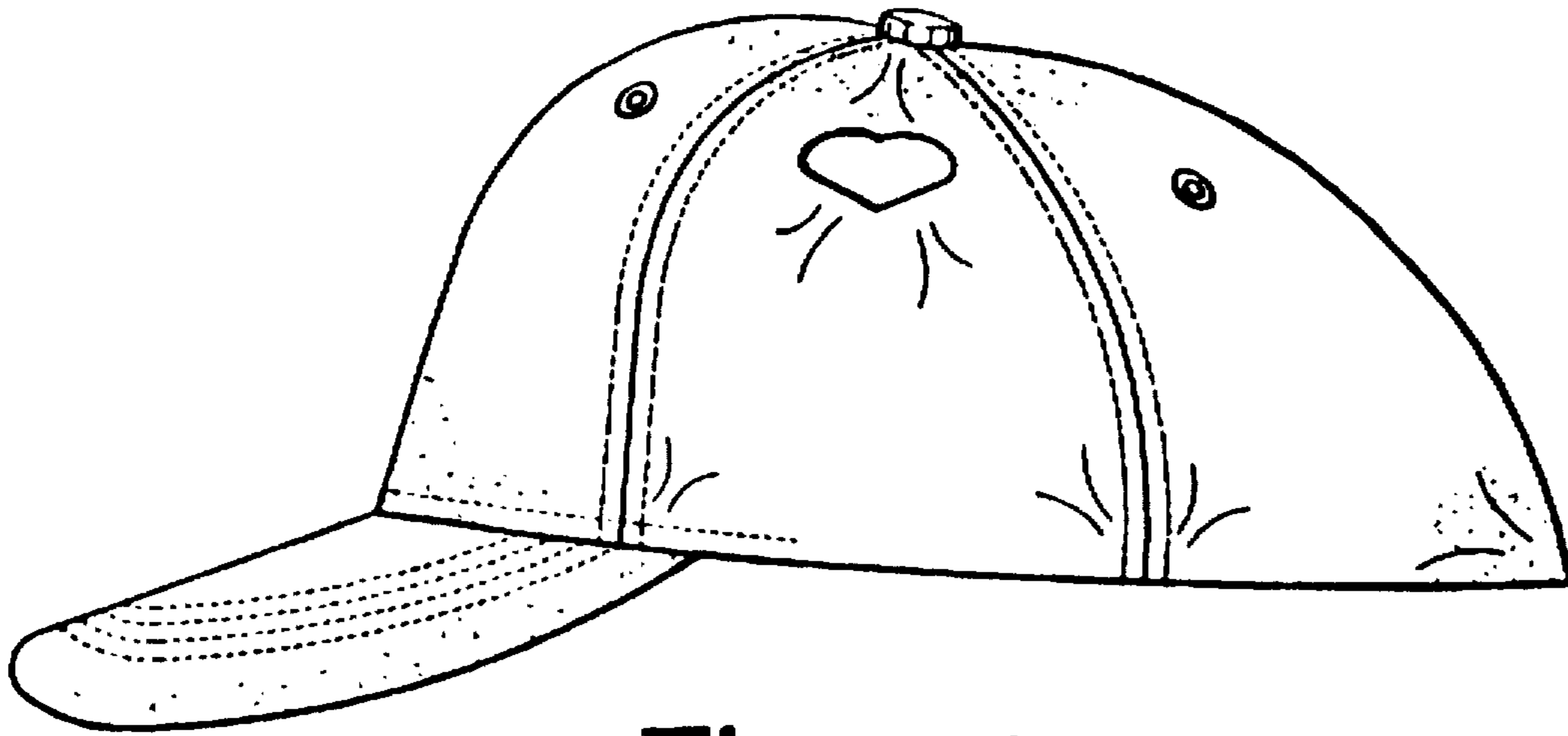

Fig. 12

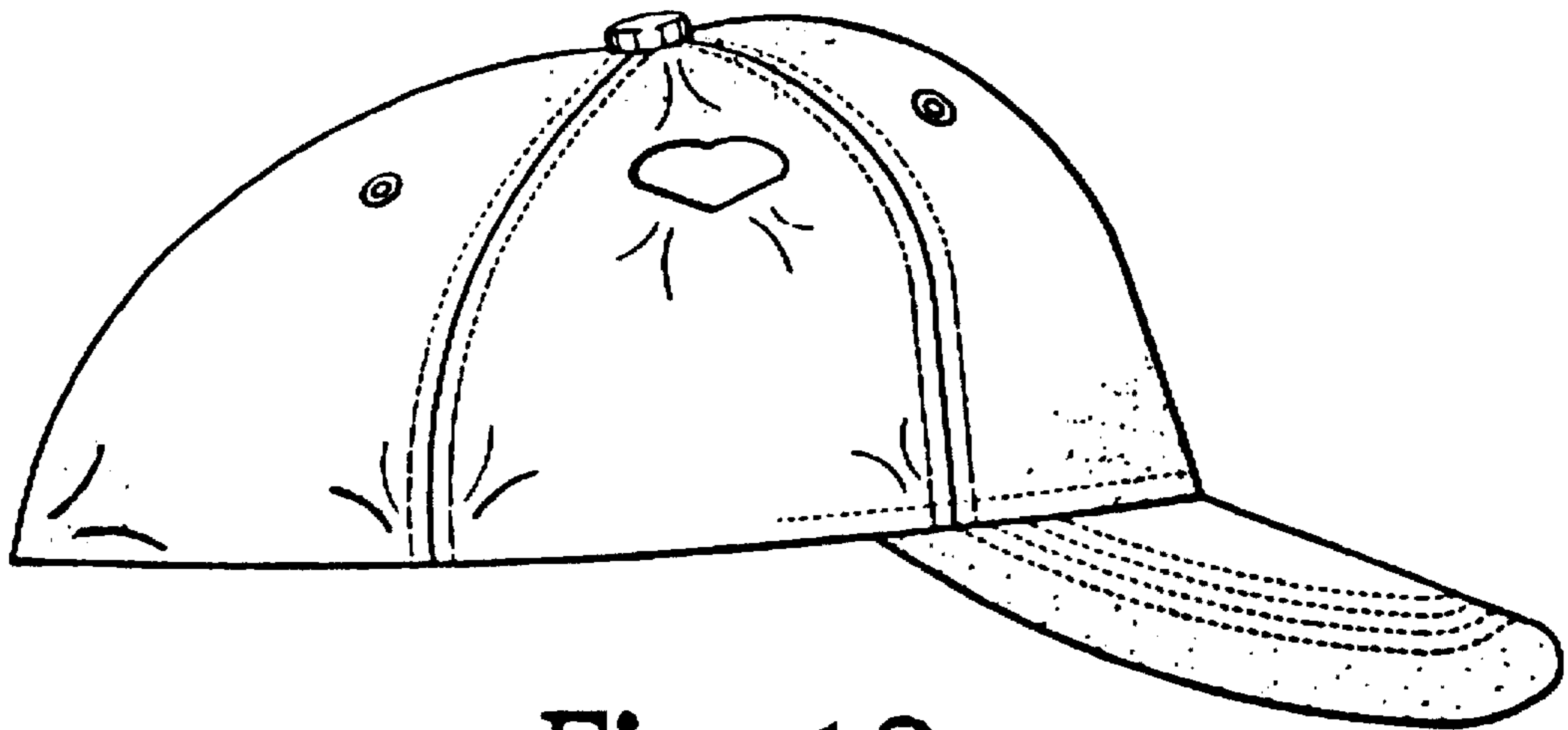

Fig. 13

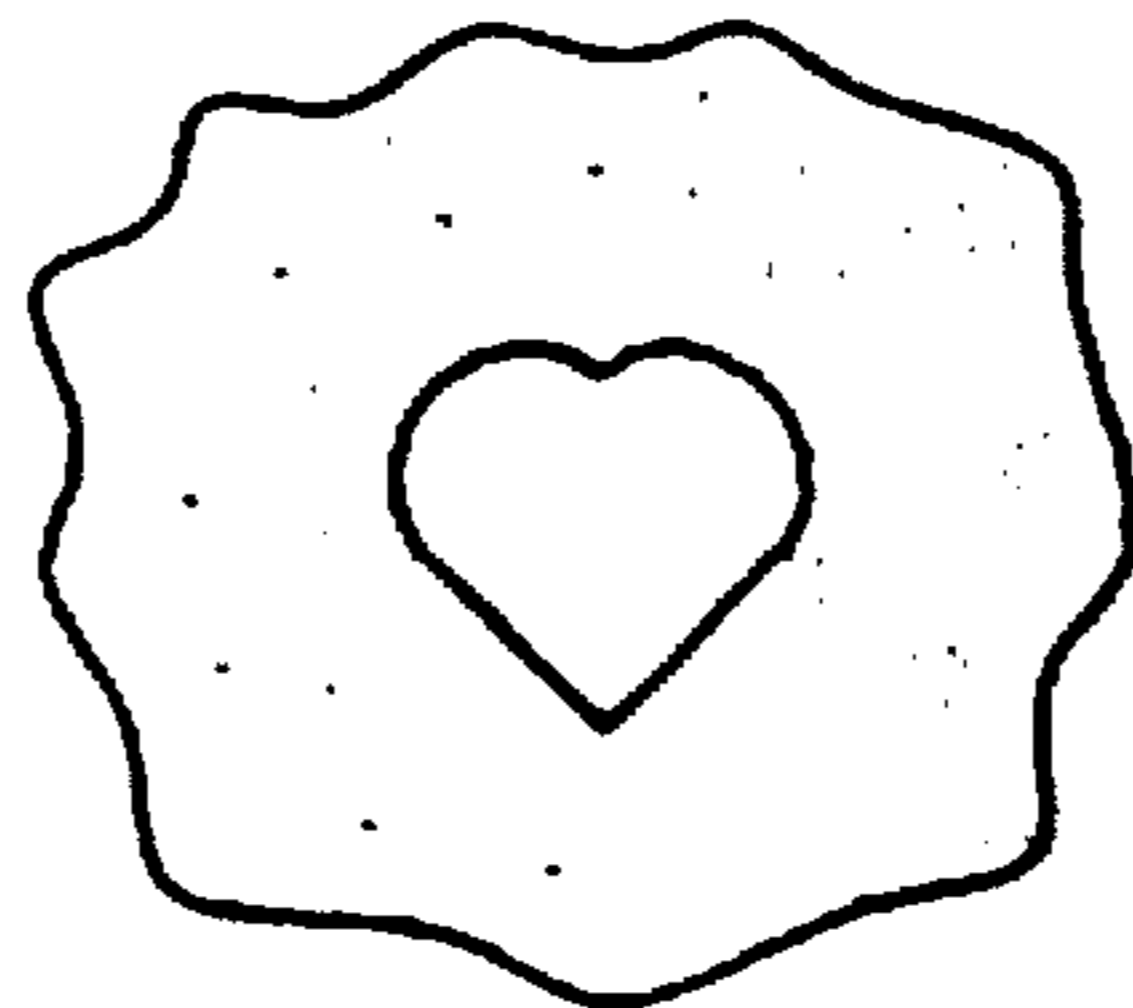

Fig. 14

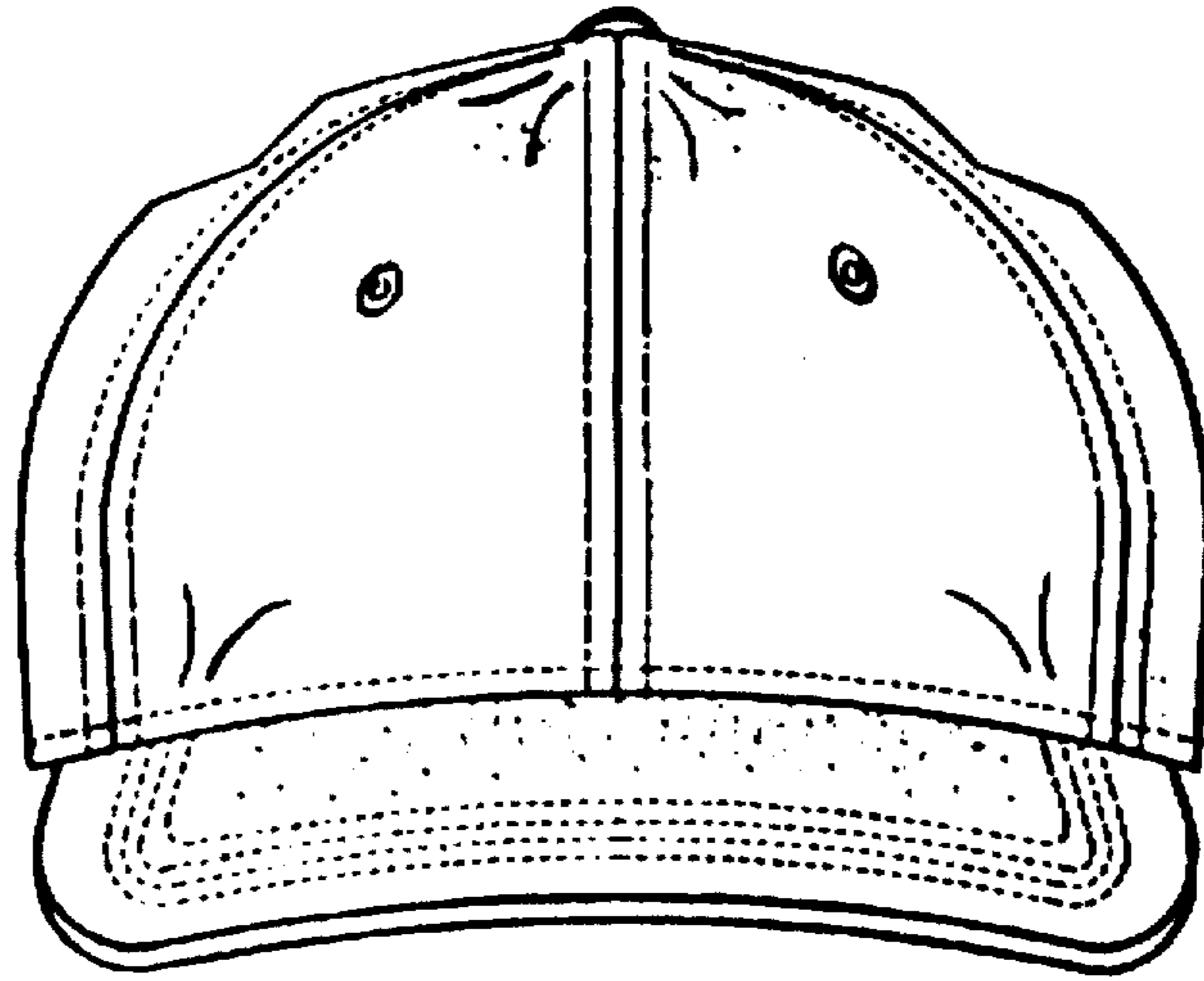

Fig. 15

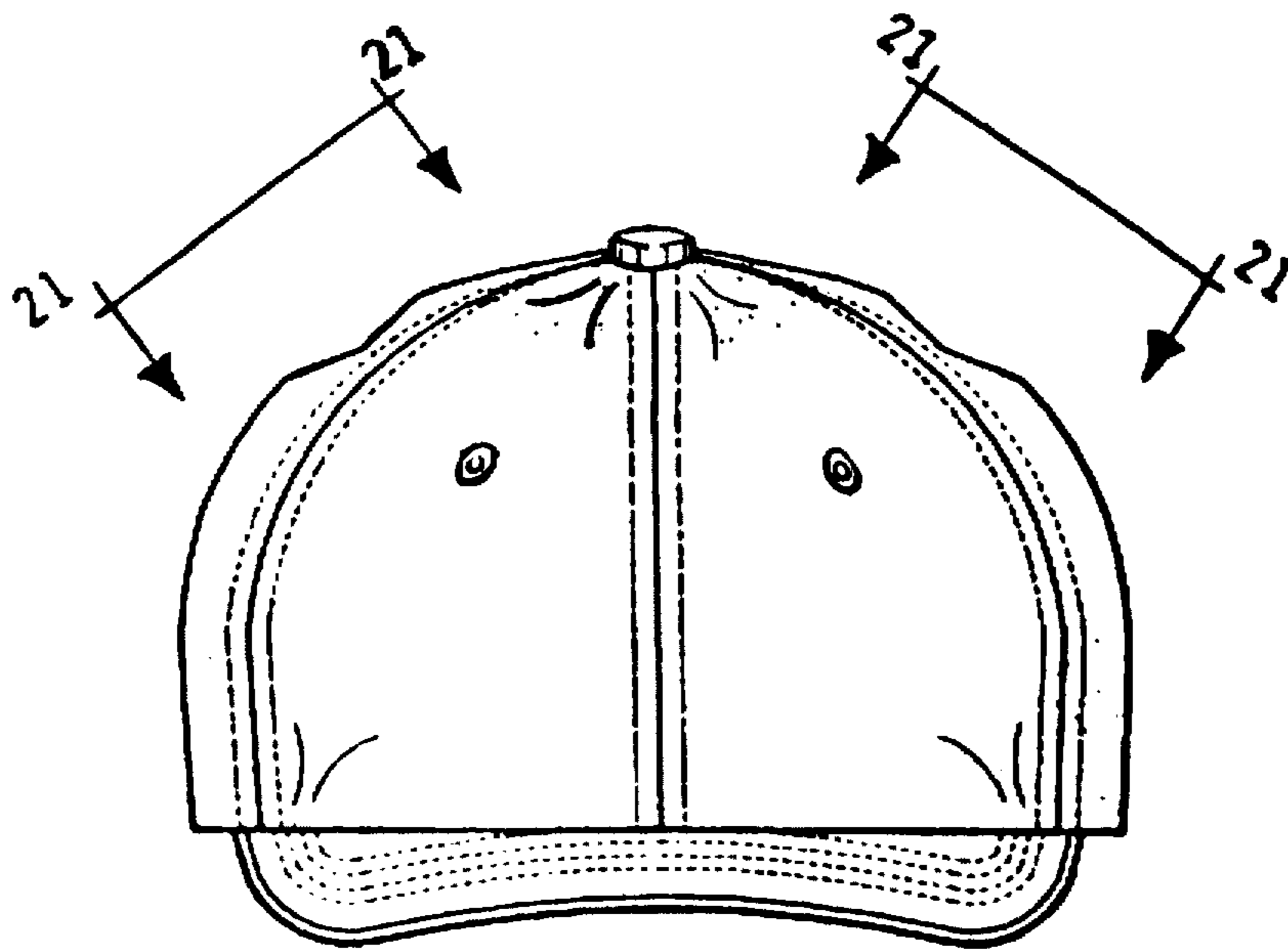

Fig. 16

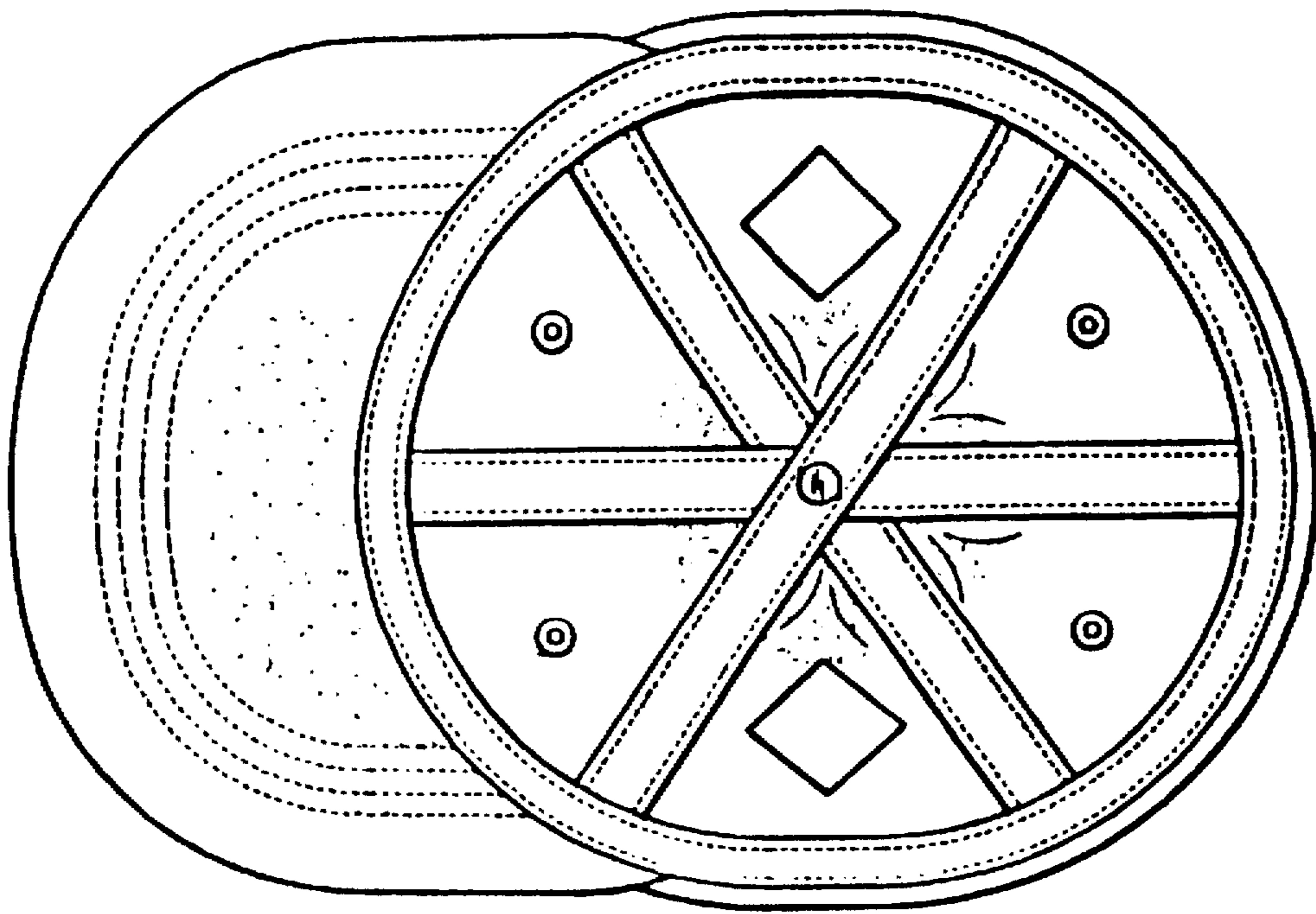

Fig. 17

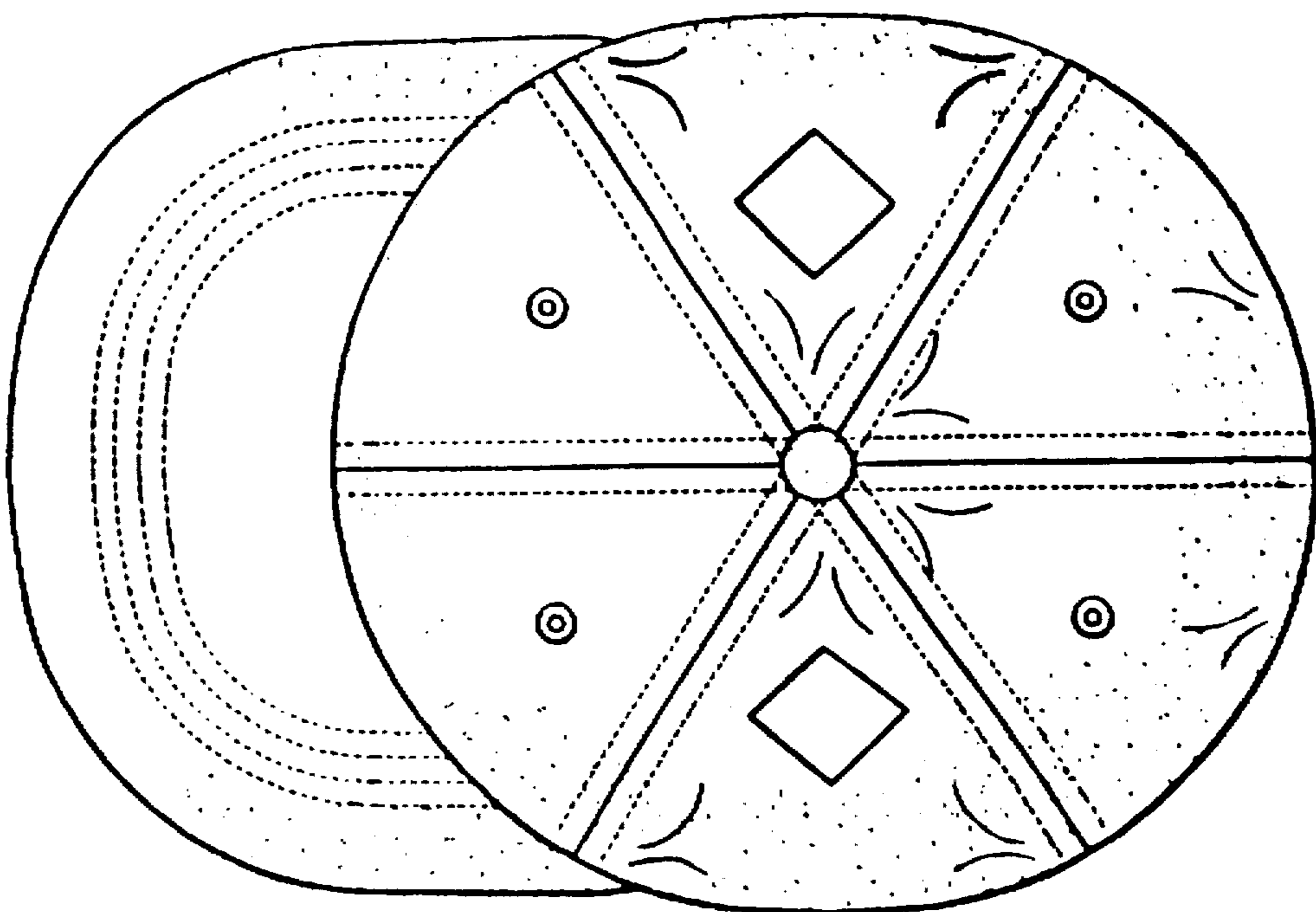

Fig. 18

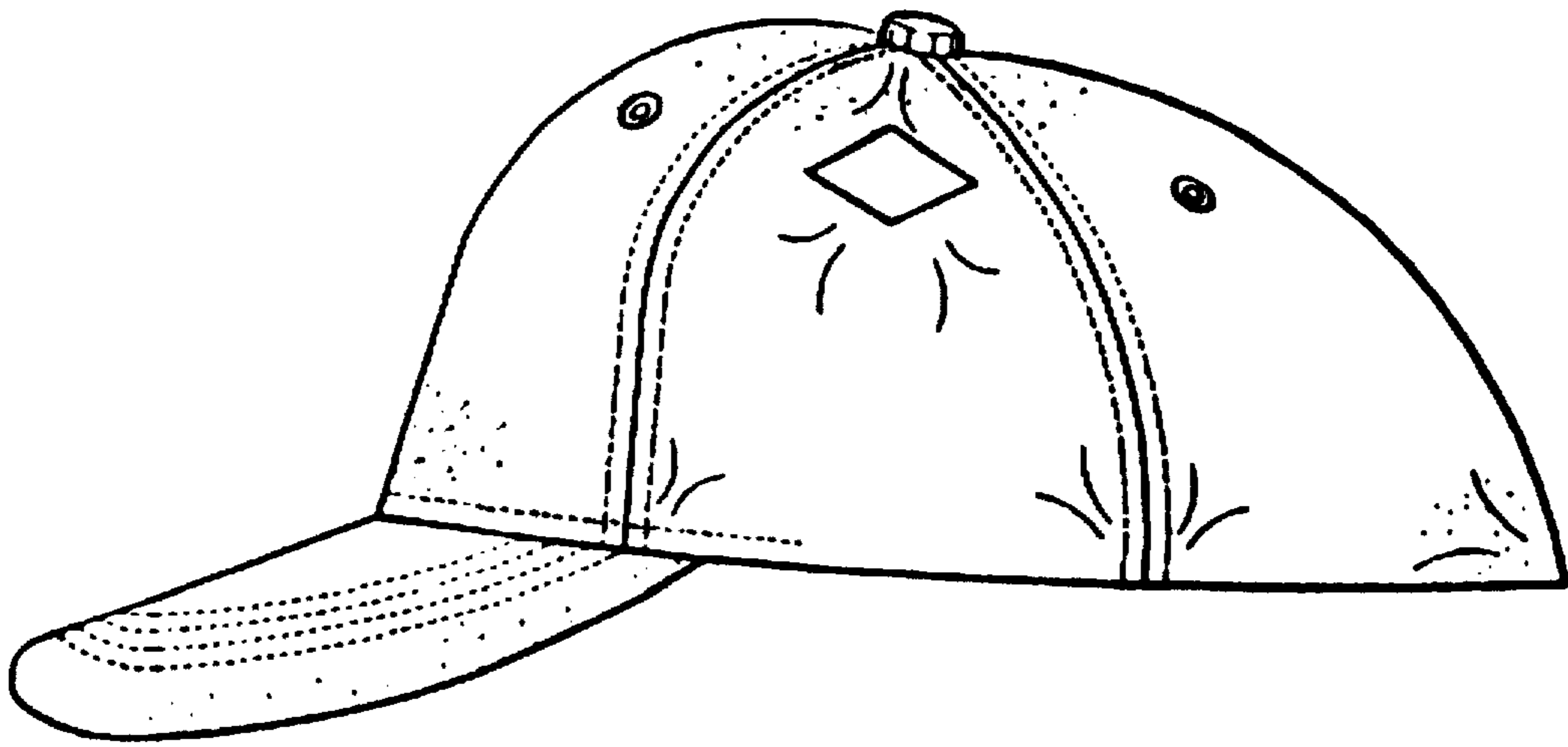

Fig. 19

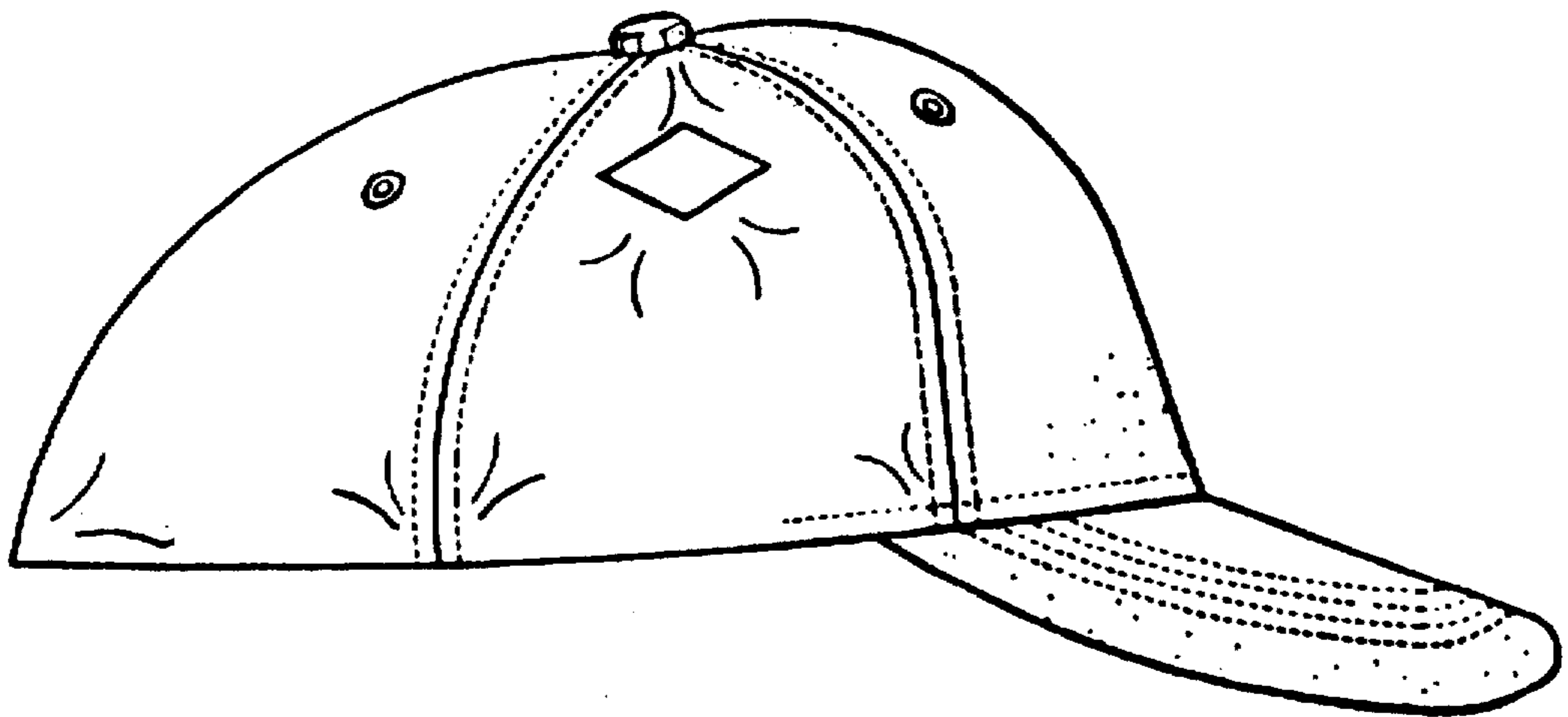

Fig. 20

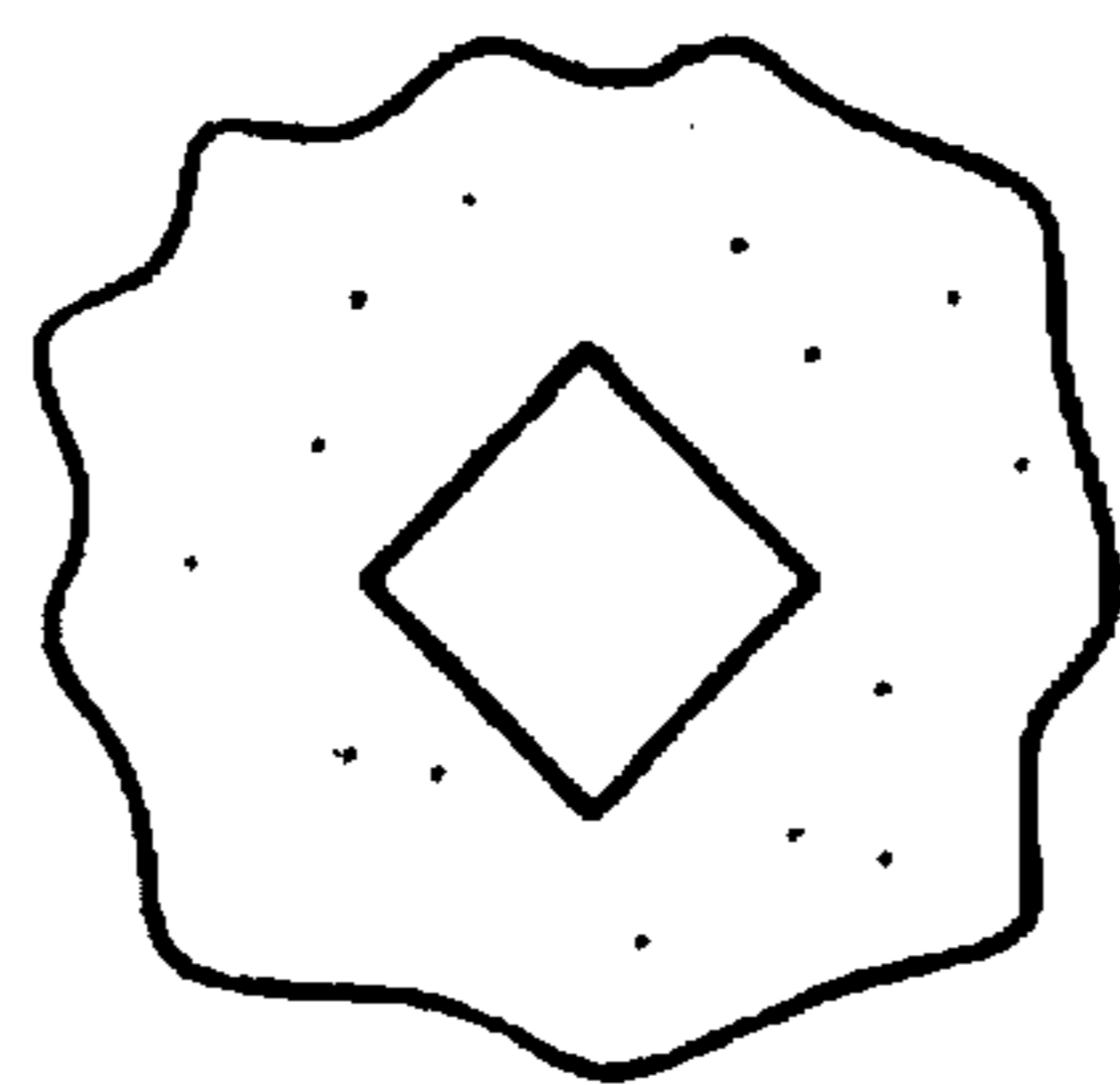

Fig. 21