



US00D391371S

United States Patent [19]
Coakley

[11] **Patent Number: Des. 391,371**
[45] **Date of Patent: **Feb. 24, 1998**

[54] **CARDIOPULMONARY RESUSCITATION
PILLOW**

5,441,479 8/1995 Chitwood 602/18
5,634,222 6/1997 Zwickey 5/628

[76] **Inventor: Paul F. Coakley, 21 Ellis St., Brockton,
Mass. 02401**

Primary Examiner—Stella Reid
Attorney, Agent, or Firm—John P. McGonagle

[**] **Term: 14 Years**

[57] **CLAIM**

[21] **Appl. No.: 64,264**

The ornamental design for a cardiopulmonary resuscitation pillow, as shown and described.

[22] **Filed: Nov. 22, 1996**

DESCRIPTION

[51] **LOC (6) Cl. 24-01**

FIG. 1 is a perspective view of a cardiopulmonary resuscitation pillow embodying my new design;

[52] **U.S. Cl. D24/164; D24/191**

FIG. 2 is a rear view thereof;

[58] **Field of Search D24/191, 190,**

FIG. 3 is a left elevational view thereof;

D24/164; 5/637, 636, 640; 128/845, DIG. 23;
601/41; 602/18, 13, 17

FIG. 4 is a front view thereof;

FIG. 5 is a right elevational view thereof;

FIG. 6 is a bottom view thereof; and,

FIG. 7 is a top view thereof.

[56] **References Cited**

The broken line showing of a patient on the cardiopulmonary resuscitation pillow is for illustrative purposes only and forms no part of the claimed design.

U.S. PATENT DOCUMENTS

D. 244,315 5/1977 Haustad D24/183
3,804,082 4/1974 Tarjan et al. 601/41
3,870,038 3/1975 Arblaster 601/41

1 Claim, 5 Drawing Sheets

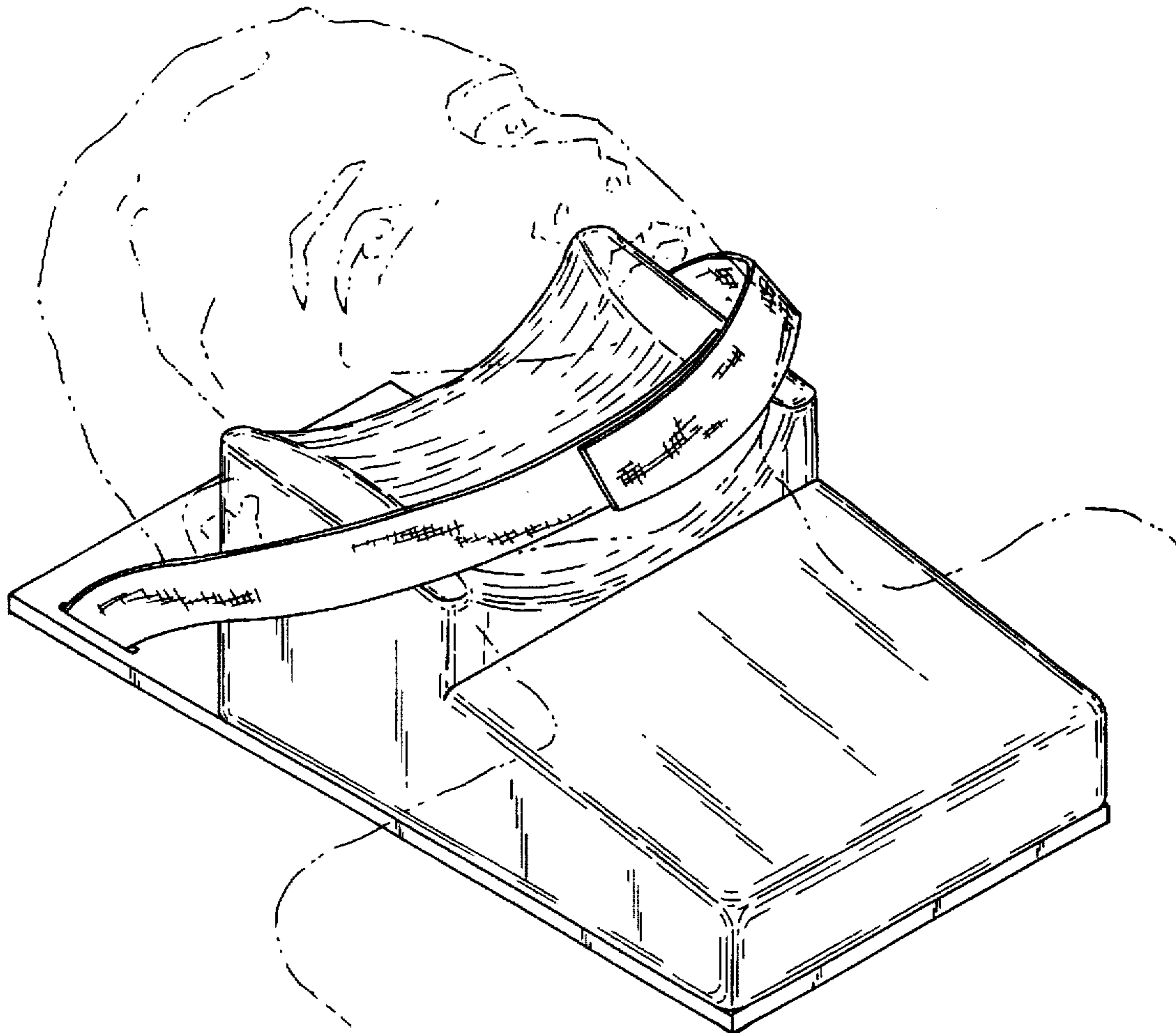
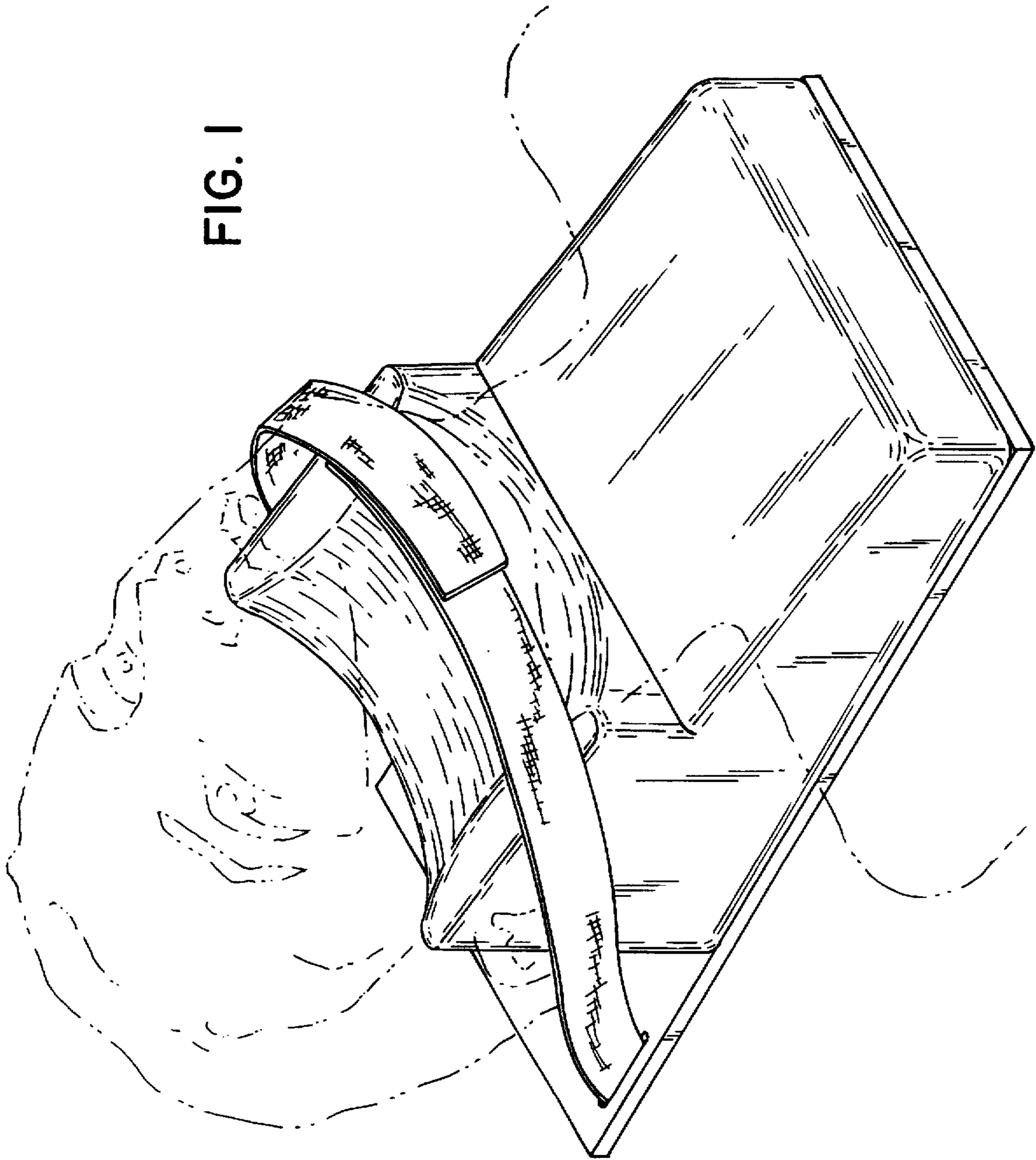

FIG. 1



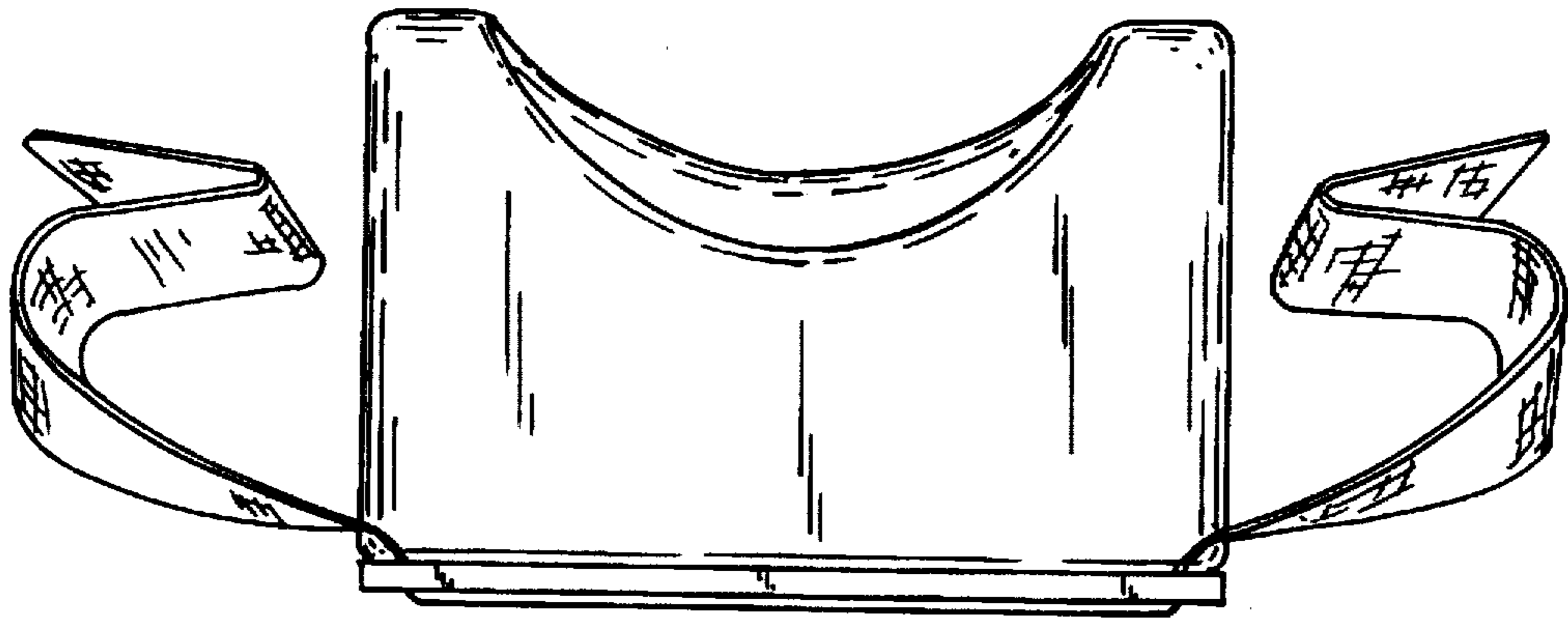

FIG. 2

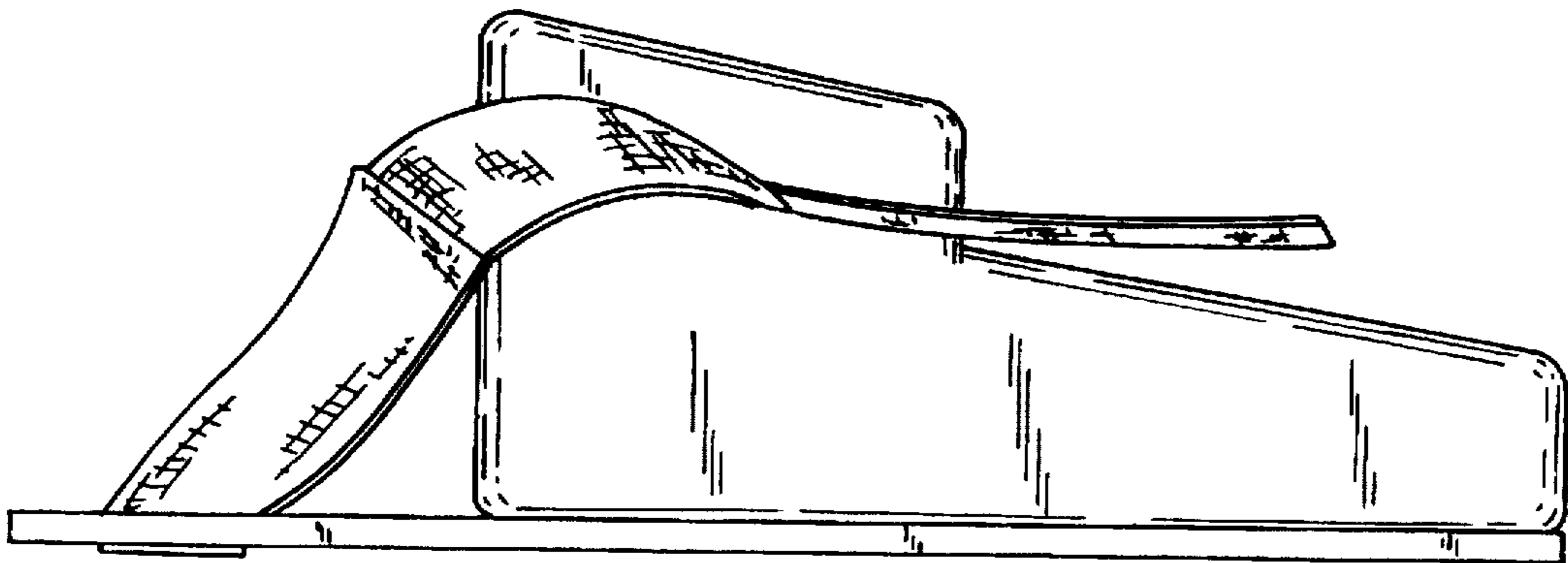

FIG. 3

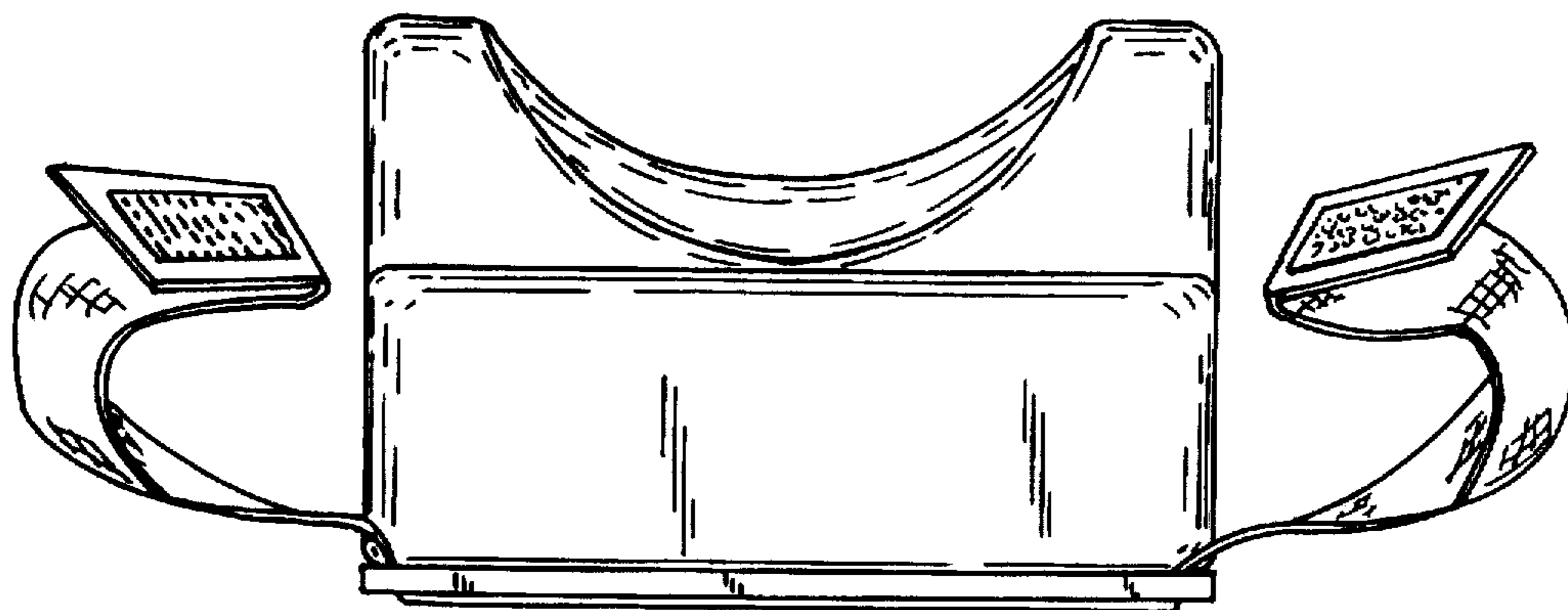

FIG. 4

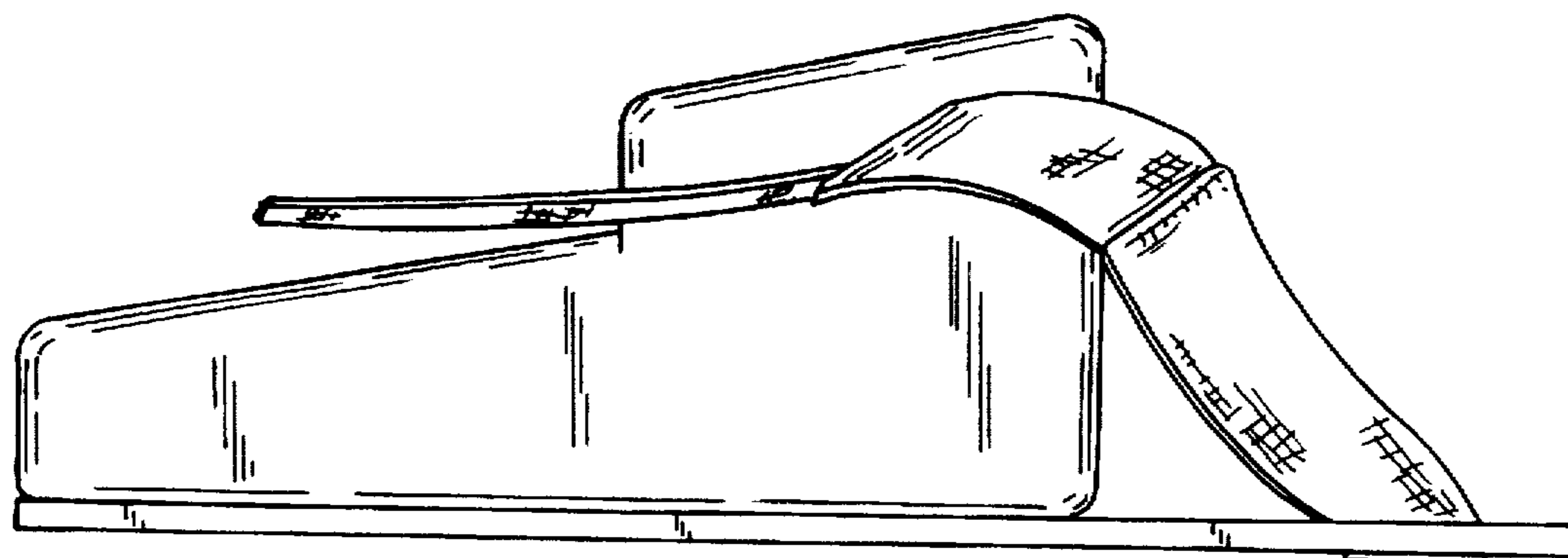

FIG. 5

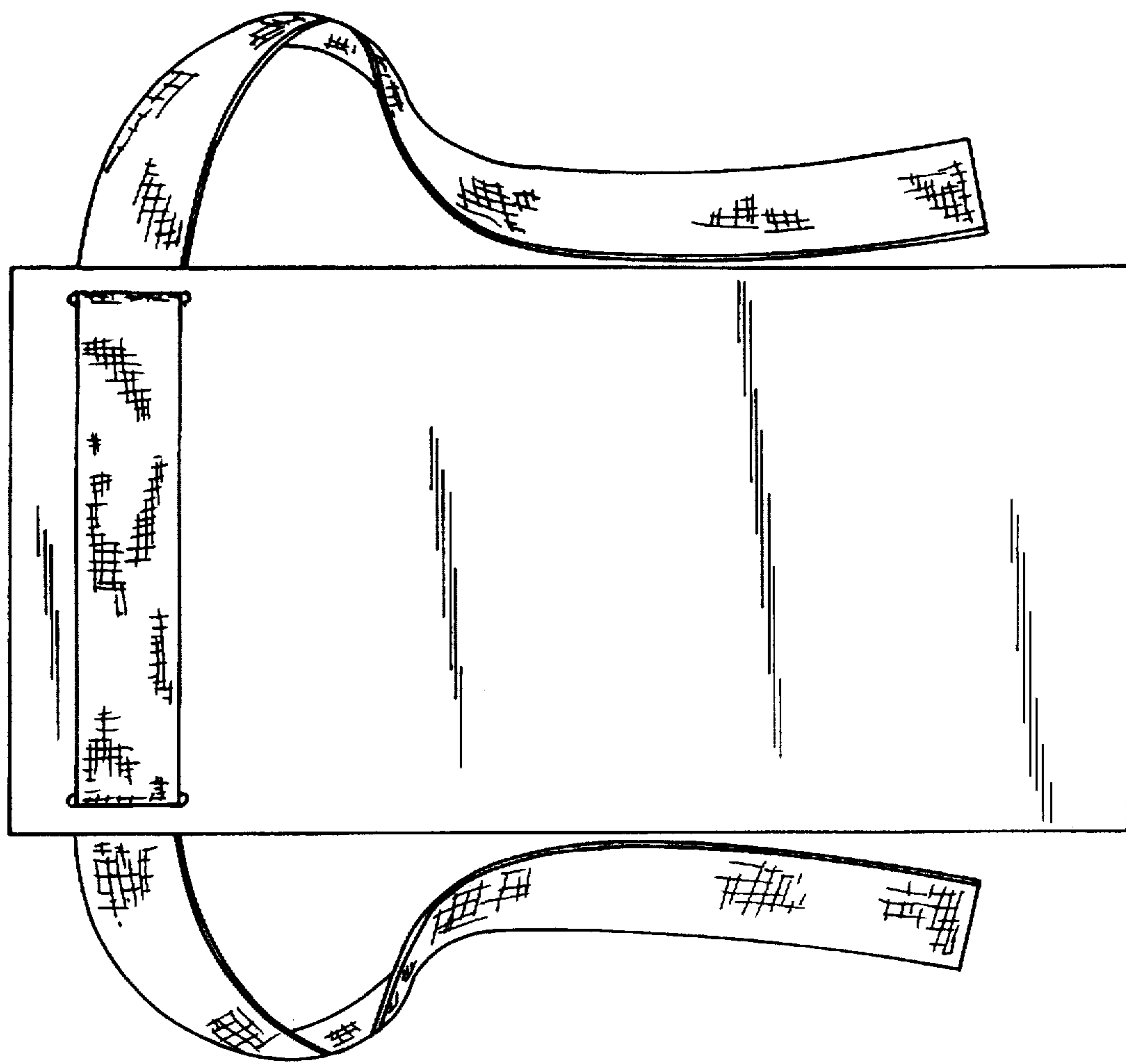

FIG. 6

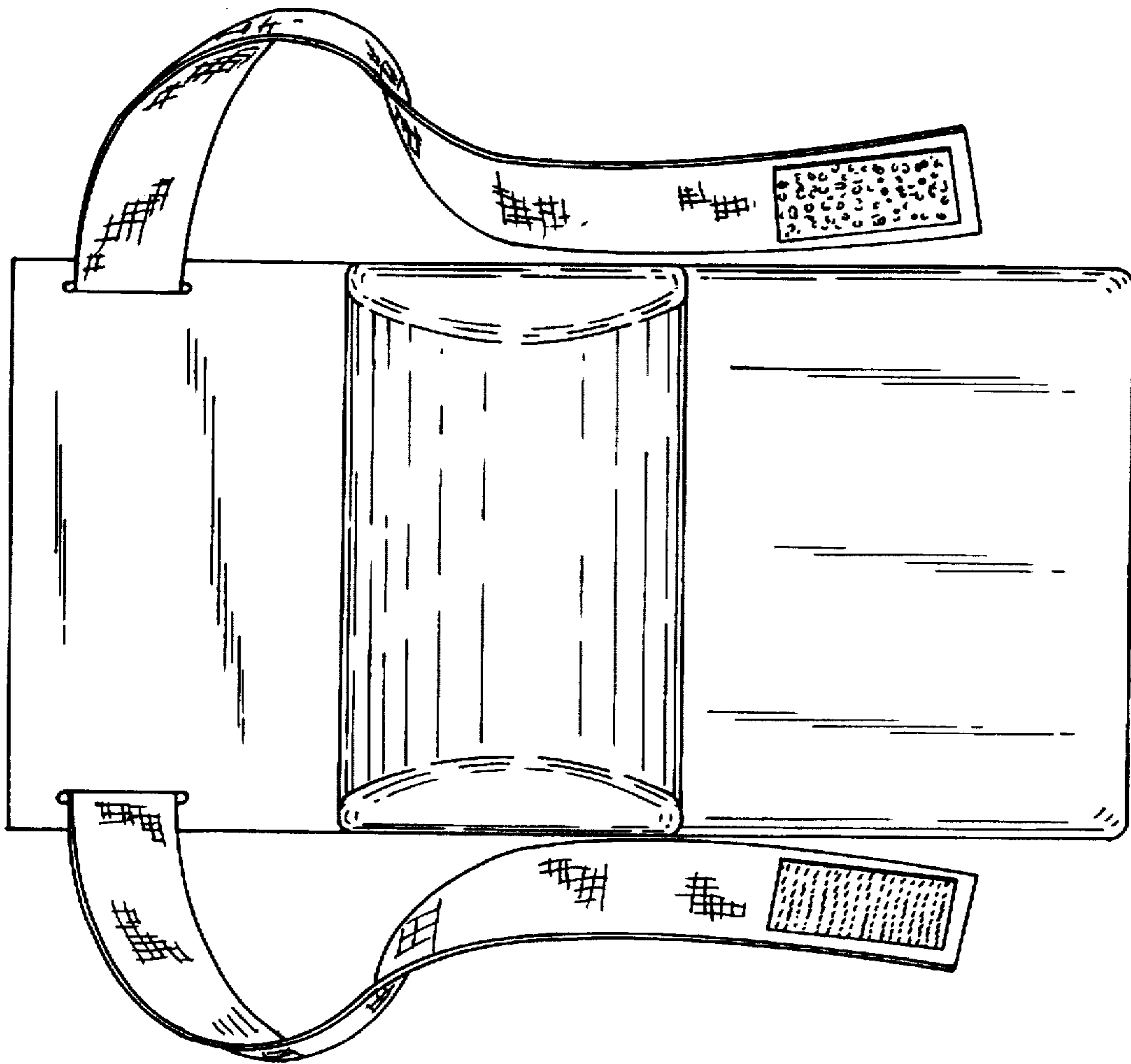

FIG. 7