



US00D391275S

United States Patent [19]
Spiegel

[11] **Patent Number: Des. 391,275**
[45] **Date of Patent: **Feb. 24, 1998**

[54] **MOLD FOR TEMPORARY FOOTBALL KICKING TEE**

[76] **Inventor: H. Jay Spiegel, P.O. Box 444, Mount Vernon, Va. 22121**

[**] **Term: 14 Years**

[21] **Appl. No.: 66,660**

[22] **Filed: Feb. 14, 1997**

[51] **LOC (6) Cl. 15-09**

[52] **U.S. Cl. D15/135**

[58] **Field of Search D15/135, 136; 473/420**

[56] **References Cited**

U.S. PATENT DOCUMENTS

4,657,252 4/1987 Spiegel 473/420

Primary Examiner—Antoine Duval Davis
Attorney, Agent, or Firm—H. Jay Spiegel

[57] **CLAIM**

The ornamental design for a mold for temporary football kicking tee, as shown and described.

DESCRIPTION

FIG. 1 shows a top, right rear perspective view of my claimed design;

FIG. 2 shows a side view of my claimed design of which the other side is identical;

FIG. 3 shows a front view of my claimed design;

FIG. 4 shows a rear view of my claimed design;

FIG. 5 shows a top view of my claimed design;

FIG. 6 show a bottom view of my claimed design;

FIG. 7 shows a side view of my claimed design showing accessory mold rings attached that increase the height of a finished temporary football kicking tee;

FIG. 8 shows a rear view of my claimed design showing accessory mold rings attached that increase the height of a finished temporary football kicking tee;

FIG. 9 shows a cross-sectional view along the line 9—9 of FIG. 7;

FIG. 10 shows a cross-sectional view along the line 10—10 of FIG. 8;

FIG. 11 shows a top, right rear perspective view of my claimed design;

FIG. 12 shows a side view of my claimed design of which the other side is identical;

FIG. 13 shows a front view of my claimed design of which the other side is identical;

FIG. 14 shows a top, right rear perspective view of my claimed design;

FIG. 15 shows a side view of my claimed design of which the other side is identical; and,

FIG. 16 shows a front view of my claimed design of which the other side is identical.

1 Claim, 5 Drawing Sheets

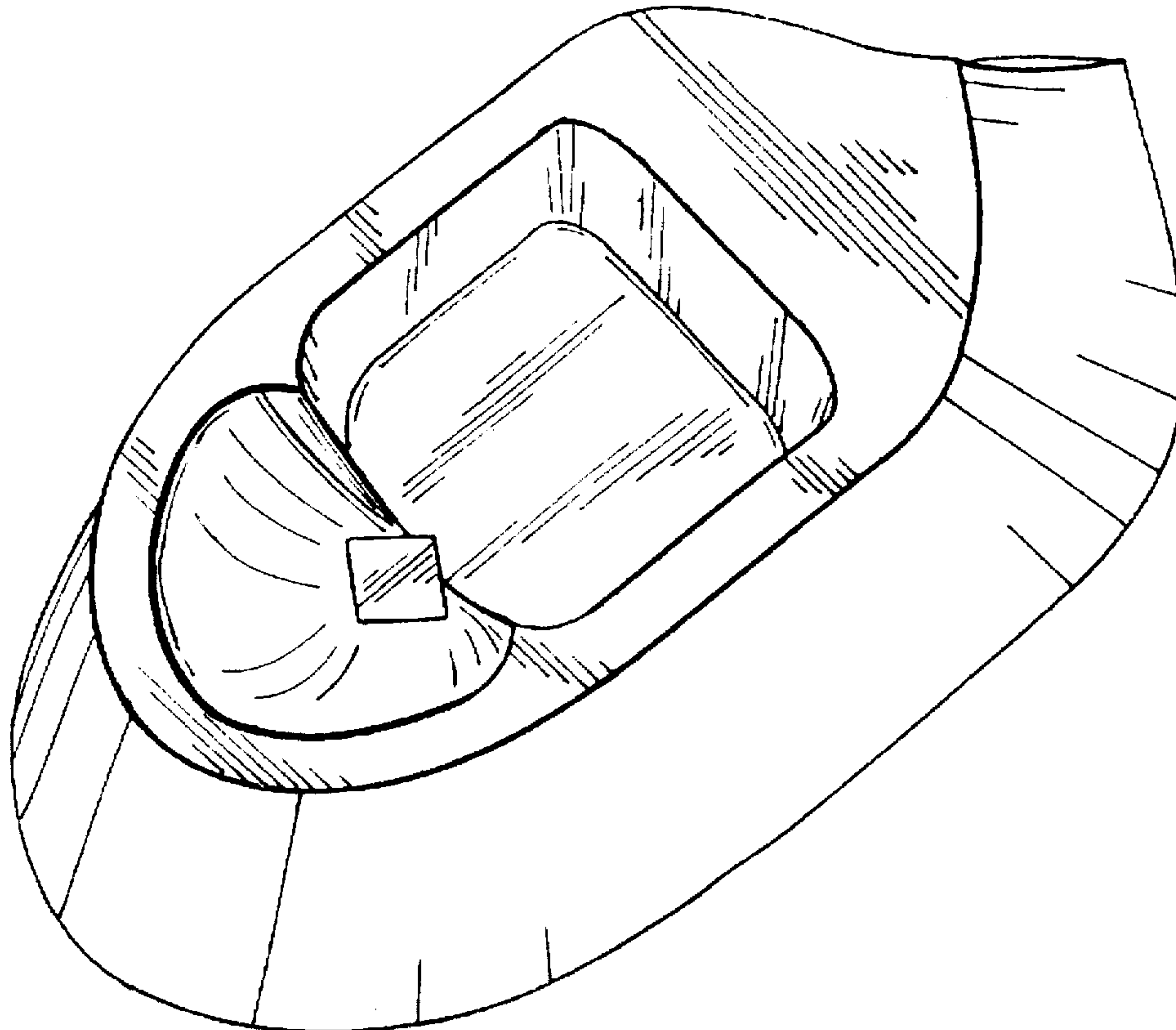

FIG. 1

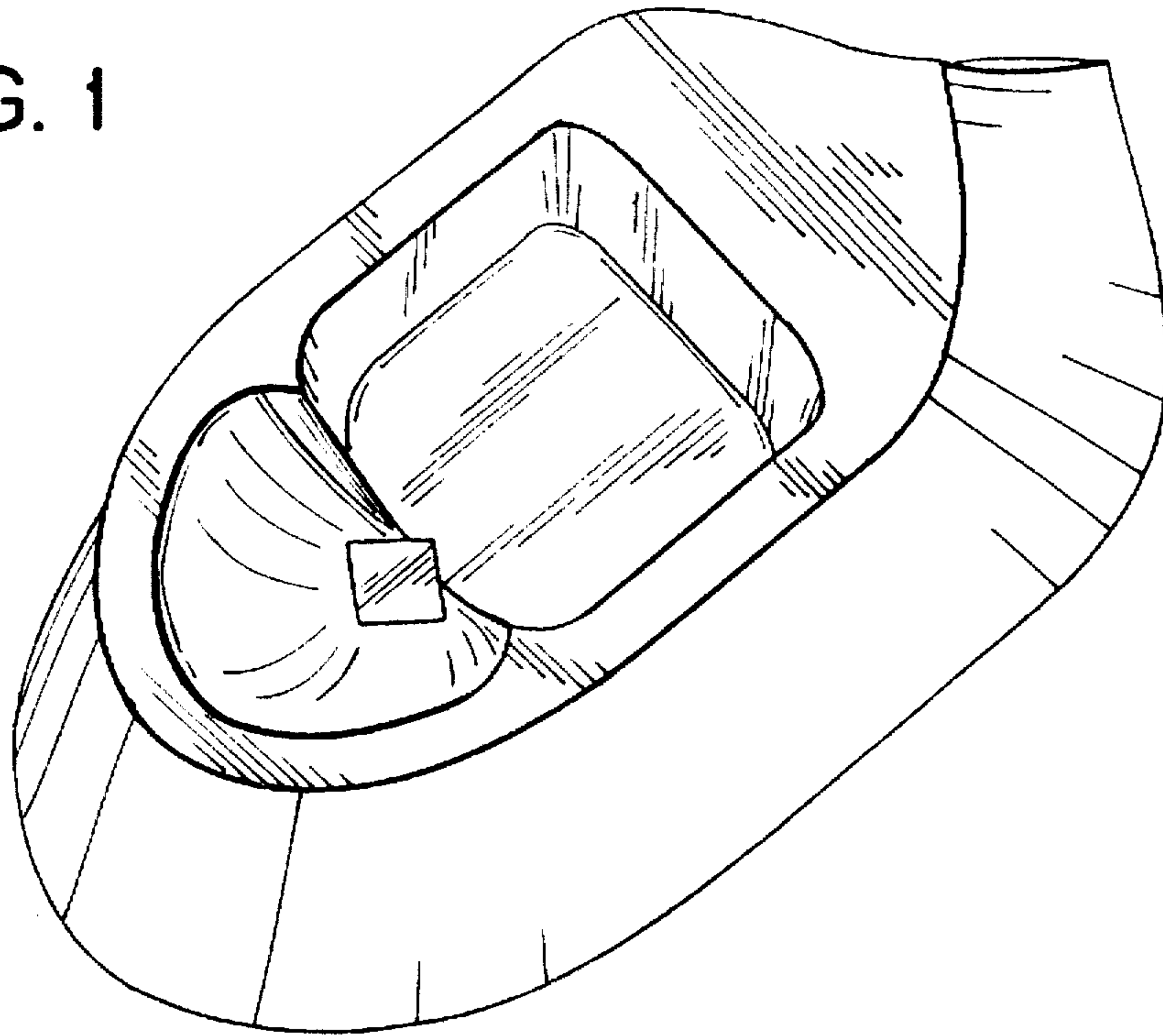

FIG. 2

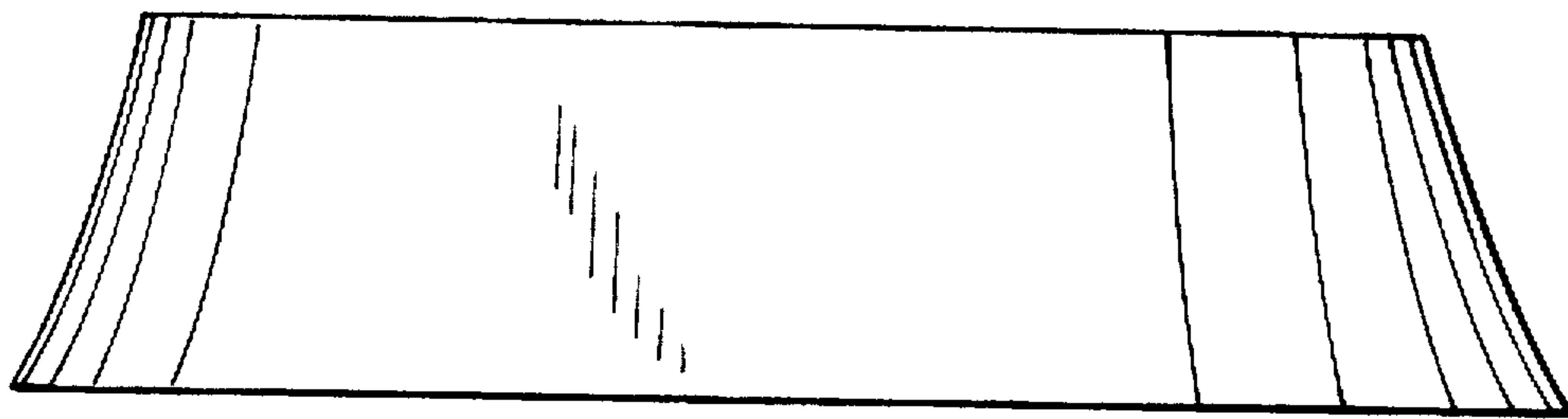

FIG. 3

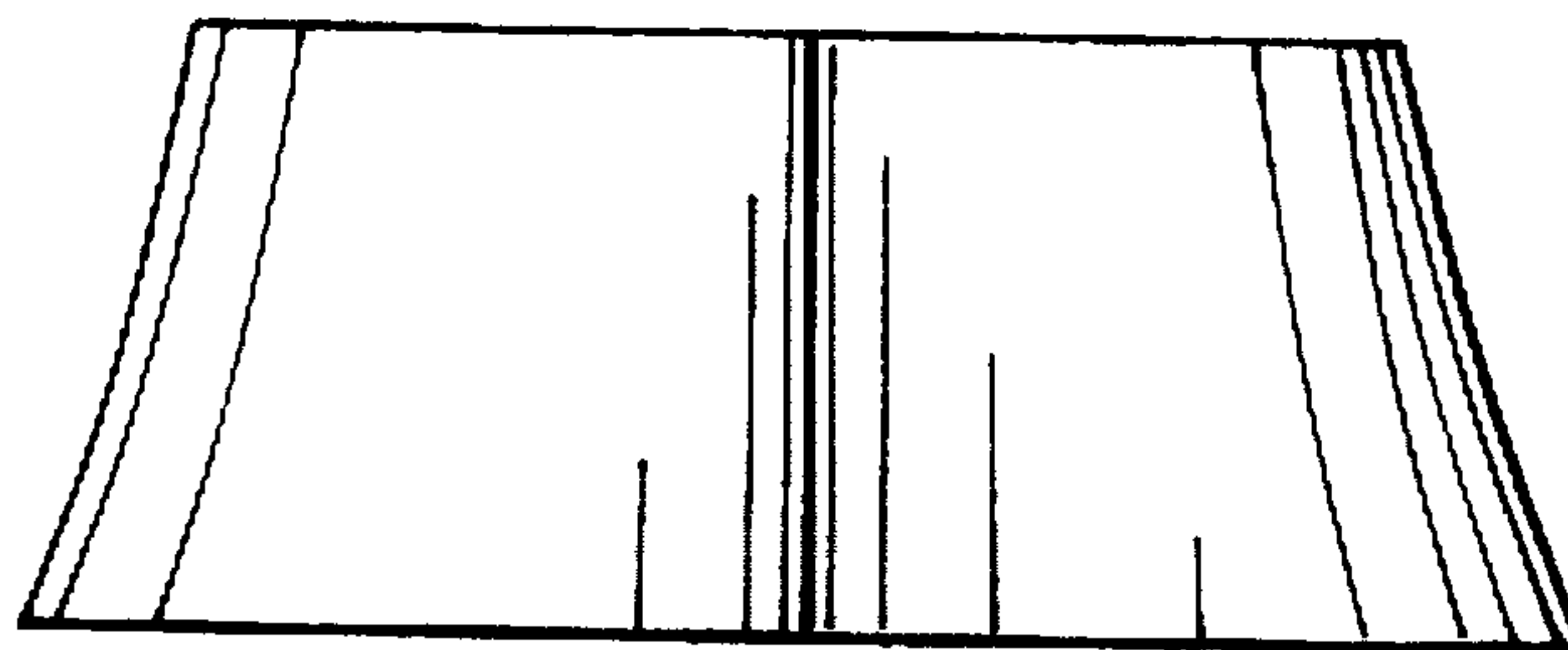

FIG. 4

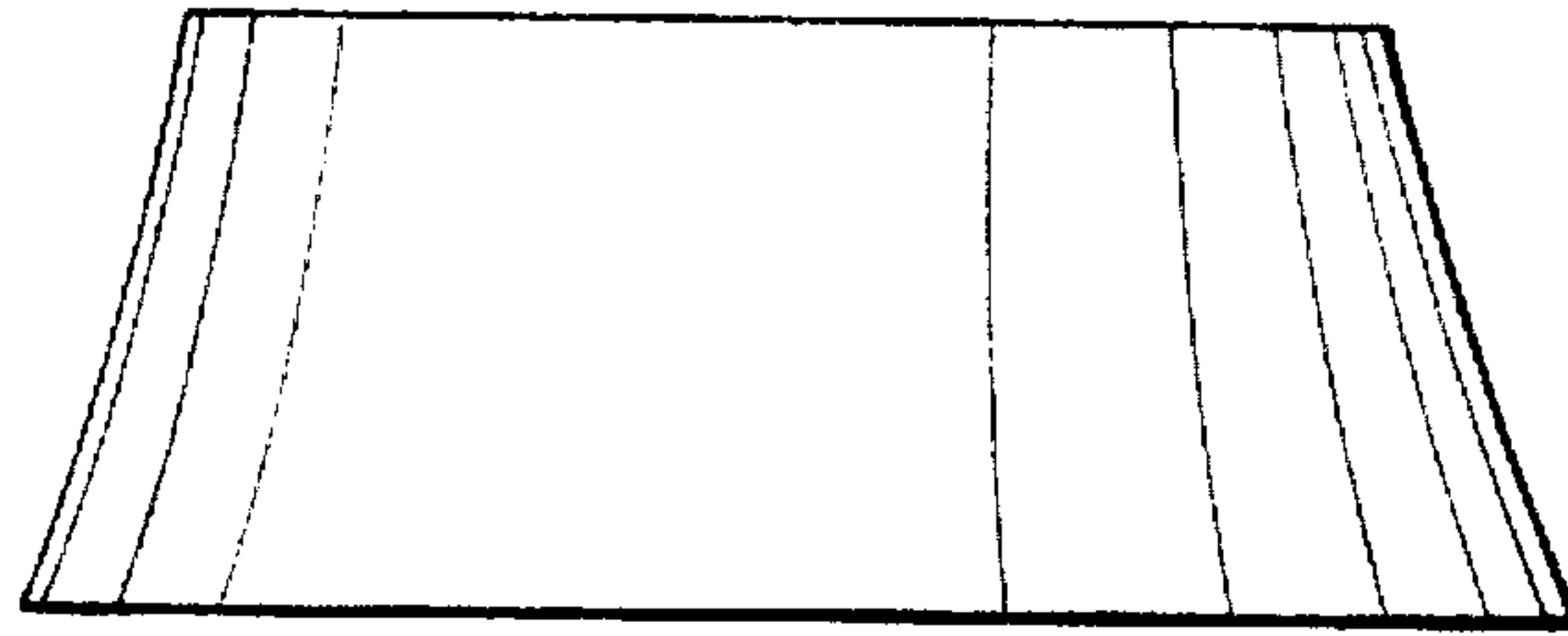

FIG. 5

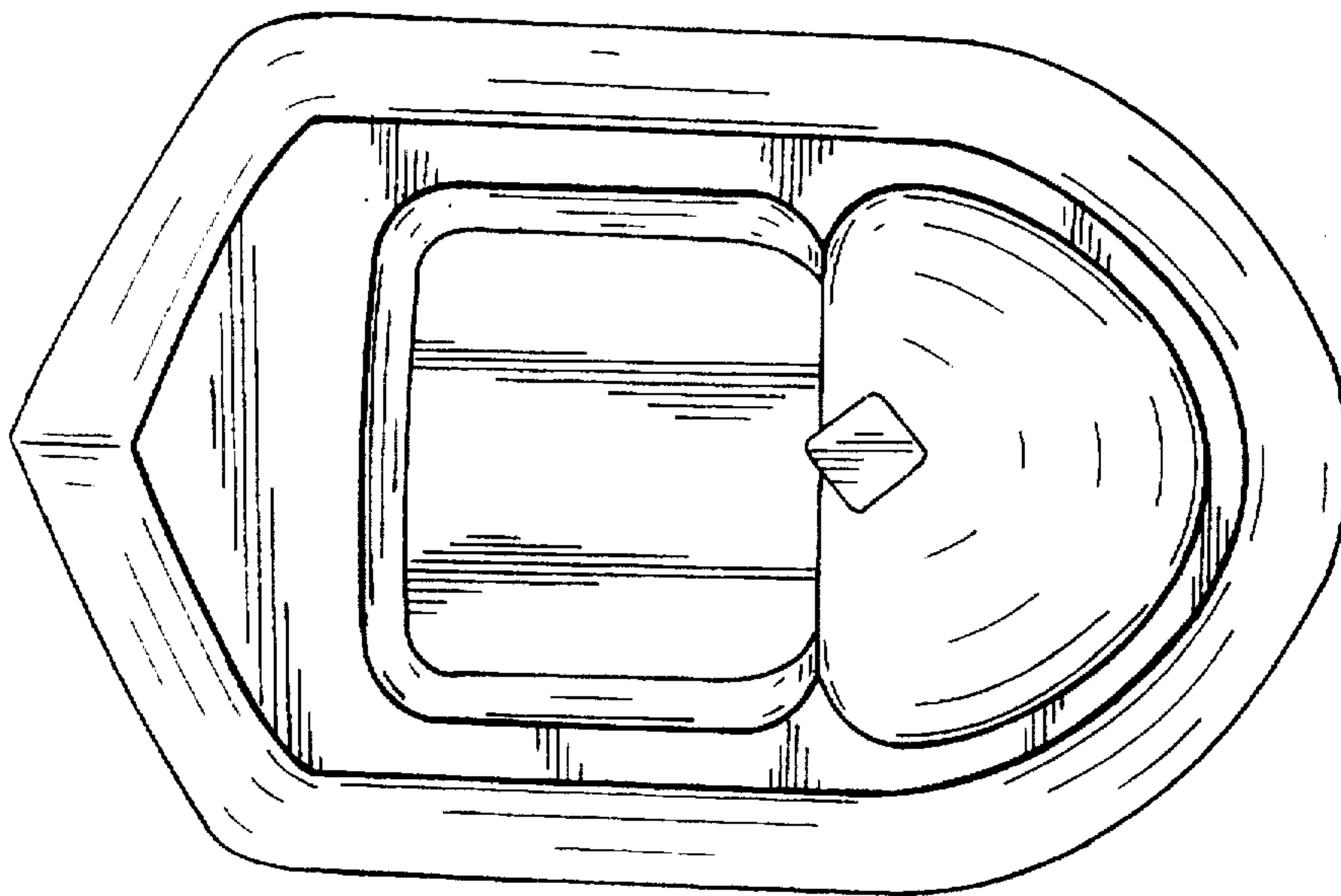

FIG. 6

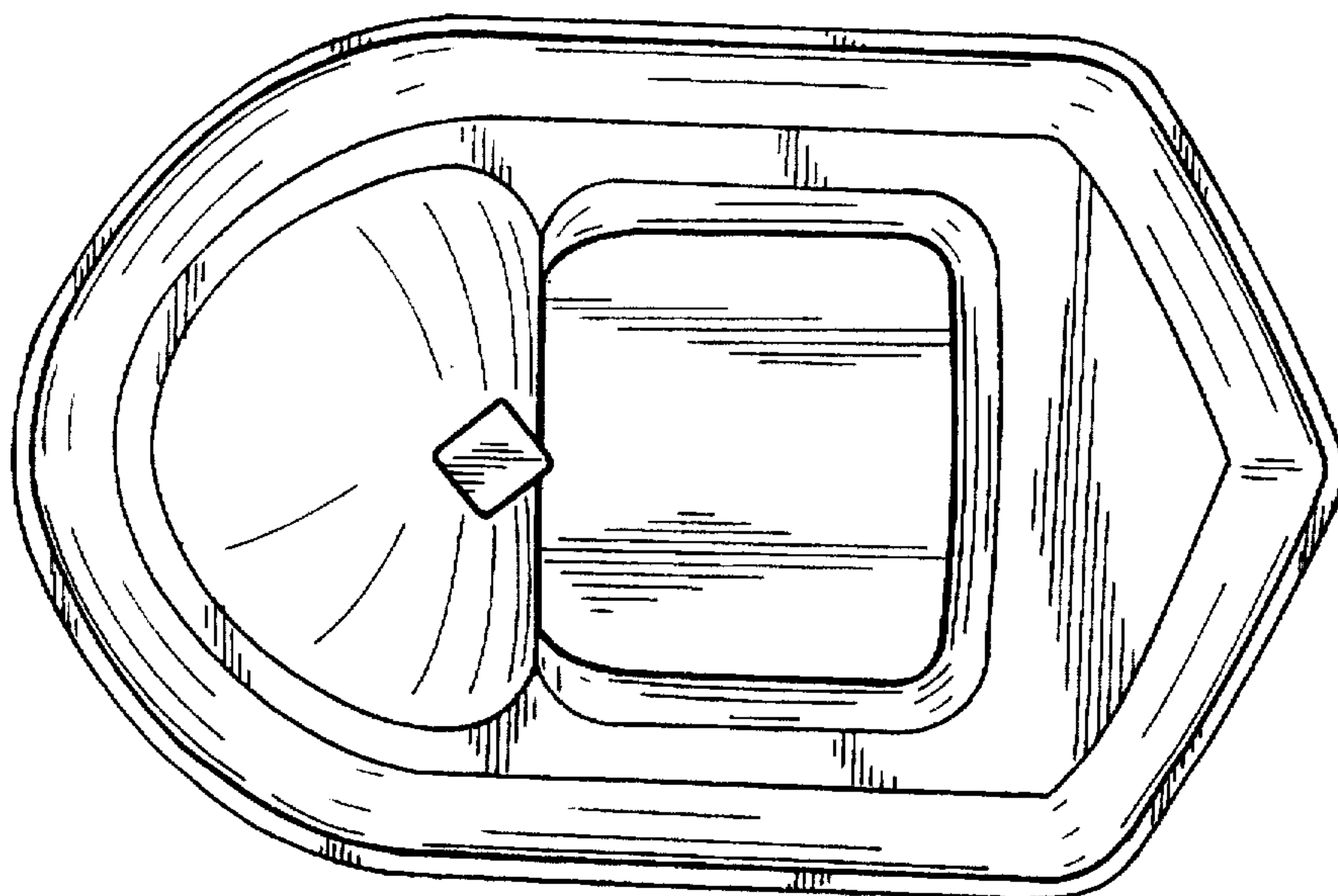

FIG. 7

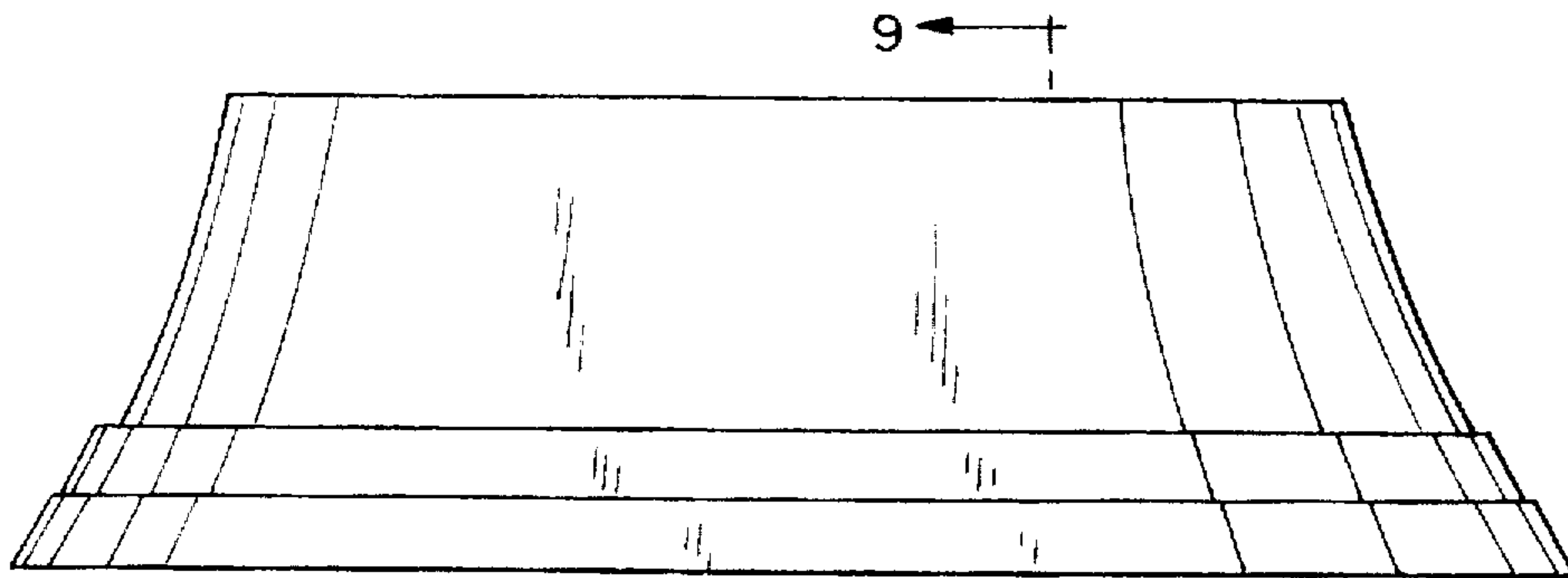

FIG. 8

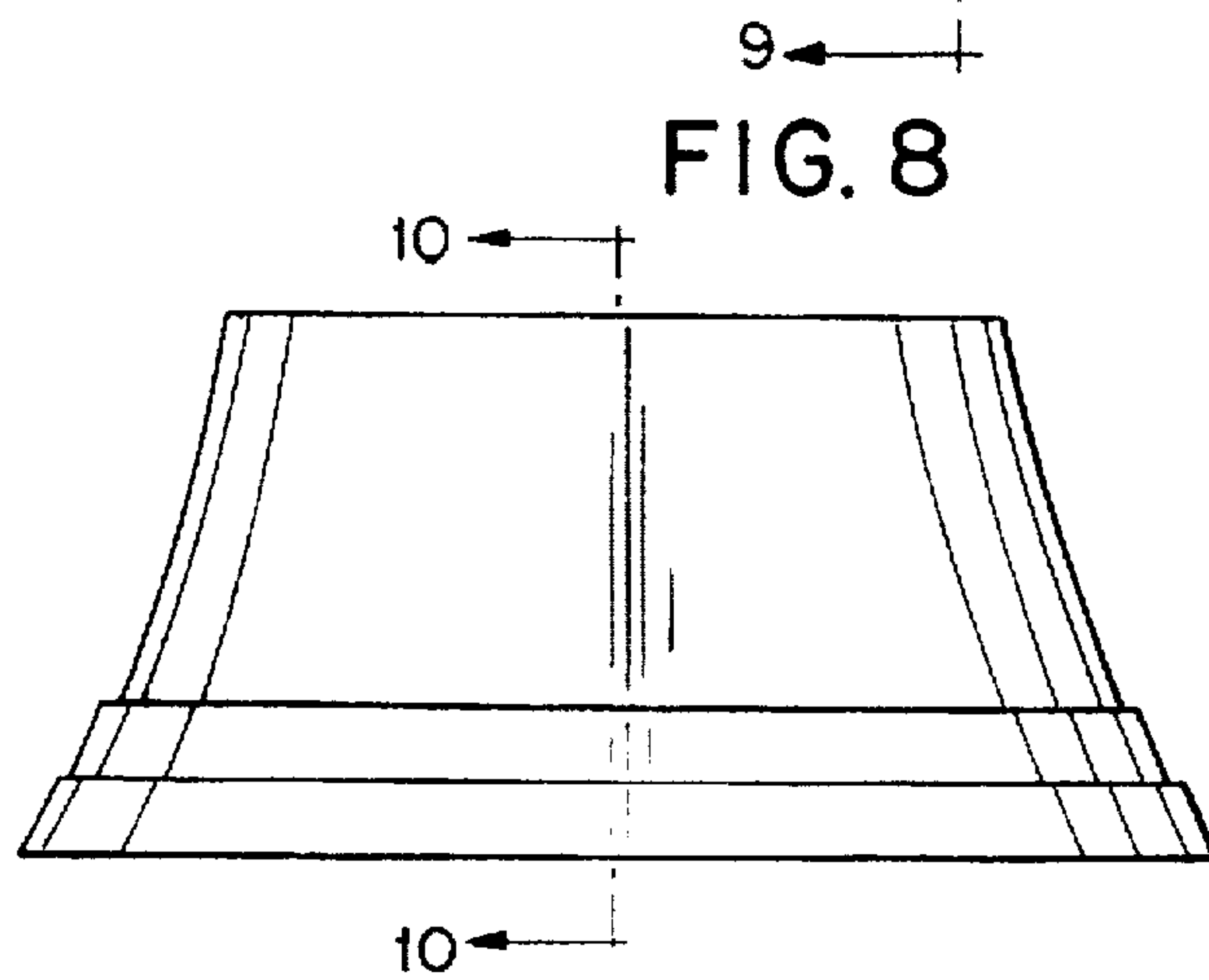

FIG. 9

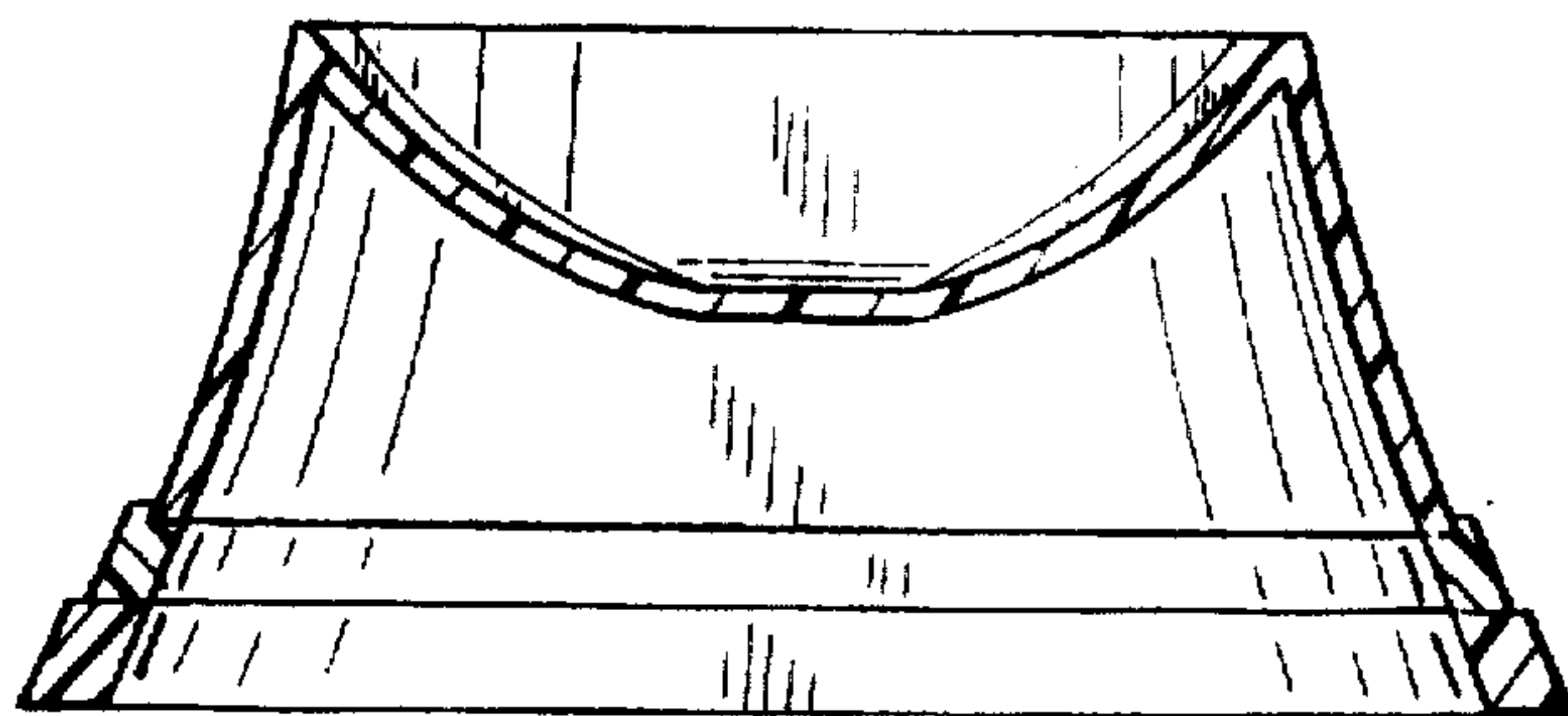

FIG. 10

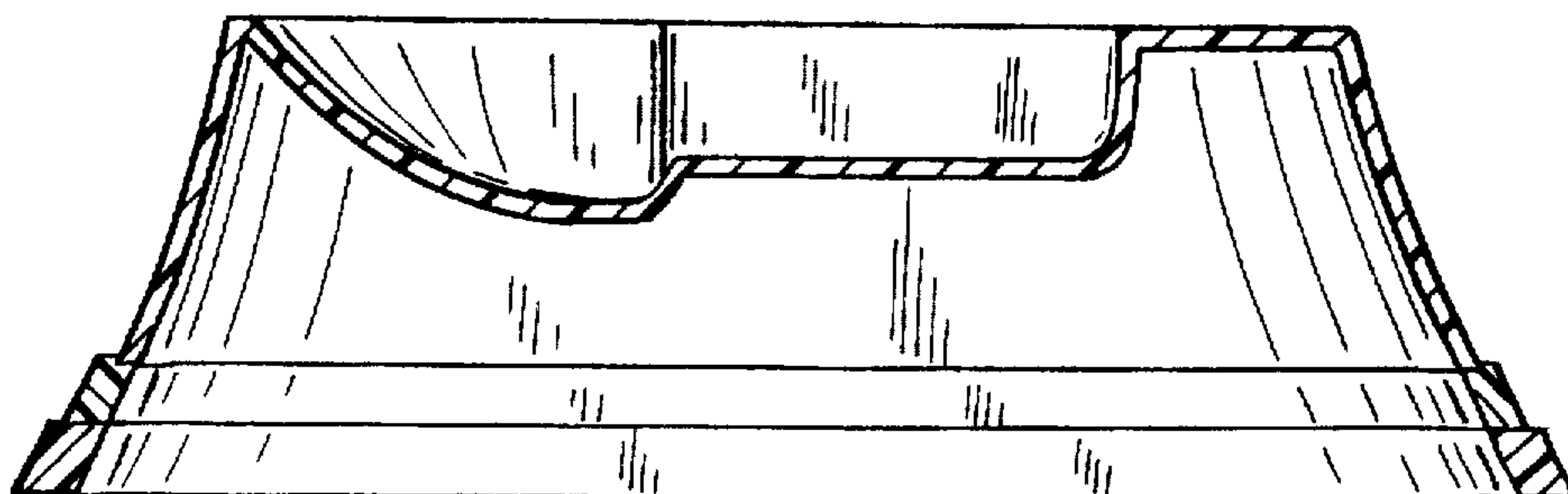

FIG. 11

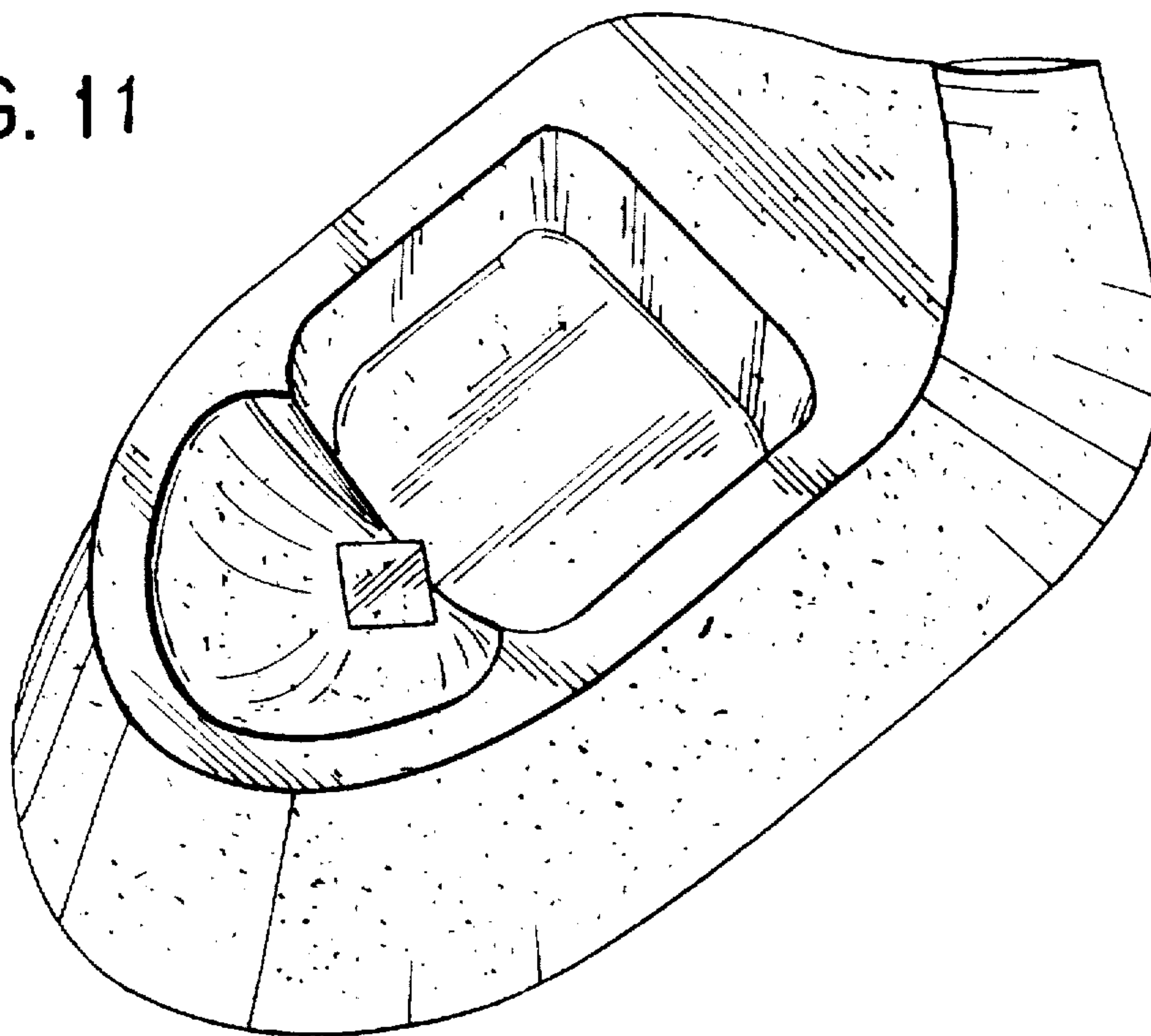

FIG.12

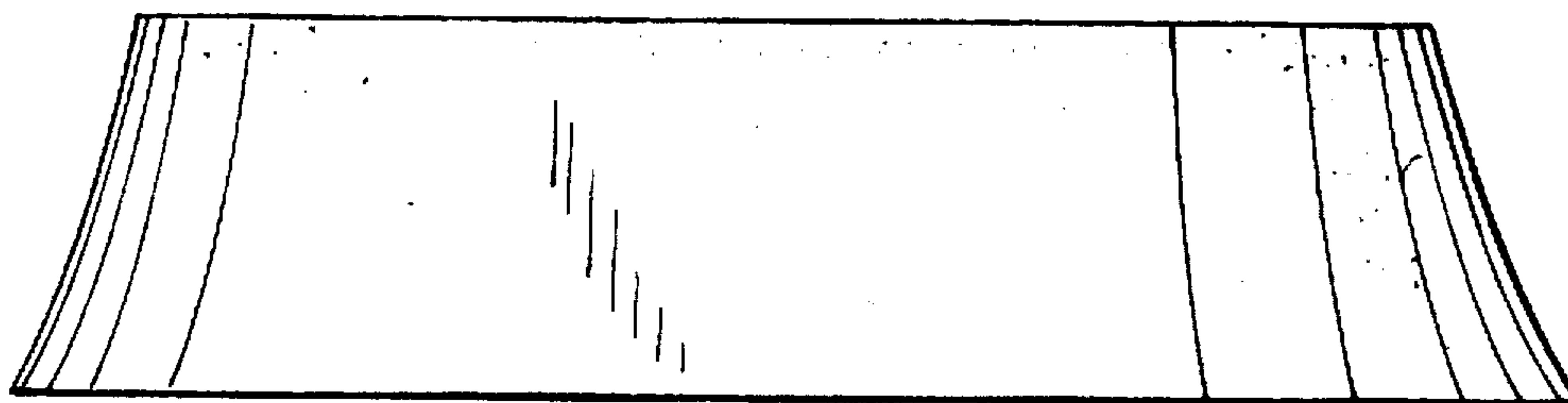

FIG.13



FIG. 14

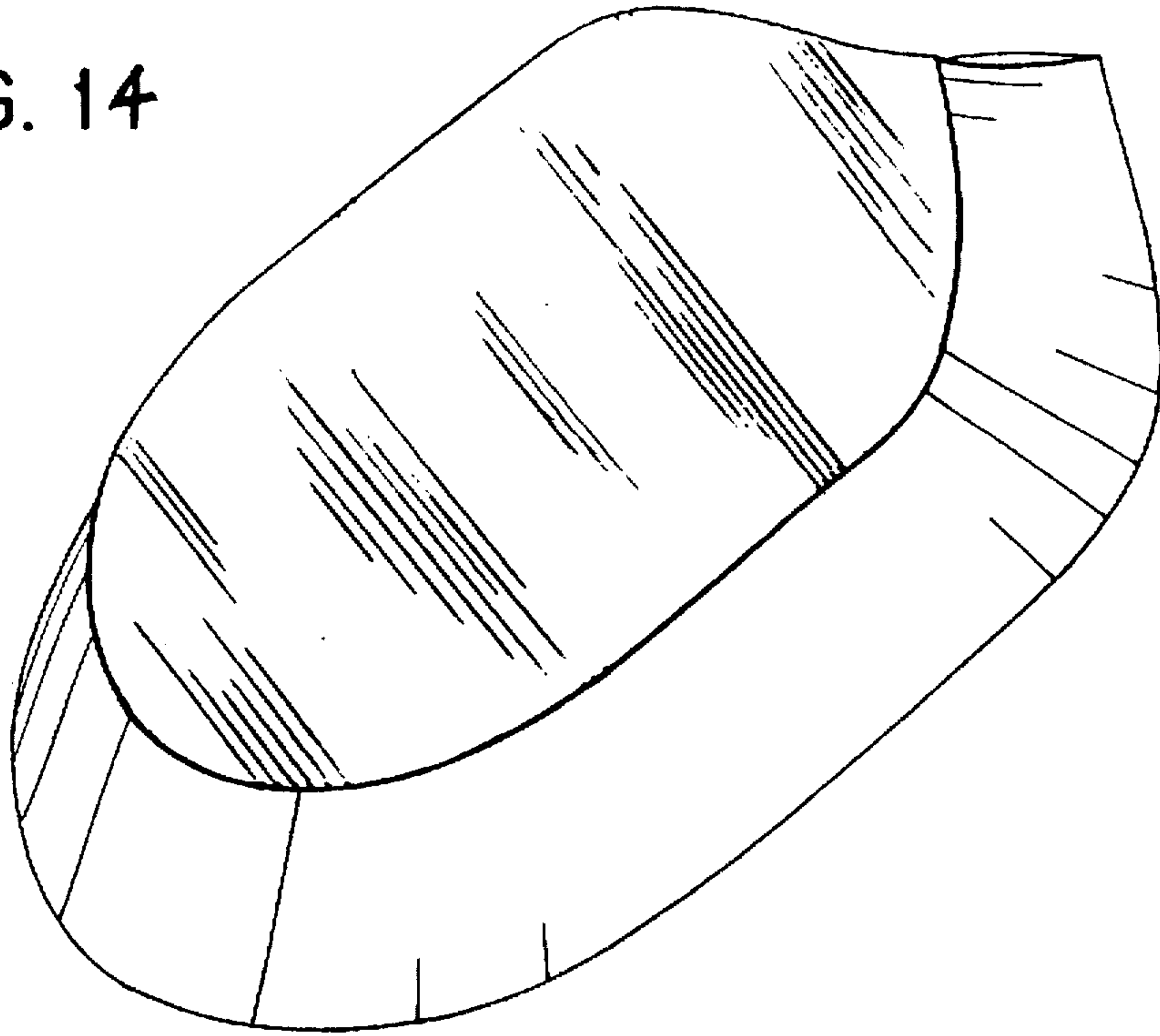

FIG. 15

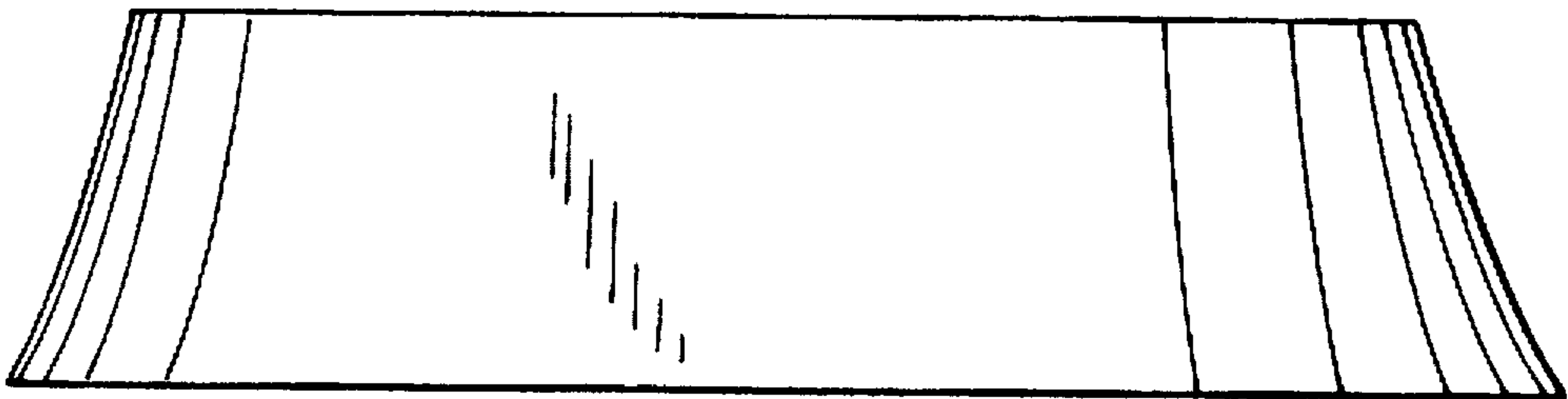

FIG. 16

