



US00D391239S

**United States Patent** [19]  
**Carlson**

[11] **Patent Number: Des. 391,239**  
[45] **Date of Patent: \*\*Feb. 24, 1998**

[54] **STAND-ALONE DRIVE FOR DISK-SHAPED DATA STORAGE MEDIA**

D. 359,852 7/1995 Wicks ..... D14/109  
D. 362,255 9/1995 Sasaki et al. .... D14/107  
5,402,308 3/1995 Koyanagi et al. .... 361/685

[75] Inventor: **Bruce W. Carlson**, Minneapolis, Minn.

*Primary Examiner*—Freda Nunn  
*Attorney, Agent, or Firm*—Eric D. Levinson

[73] Assignee: **Imation Corp.**, Oakdale, Minn.

[\*\*] Term: **14 Years**

[57] **CLAIM**

[21] Appl. No.: **64,670**

The ornamental design for a stand-alone drive for disk-shaped data storage media, as shown and described.

[22] Filed: **Jan. 8, 1997**

**DESCRIPTION**

[51] **LOC (6) Cl.** ..... **14-02**

[52] **U.S. Cl.** ..... **D14/109**

[58] **Field of Search** ..... D14/100, 107,  
D14/108, 109; D13/162, 184, 199; D6/432,  
436, 445, 448; 312/208.1; 360/97.01, 97.04,  
98.01, 99.01, 99.12; 361/694, 683, 696,  
685

FIG. 1 is a front isometric view of a stand-alone drive for disk-shaped data storage media according to the present invention;

FIG. 2 is a top view of the drive shown in FIG. 1;

FIG. 3 is a bottom view of the drive shown in FIG. 1;

FIG. 4 is a side view of the drive shown in FIG. 1; the opposite side view is identical;

FIG. 5 is a front view of the drive shown in FIG. 1; and,

FIG. 6 is a rear view of the drive shown in FIG. 1.

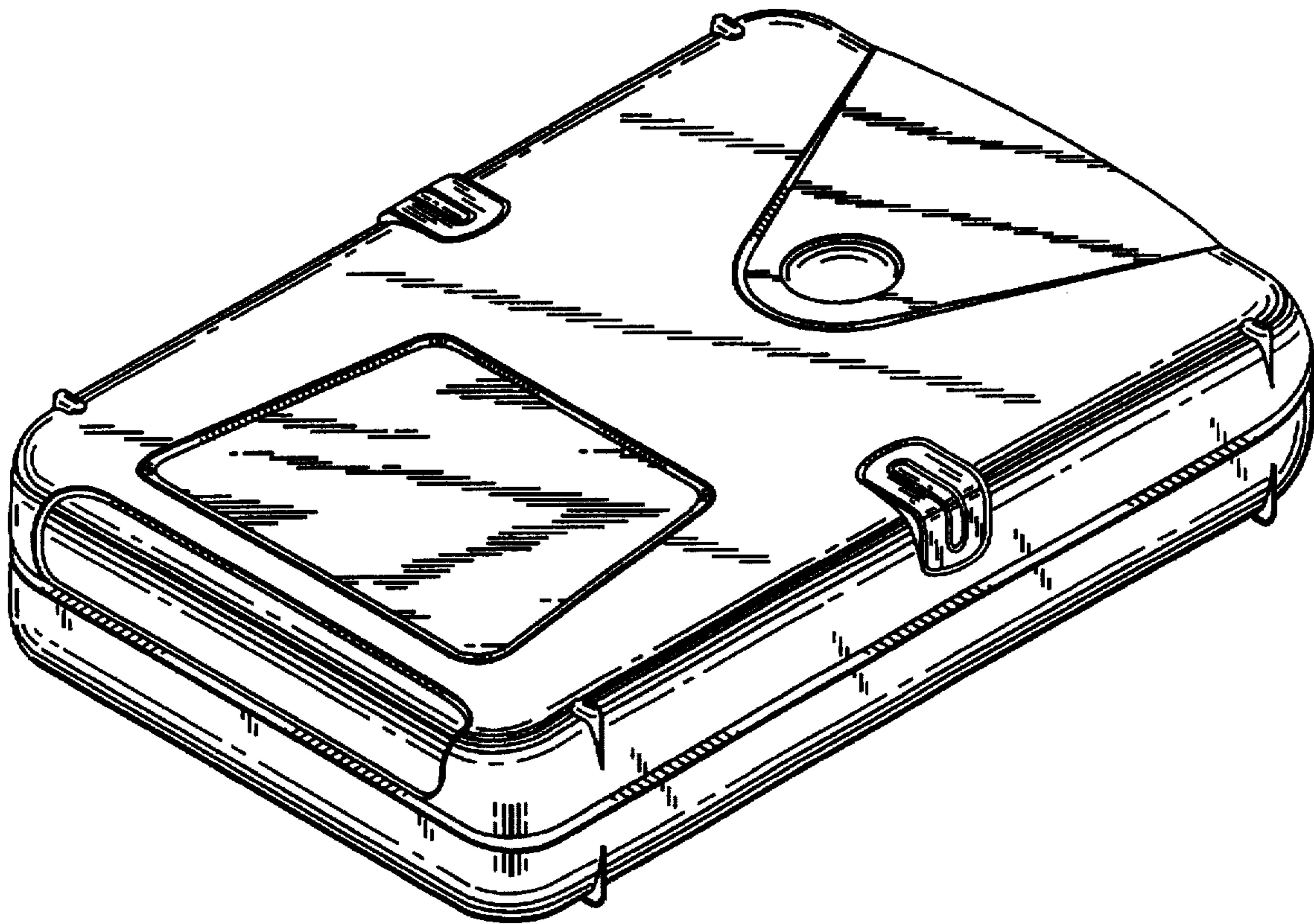
The circular elements in FIG. 5 and the portions of the disk cartridge in FIG. 6 are shown in broken lines for illustrative purposes only and form no part of the claimed design.

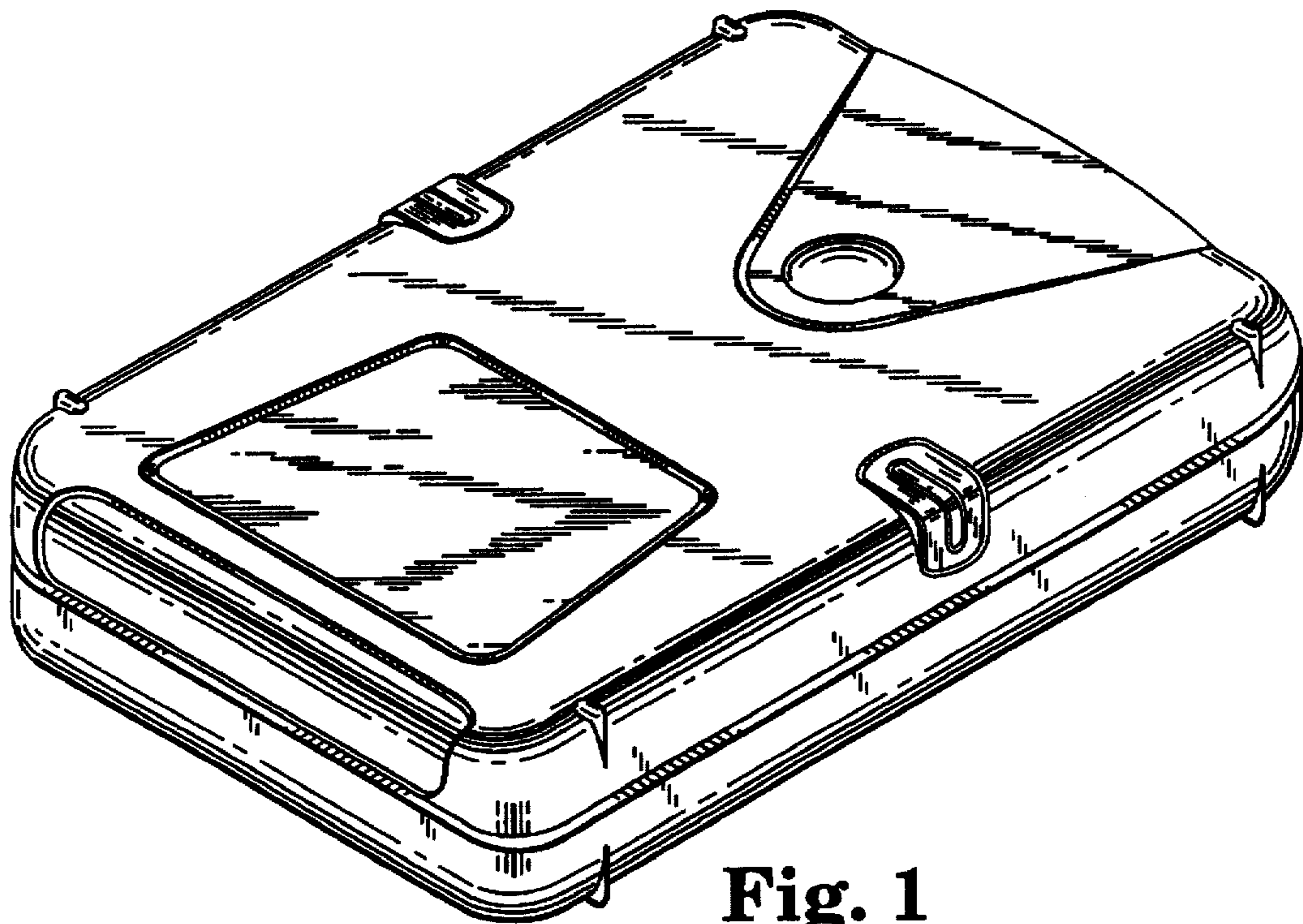
[56] **References Cited**

**U.S. PATENT DOCUMENTS**

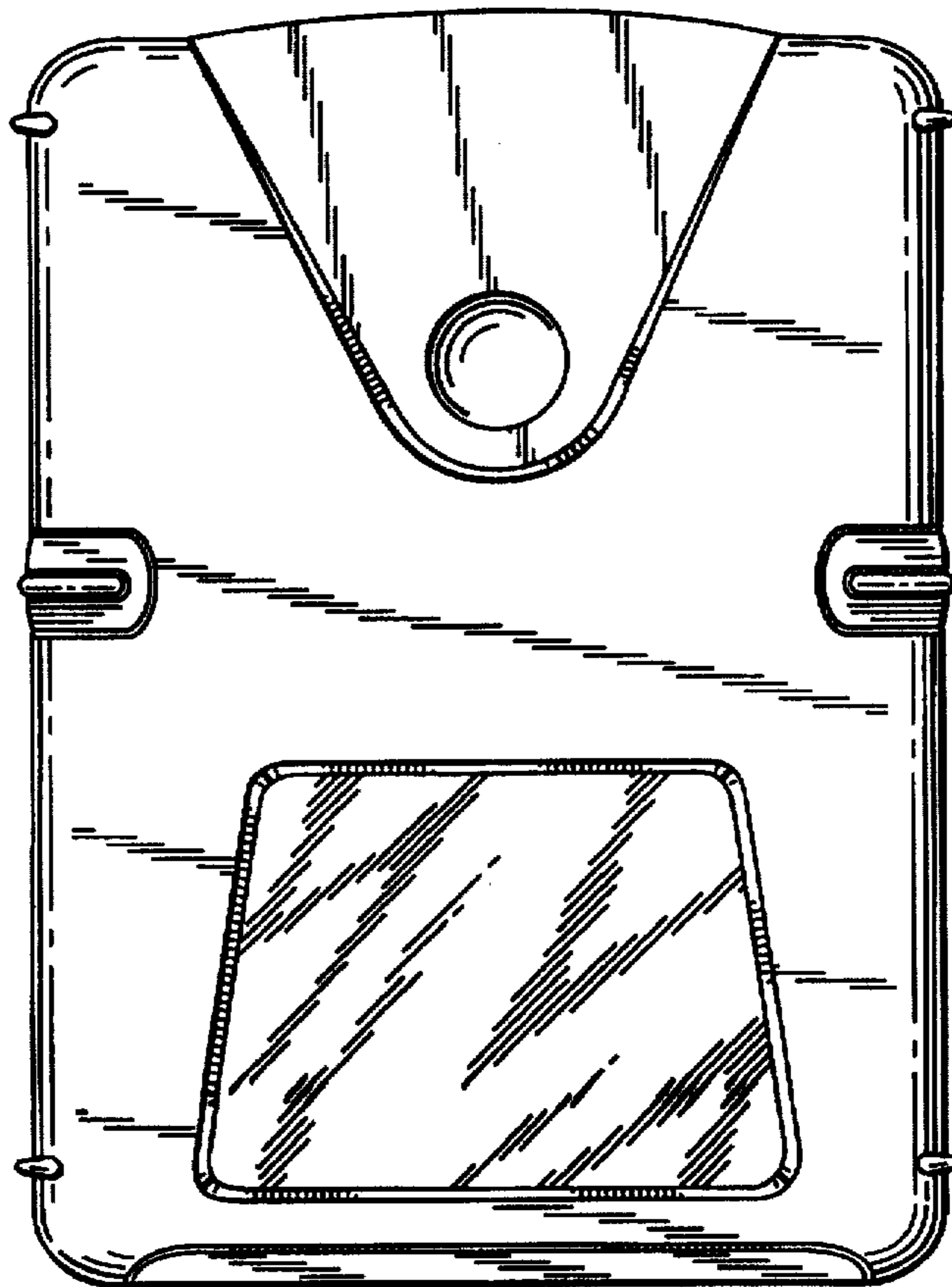
D. 327,878 7/1992 Fukutake et al. .... D14/107  
D. 348,070 6/1994 Vallillee ..... D14/107 X  
D. 358,138 5/1995 Koyanagi et al. .... D14/109

**1 Claim, 2 Drawing Sheets**

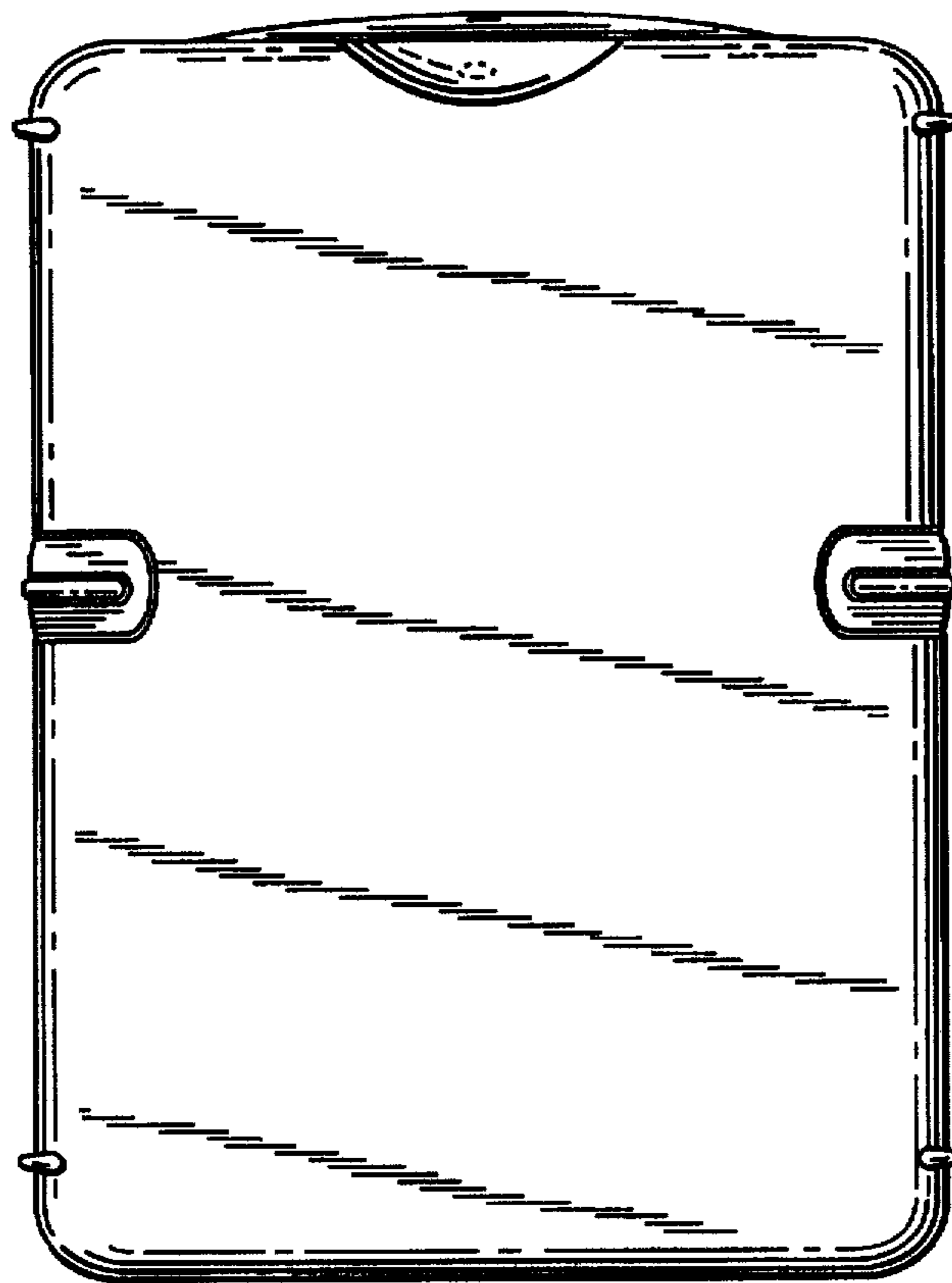




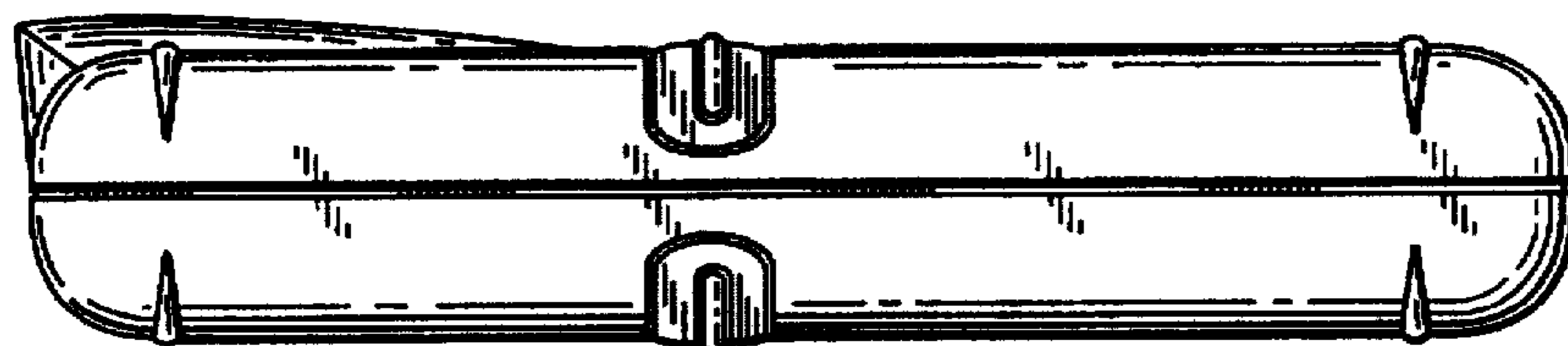
**Fig. 1**



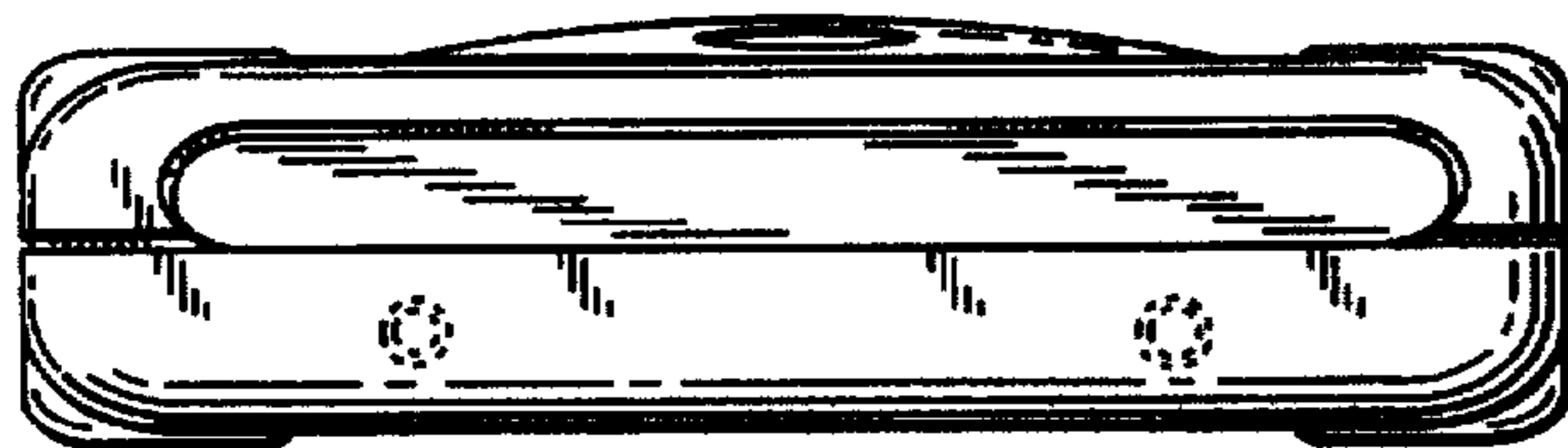
**Fig. 2**



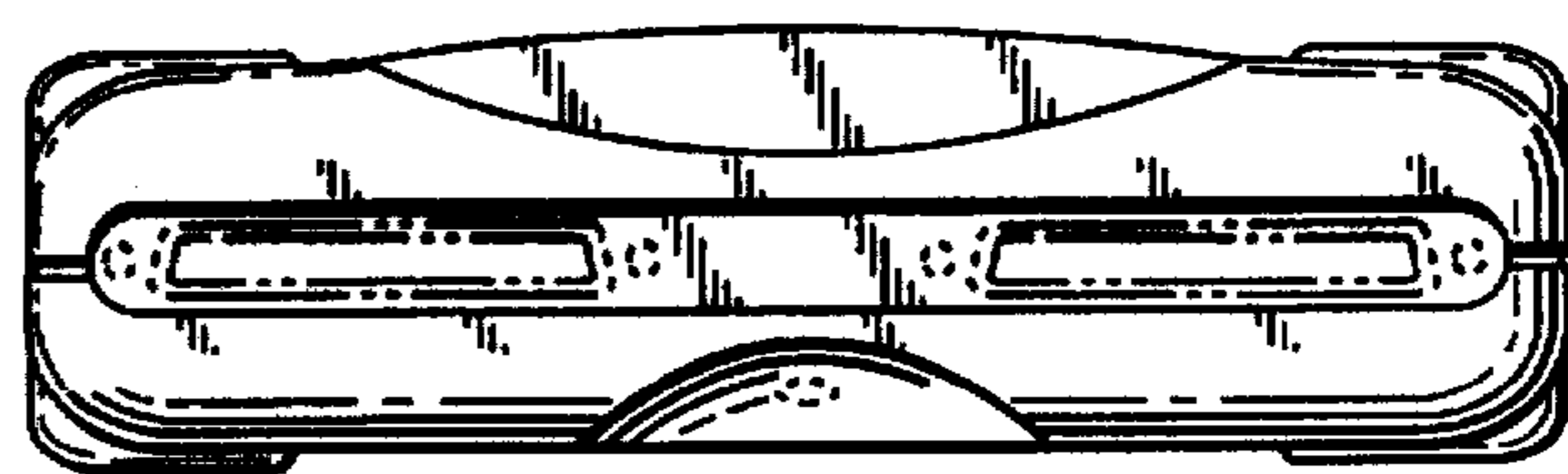
**Fig. 3**



**Fig. 4**



**Fig. 5**



**Fig. 6**