



US00D391195S

United States Patent [19]

[11] Patent Number: **Des. 391,195**

Weder et al.

[45] Date of Patent: *****Feb. 24, 1998**

[54] FLOWER POT COVER

[75] Inventors: **Donald E. Weder; Joseph G. Straeter,**
both of Highland, Ill.

[73] Assignee: **Southpac Trust International, Inc.**

[*] Notice: The portion of the term of this patent
subsequent to Jun. 11, 2010, has been
disclaimed.

[**] Term: **14 Years**

[21] Appl. No.: **46,110**

[22] Filed: **Nov. 7, 1995**

Related U.S. Application Data

[60] Division of Ser. No. 2,916, Dec. 23, 1992, Pat. No. Des.
364,585, which is a continuation-in-part of Ser. No. 807,674,
Dec. 16, 1991, Pat. No. Des. 366,009, which is a continu-
ation-in-part of Ser. No. 710,272, Jun. 4, 1991, Pat. No. Des.
365,302, which is a continuation-in-part of Ser. No. 617,454,
Nov. 21, 1990, abandoned, Ser. No. 411,249, Sep. 22, 1989,
Pat. No. Des. 358,113, Ser. No. 411,247, Sep. 22, 1989,
abandoned, and Ser. No. 411,245, Sep. 22, 1989, abandoned.

[51] LOC (6) Cl. **11-02**

[52] U.S. Cl. **D11/164**

[58] Field of Search D11/143, 149,
D11/152-156, 164, 89, 90; 47/66, 72; 206/423;
215/100.5; 229/1.5 R, 1.5 B, 4.5, 108, 108.1,
109, 110, 87.01, 922, 930, 186, 189; 428/27,
35.1, 24, 542.6; 338/122; D9/346, 428-431;
D27/102, 133; D26/128-136; D19/96; D7/540,
584, 586, 587, 354

[56] References Cited

U.S. PATENT DOCUMENTS

D. 5,120	7/1871	Snow .	
D. 5,806	4/1872	Palmer .	
D. 50,435	3/1917	Stimpson .	
D. 114,182	4/1939	Heisey .	
D. 139,009	10/1944	Denenberg	D48/16
D. 174,733	5/1955	Bordman	D48/16
D. 292,182	10/1987	Weder et al.	D11/164
D. 292,562	11/1987	Weder et al.	D11/164

D. 293,224	12/1987	Weder et al.	D11/164
D. 293,775	1/1988	Weder et al.	D11/164
D. 317,583	6/1991	Weder et al.	D11/164
D. 318,030	7/1991	Weder et al.	D11/164
D. 327,234	6/1992	Vaughn	D11/143
D. 361,296	8/1995	Weder et al.	D11/164
D. 361,960	9/1995	Weder et al.	D11/164
D. 362,828	10/1995	Weder et al.	D11/164
D. 364,115	11/1995	Weder et al.	D11/164
D. 364,581	11/1995	Weder et al.	D11/164
D. 364,585	11/1995	Weder et al.	D11/164
D. 365,042	12/1995	Weder et al.	D11/164
D. 365,302	12/1995	Weder et al.	D11/164
D. 366,009	1/1996	Weder et al.	D11/164
D. 370,644	6/1996	Wedetr et al.	D11/164
2,334,805	11/1943	Barbieri	229/5.5
2,355,559	8/1944	Renner	229/8
5,127,817	7/1992	Weder et al.	425/383
5,184,390	2/1993	Weder et al.	39/525

FOREIGN PATENT DOCUMENTS

103316 3/1938 Australia .

OTHER PUBLICATIONS

Exhibit A —“The Simple Solution For Those Peak volume
Periods”, a brochure (6 pages), published by Highland
Supply Corporation, 1111 Sixth St., Highland, Illinois
62249, ©1989.

Primary Examiner—Jeffrey Asch
Attorney, Agent, or Firm—Dunlap & Coddling, P.C.

[57] CLAIM

The ornamental design for a flower pot cover, as shown and
described.

DESCRIPTION

FIG. 1 is a perspective view of our new flower pot cover
design;

FIG. 2 is a side elevational view thereof;

FIG. 3 is a top plan view thereof;

FIG. 4 is a bottom plan view thereof;

FIG. 5 is a side elevational view of the design of FIG. 1, the
only difference being in the horizontal angle of the skirt;

FIG. 6 is a side elevational view of the design of FIG. 1, the
only difference being in the skirt;

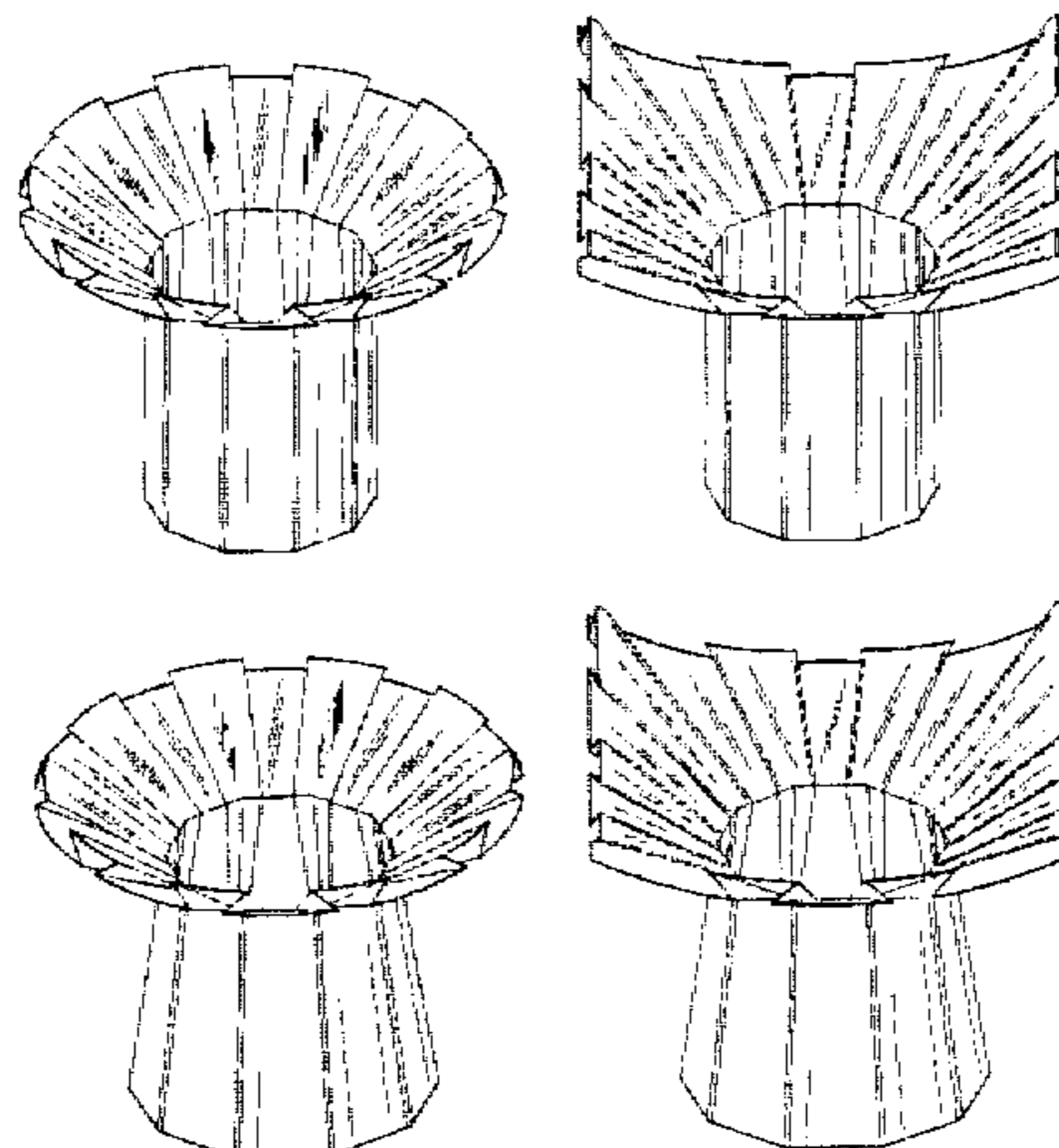

FIG. 7 is a side elevational view of the design of FIG. 1, the only difference being in the downward angle of the skirt;
FIG. 8 is a perspective view of a second embodiment of our new flower pot cover design;
FIG. 9 is a side elevational view thereof;
FIG. 10 is a top plan view thereof;
FIG. 11 is a bottom plan view thereof;
FIG. 12 is a side elevational view of the design of FIG. 8, the only difference being in the horizontal angle of the skirt;
FIG. 13 is a side elevational view of the design of FIG. 8, the only difference in the near vertical angle of the skirt;
FIG. 14 is a side elevational view of the design of FIG. 8, the only difference being in the downward angle of the skirt;
FIG. 15 is a perspective view of a third embodiment of our new flower pot cover design;
FIG. 16 is a side elevational view thereof;
FIG. 17 is a top plan view thereof;
FIG. 18 is a bottom plan view thereof;
FIG. 19 is a side elevational view of the design of FIG. 15, the only difference being in the horizontal angle of the skirt;

FIG. 20 is a side elevational view of the design of FIG. 15, the only difference being in the near vertical angle of the skirt;
FIG. 21 is a side elevational view of the design of FIG. 15, the only difference being in the downward angle of the skirt;
FIG. 22 is a perspective view of a fourth embodiment of our new flower pot cover design;
FIG. 23 is a side elevational view thereof;
FIG. 24 is a top plan view thereof;
FIG. 25 is a bottom plan view thereof;
FIG. 26 is a side elevational view of the design of FIG. 22, the only difference being in the horizontal angle of the skirt;
FIG. 27 is a side elevational view of the design of FIG. 22, the only difference being in the near vertical angle of the skirt; and,
FIG. 28 is a side elevational view of the design of FIG. 22, the only difference being in the downward angle of the skirt.

1 Claim, 7 Drawing Sheets

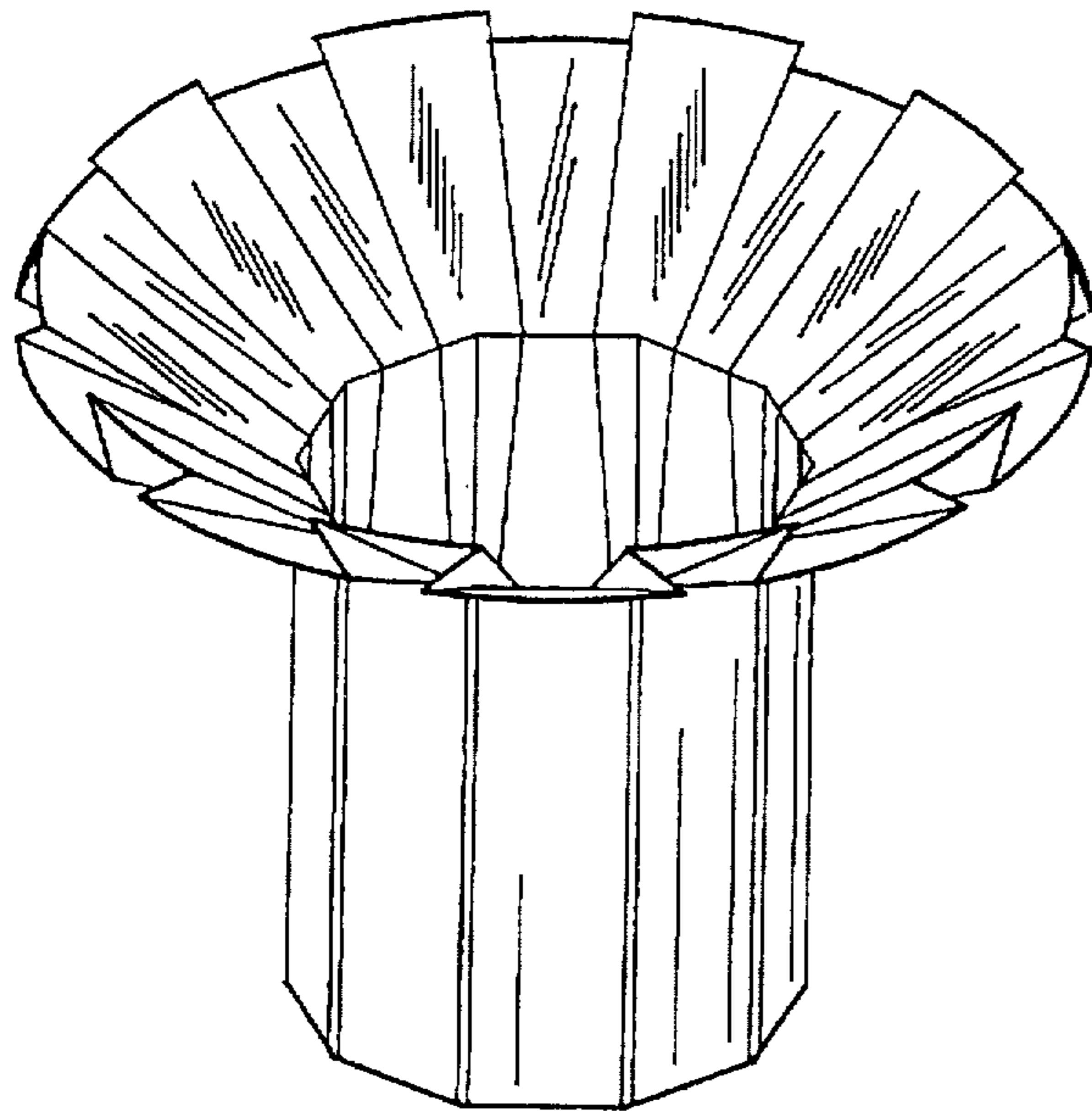

FIG. 1

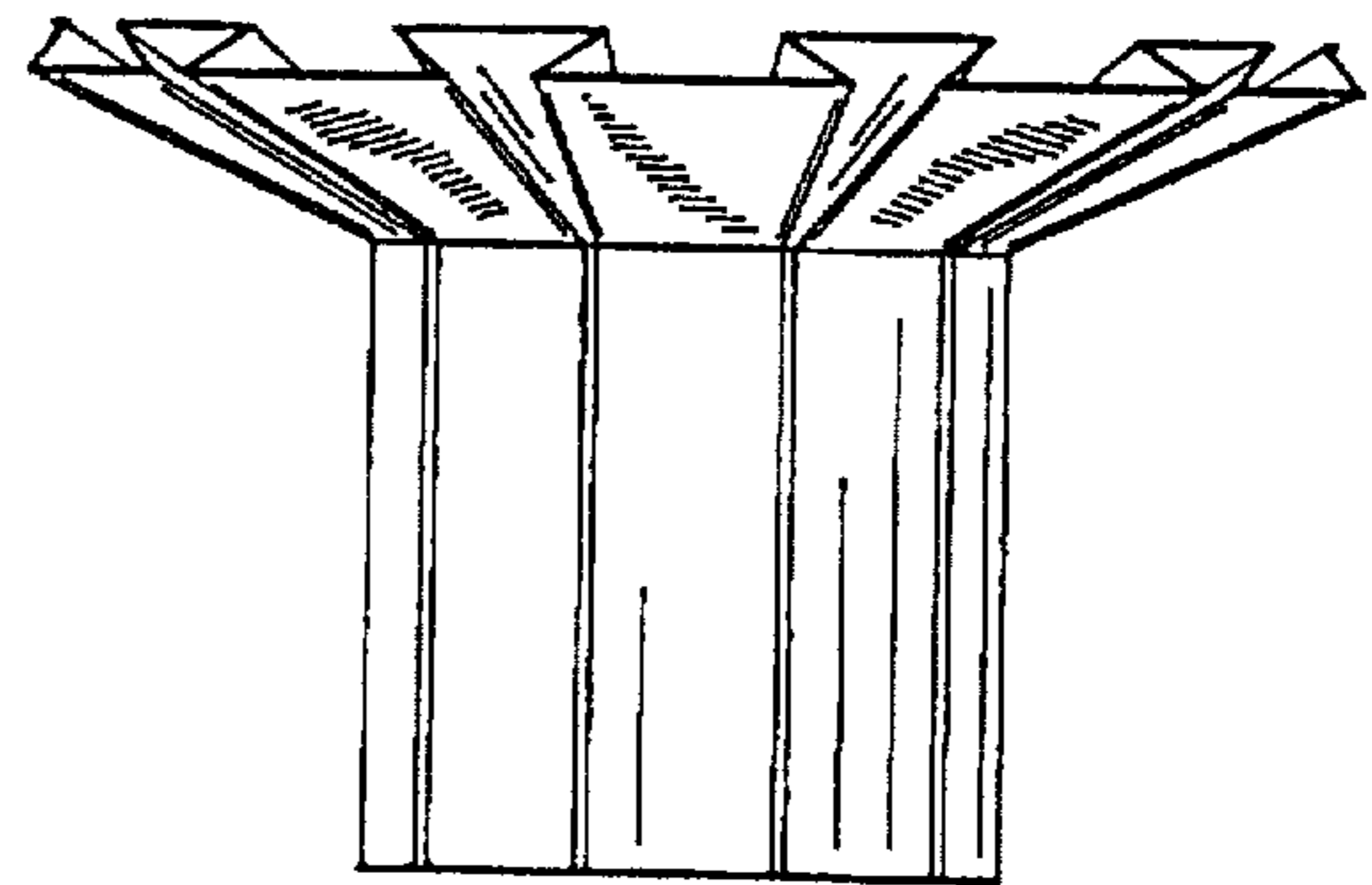

FIG. 2

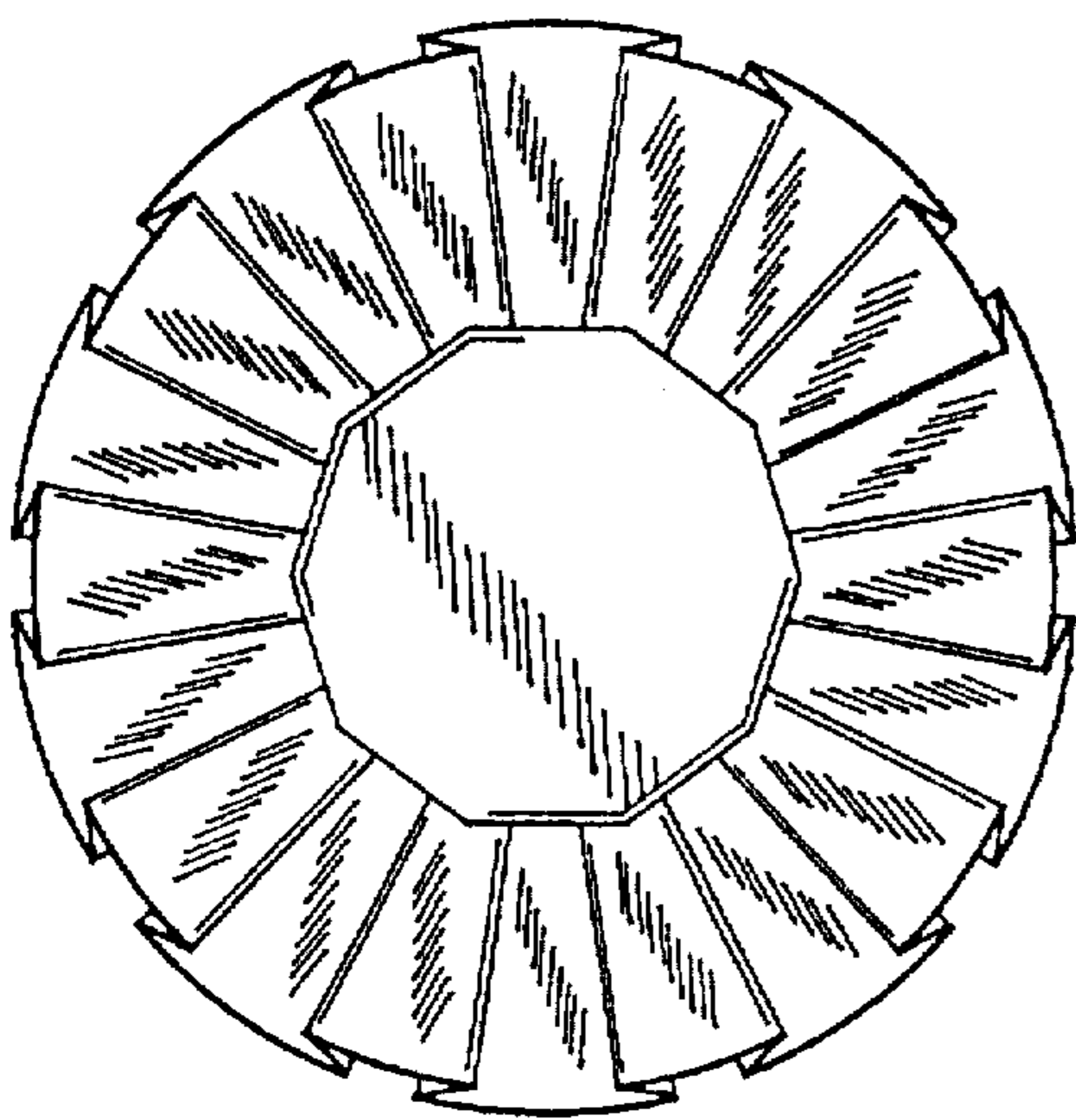

FIG. 3

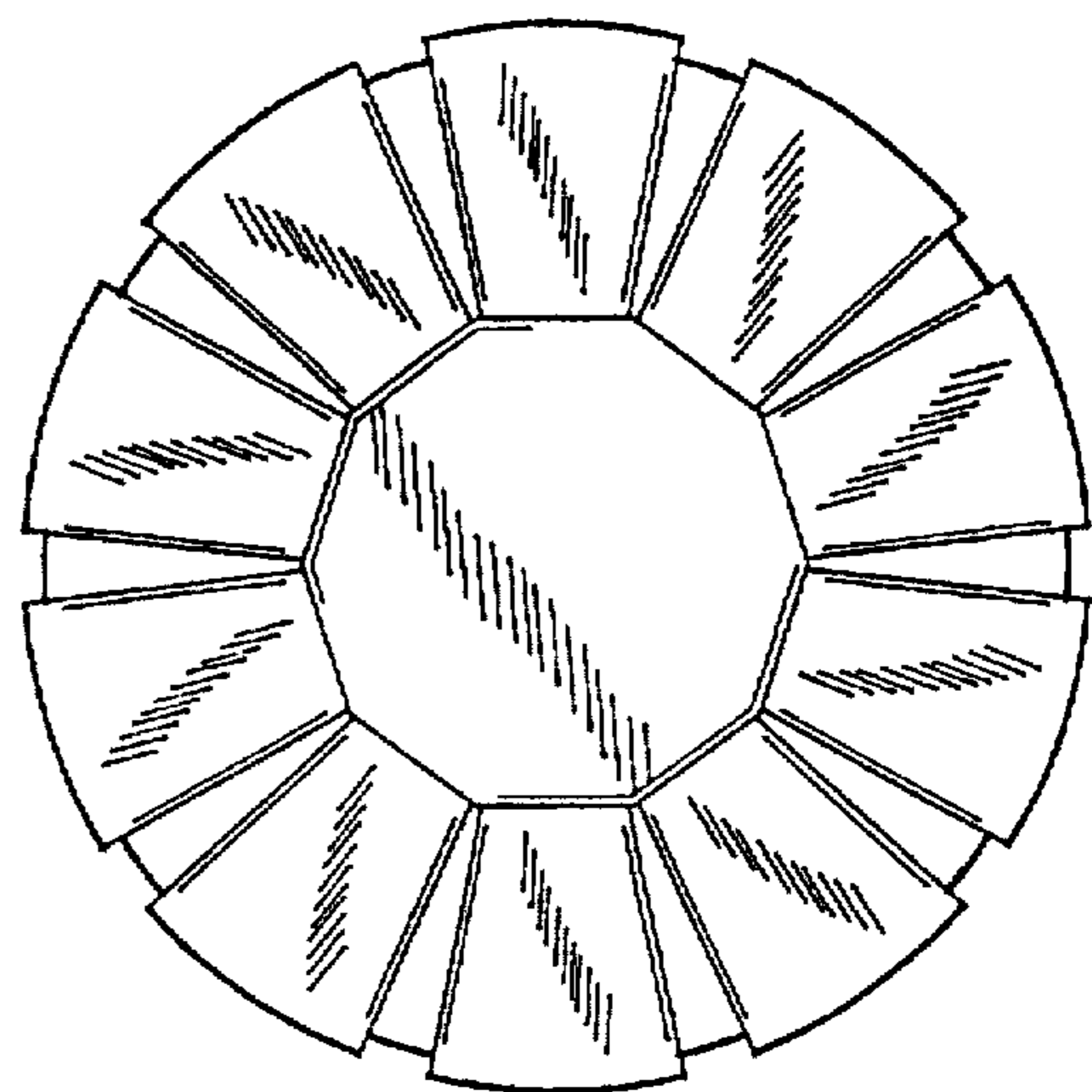

FIG. 4

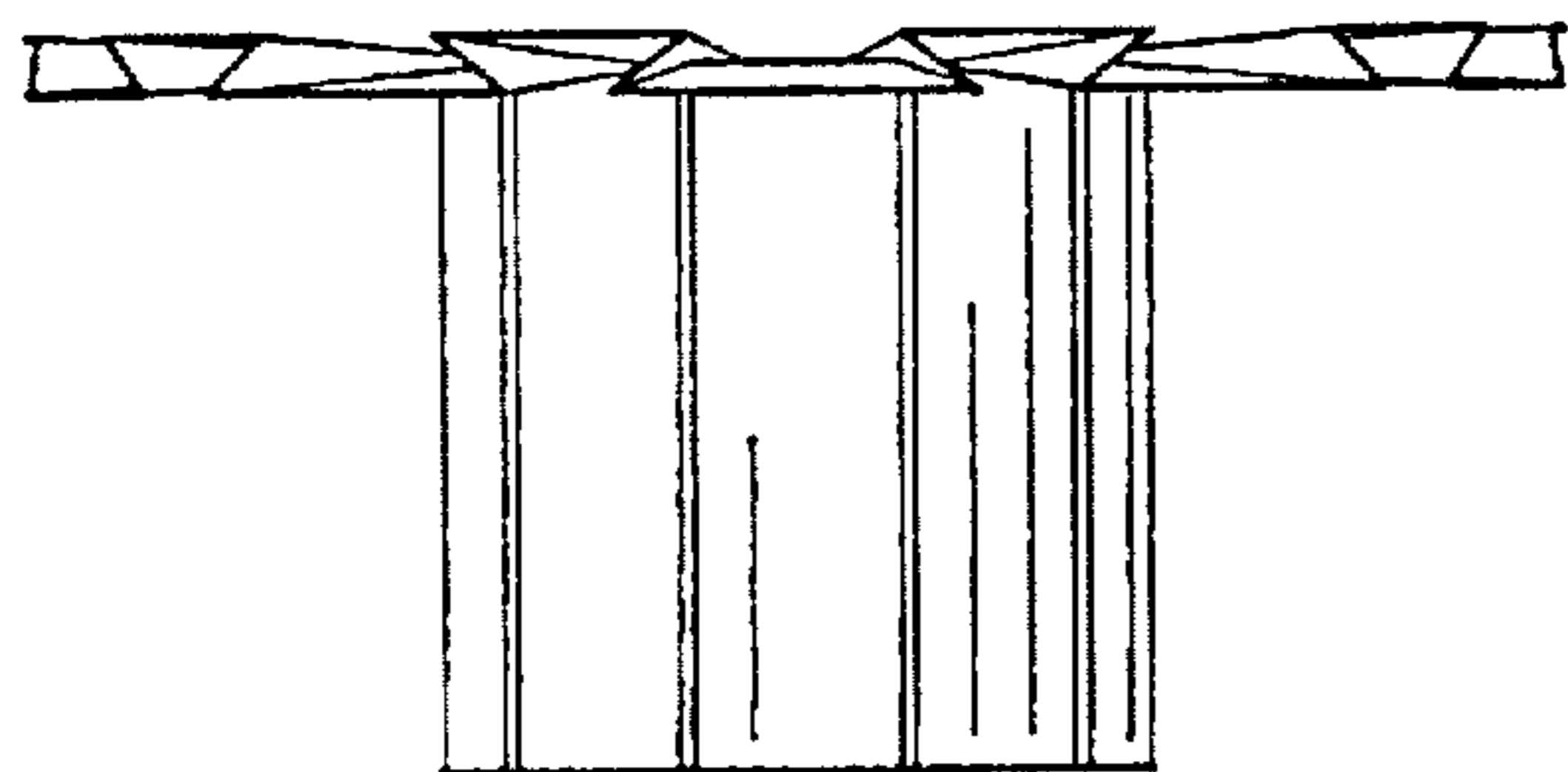

FIG. 5

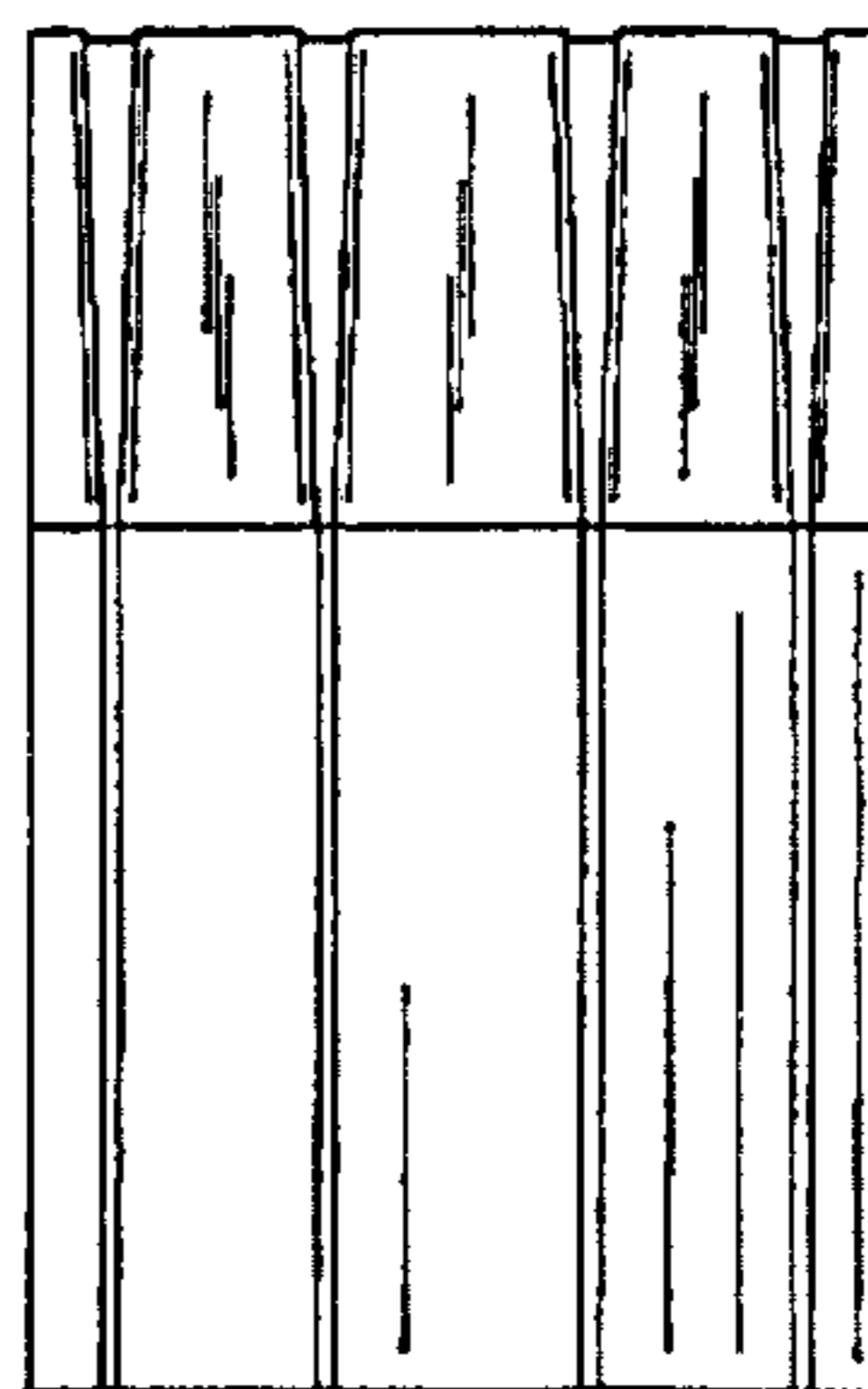

FIG. 6

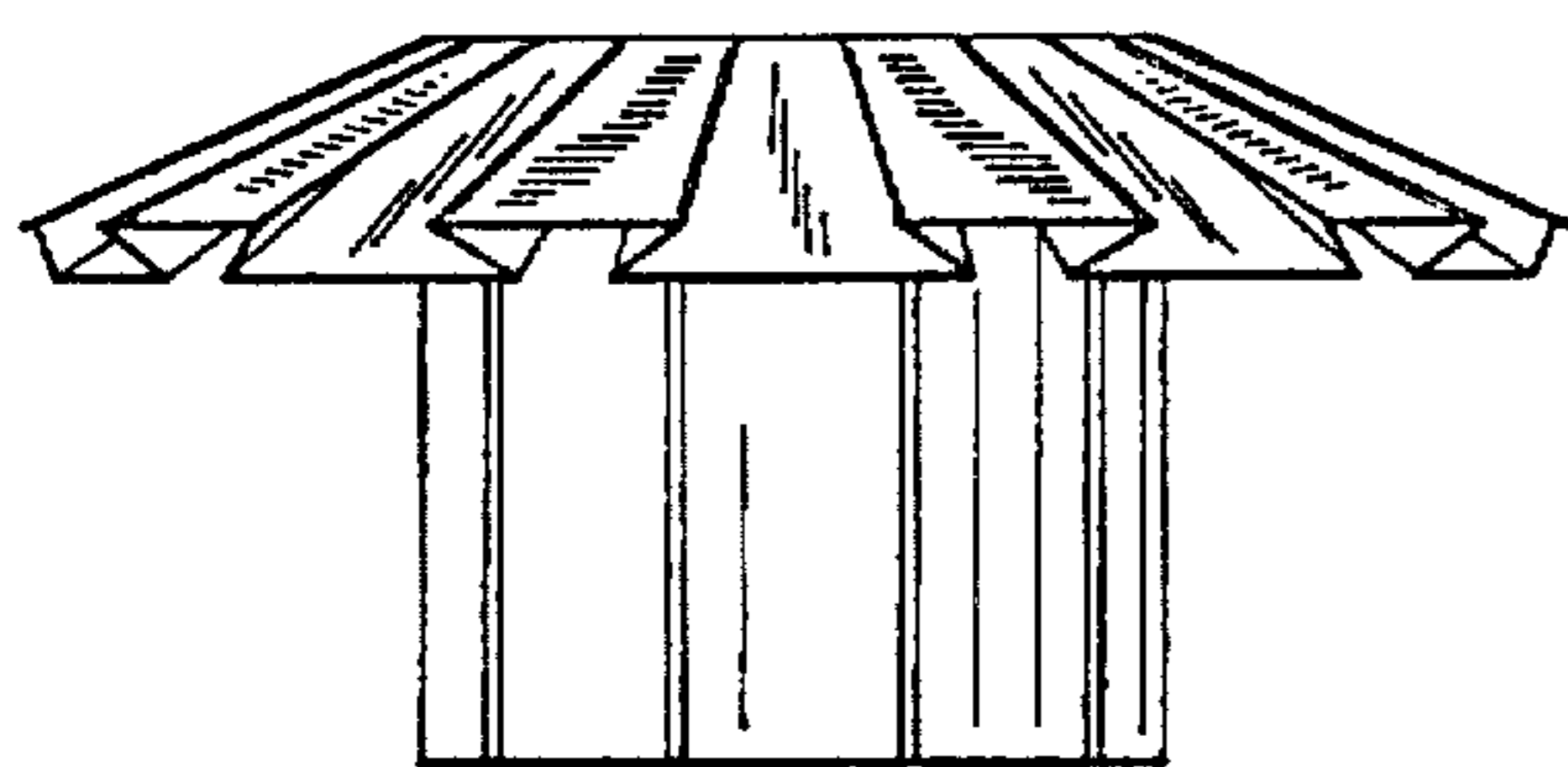

FIG. 7

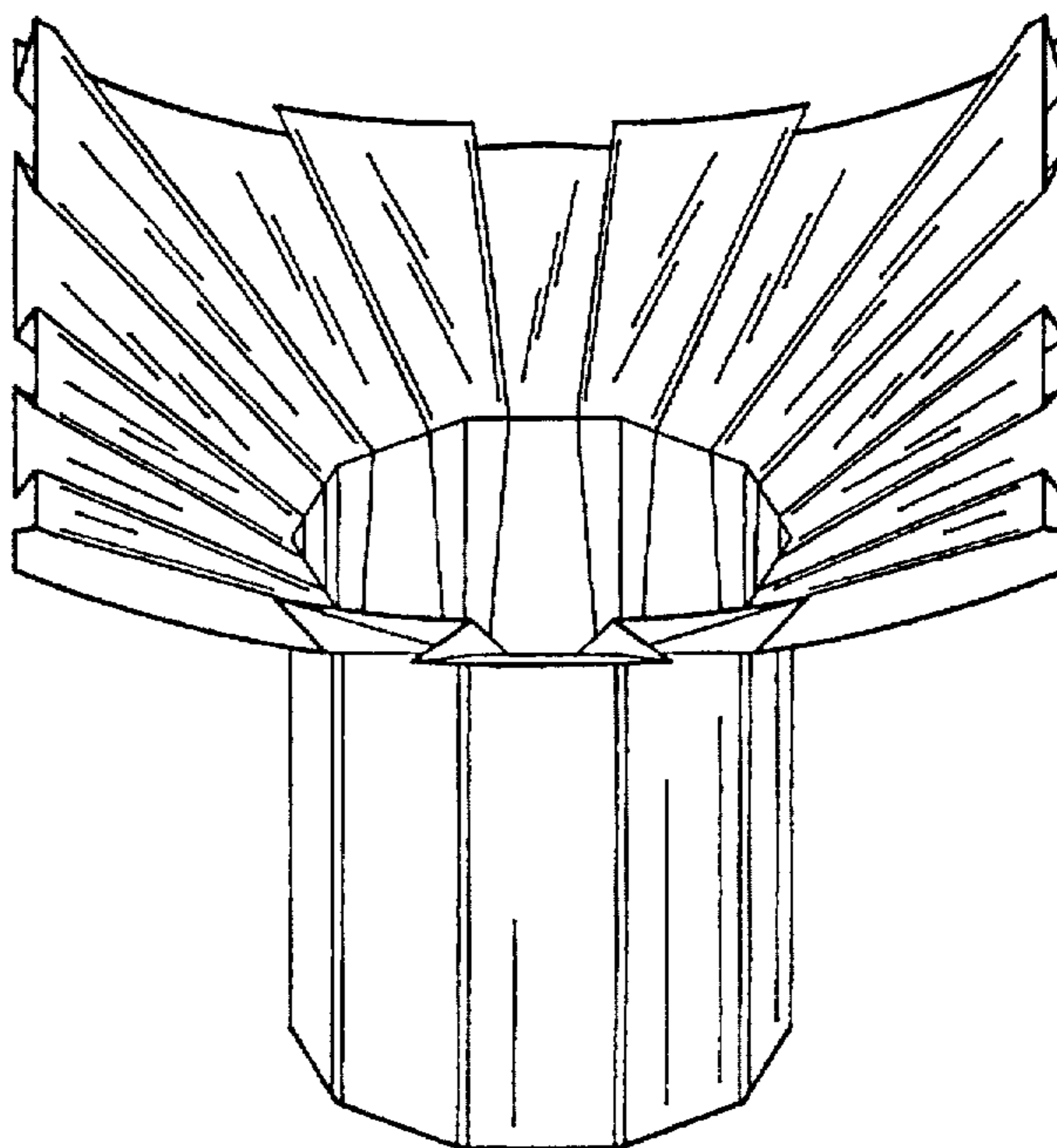

FIG. 8

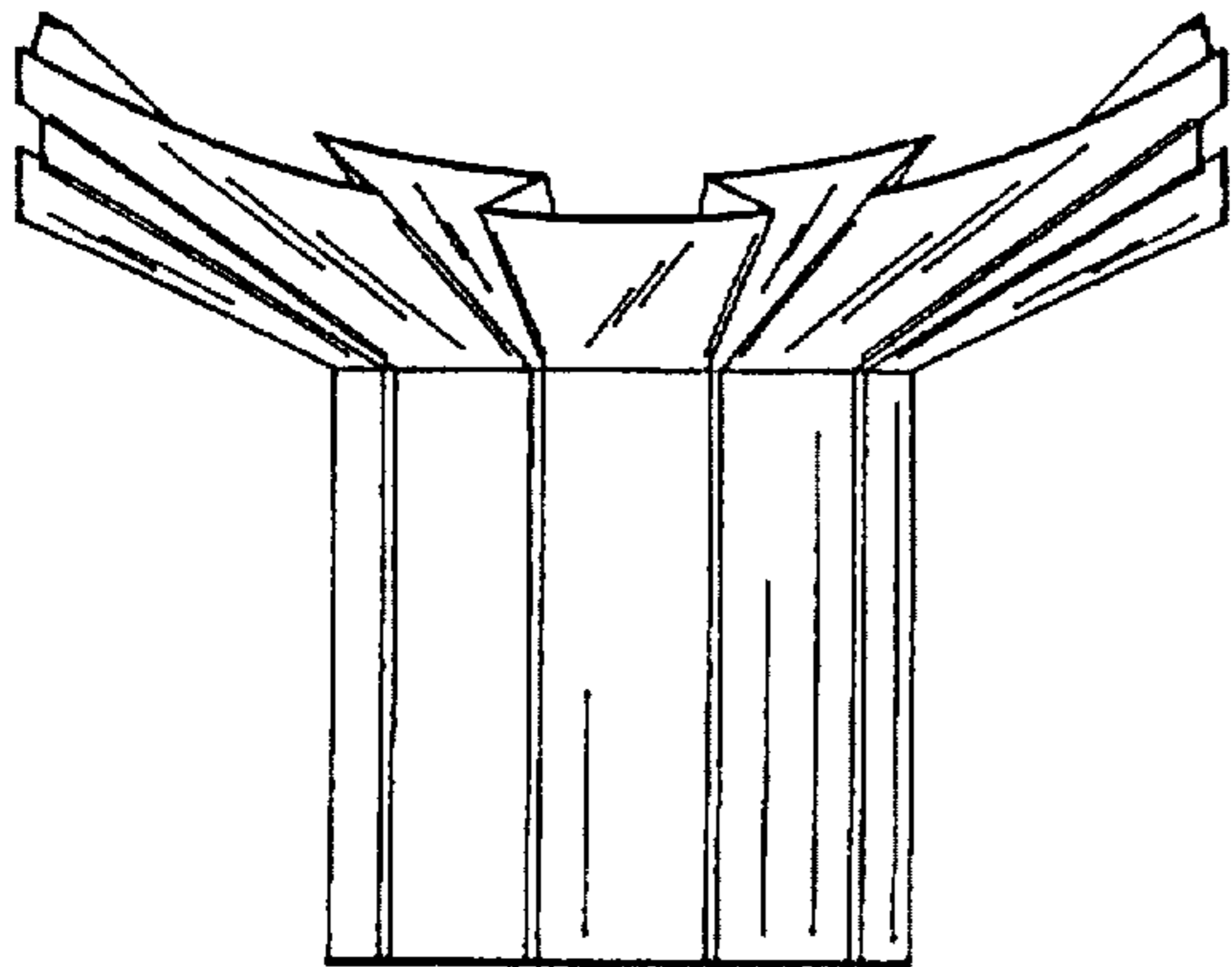

FIG. 9

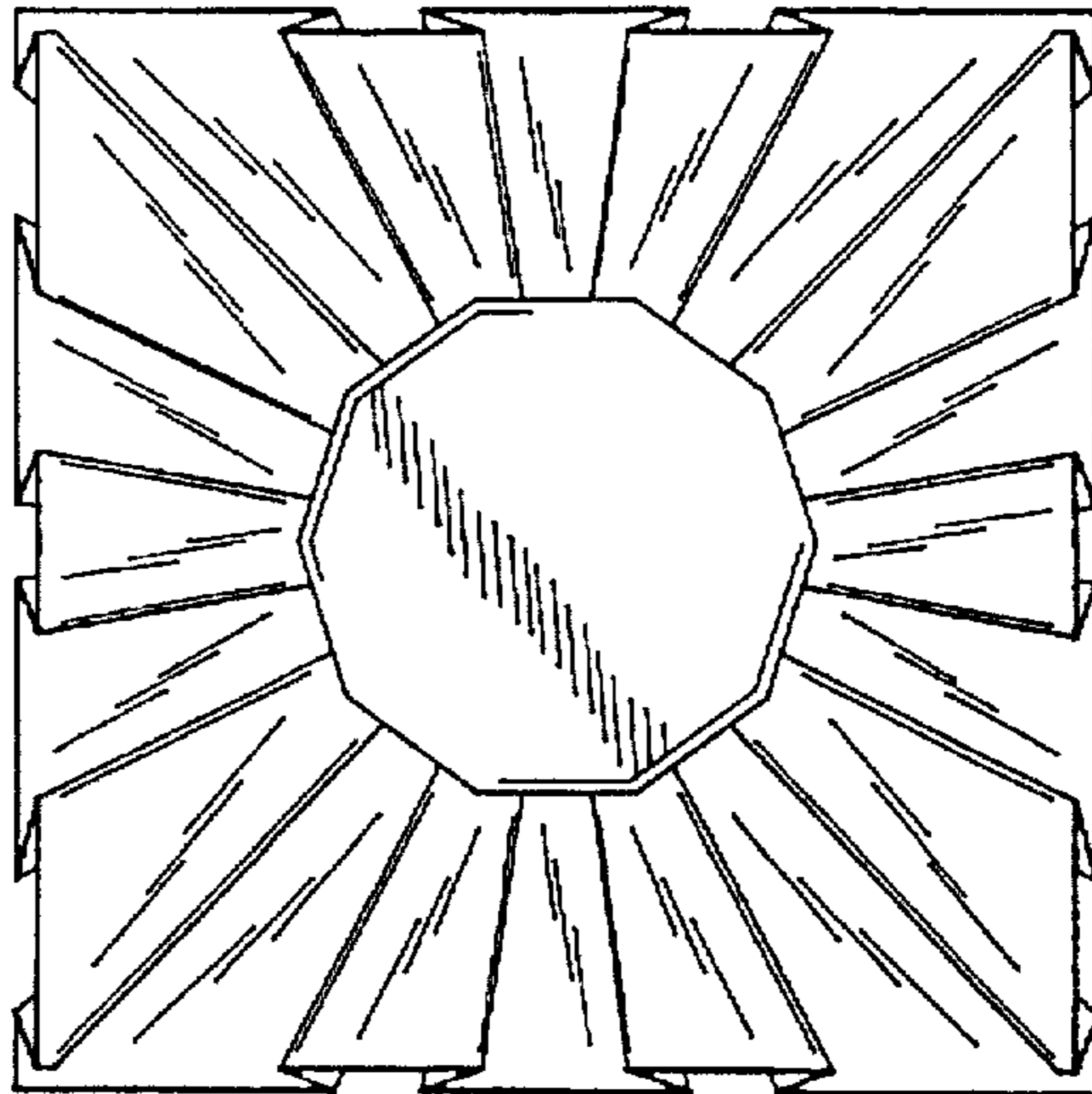

FIG. 10

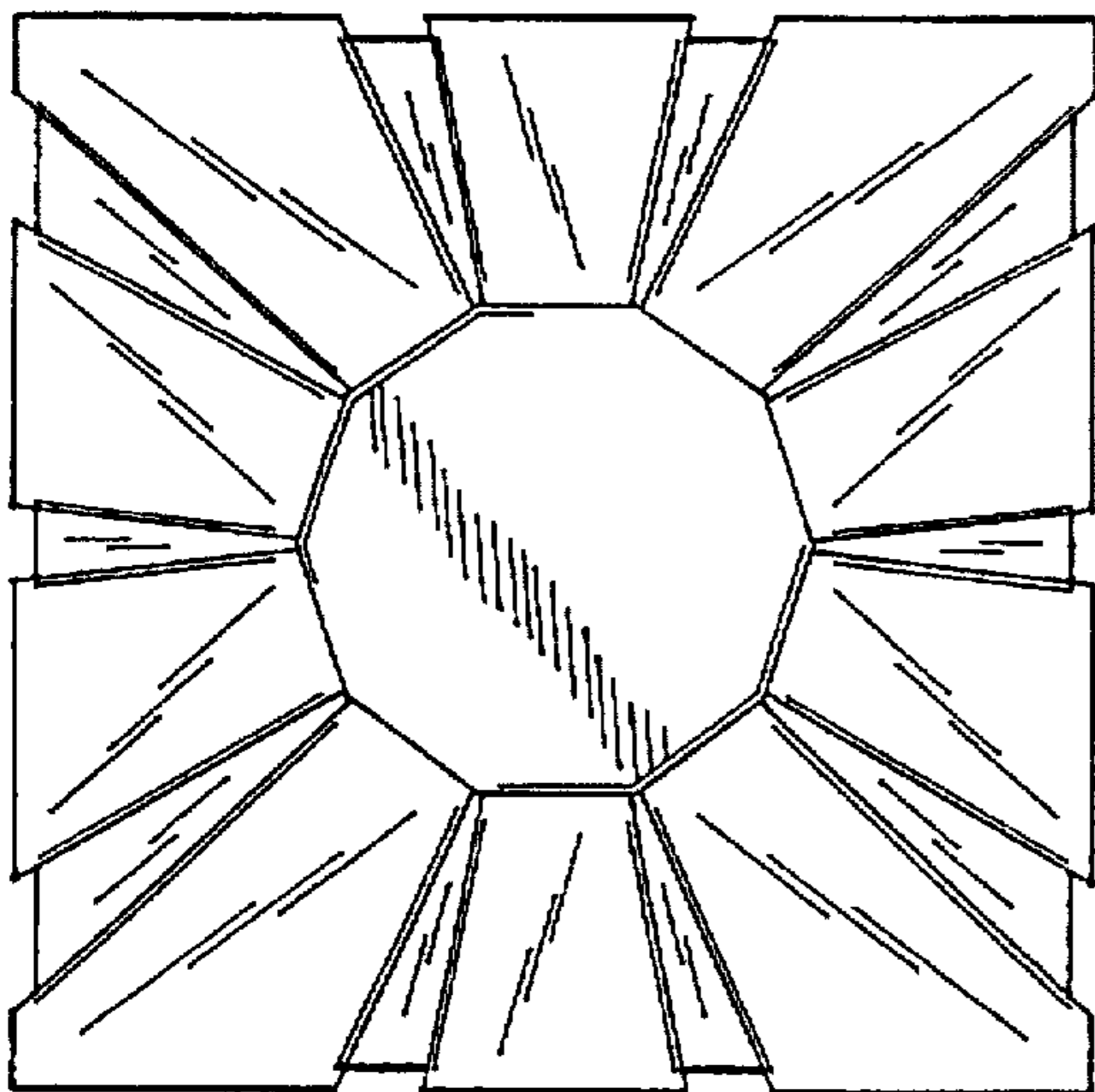

FIG. 11

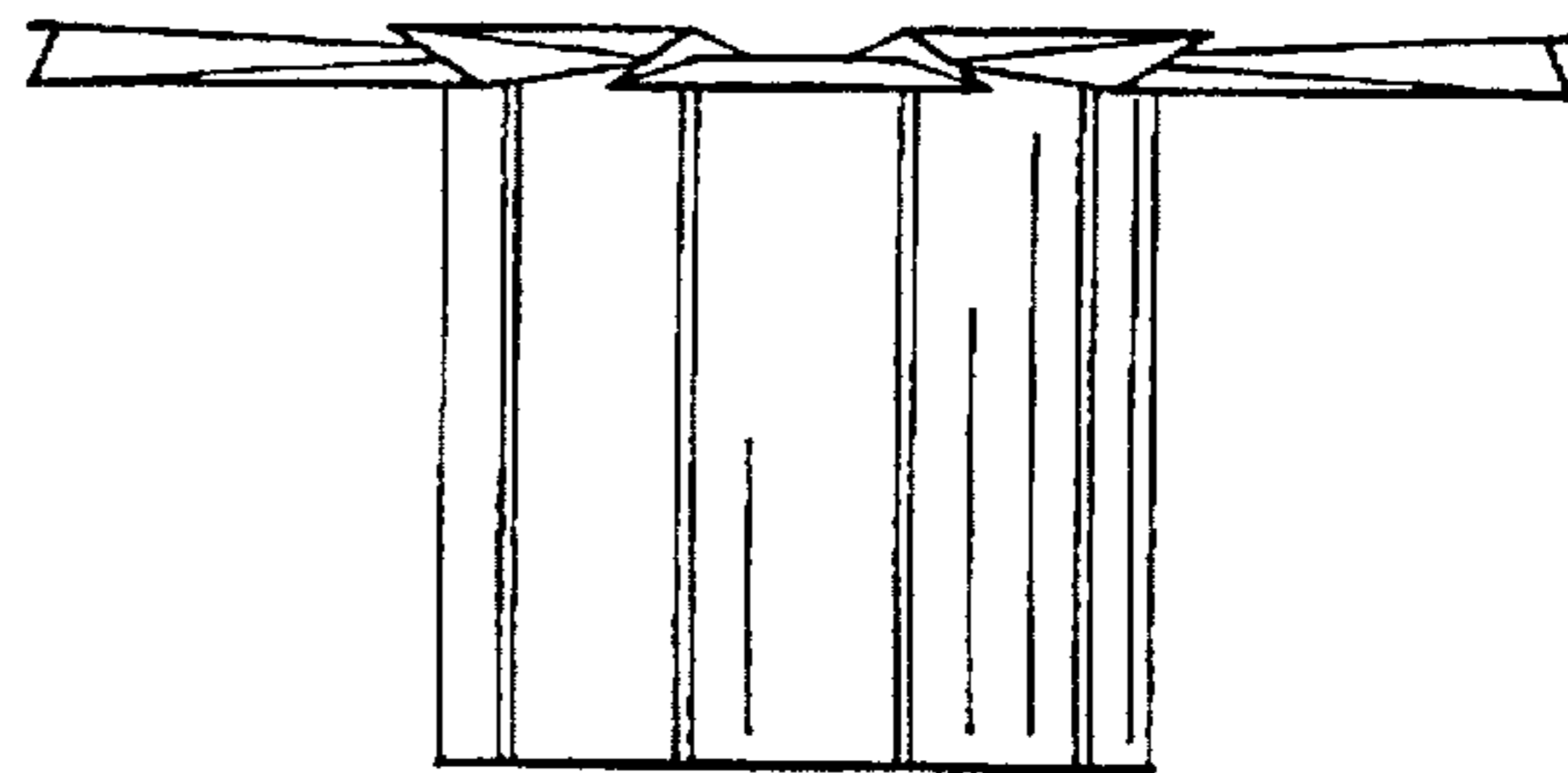

FIG. 12

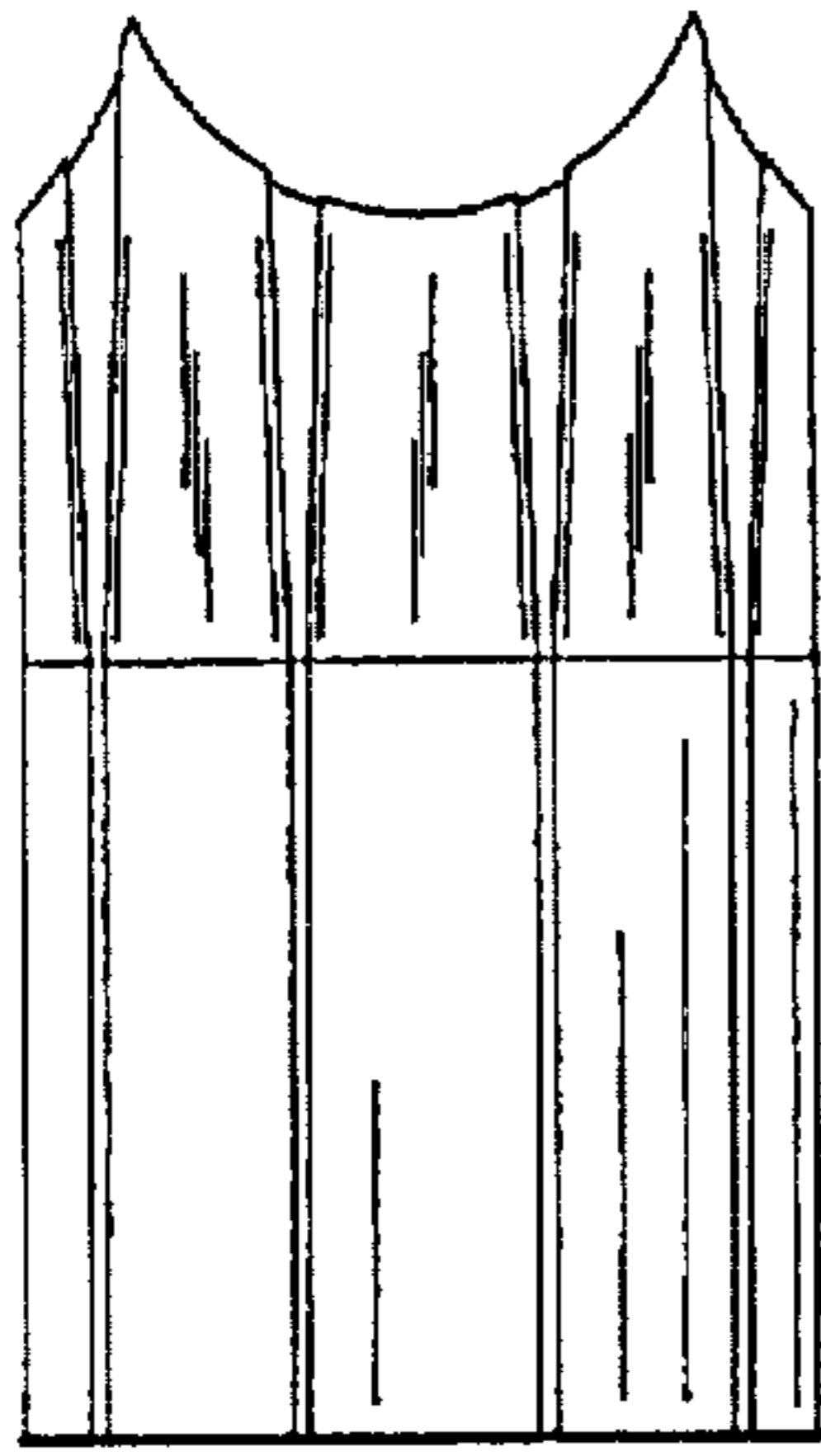

FIG. 13

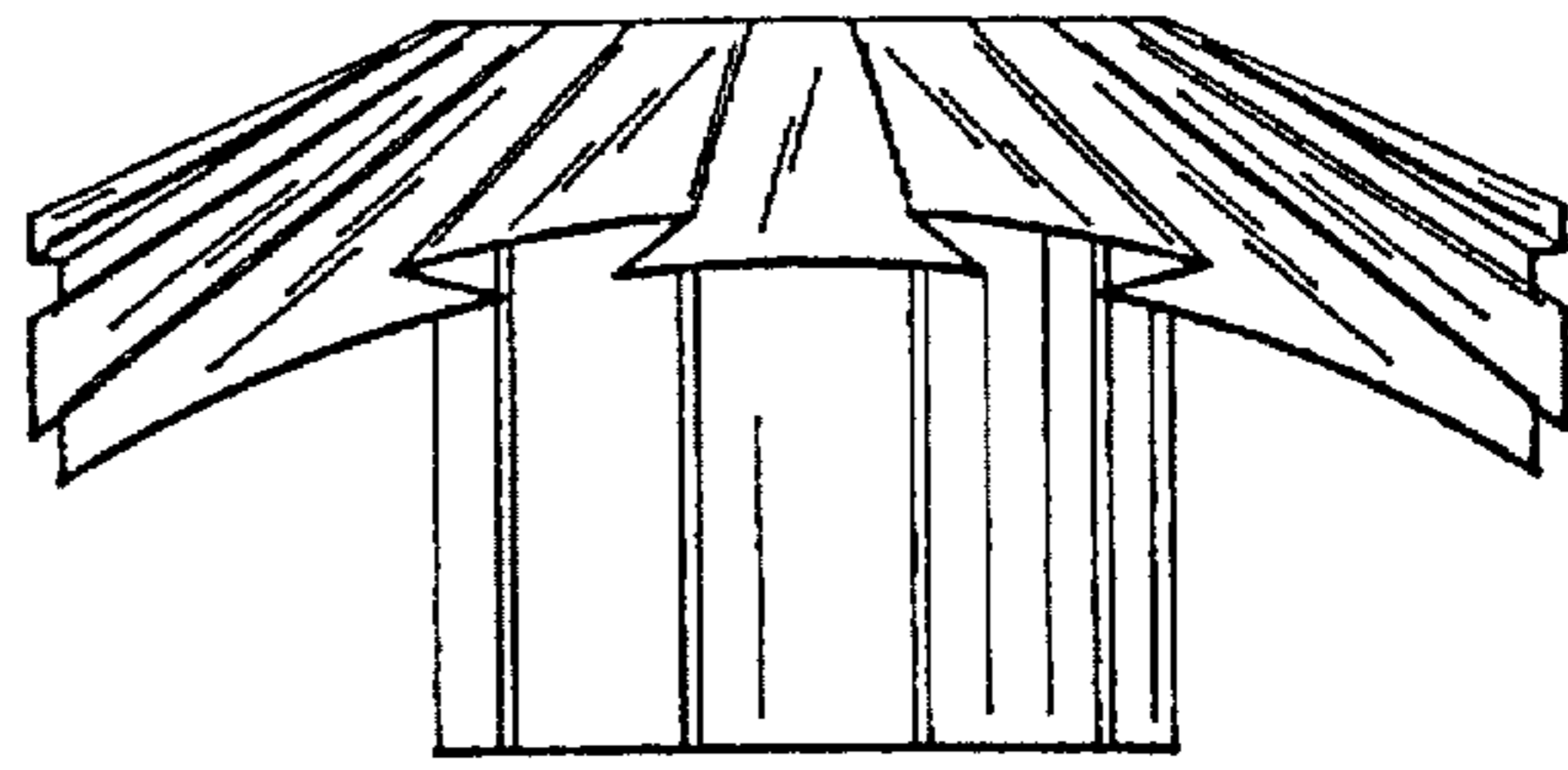

FIG. 14

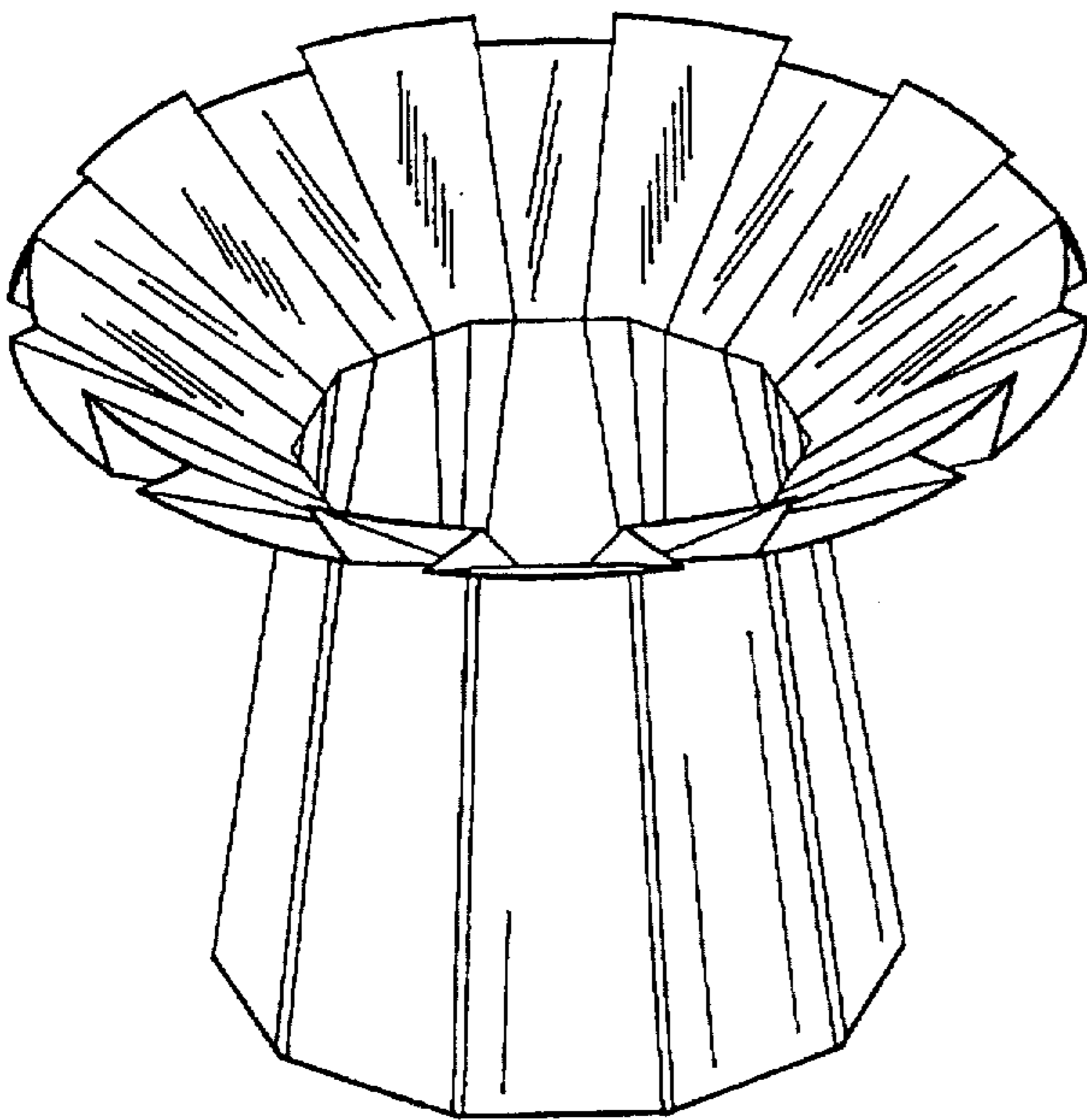

FIG. 15

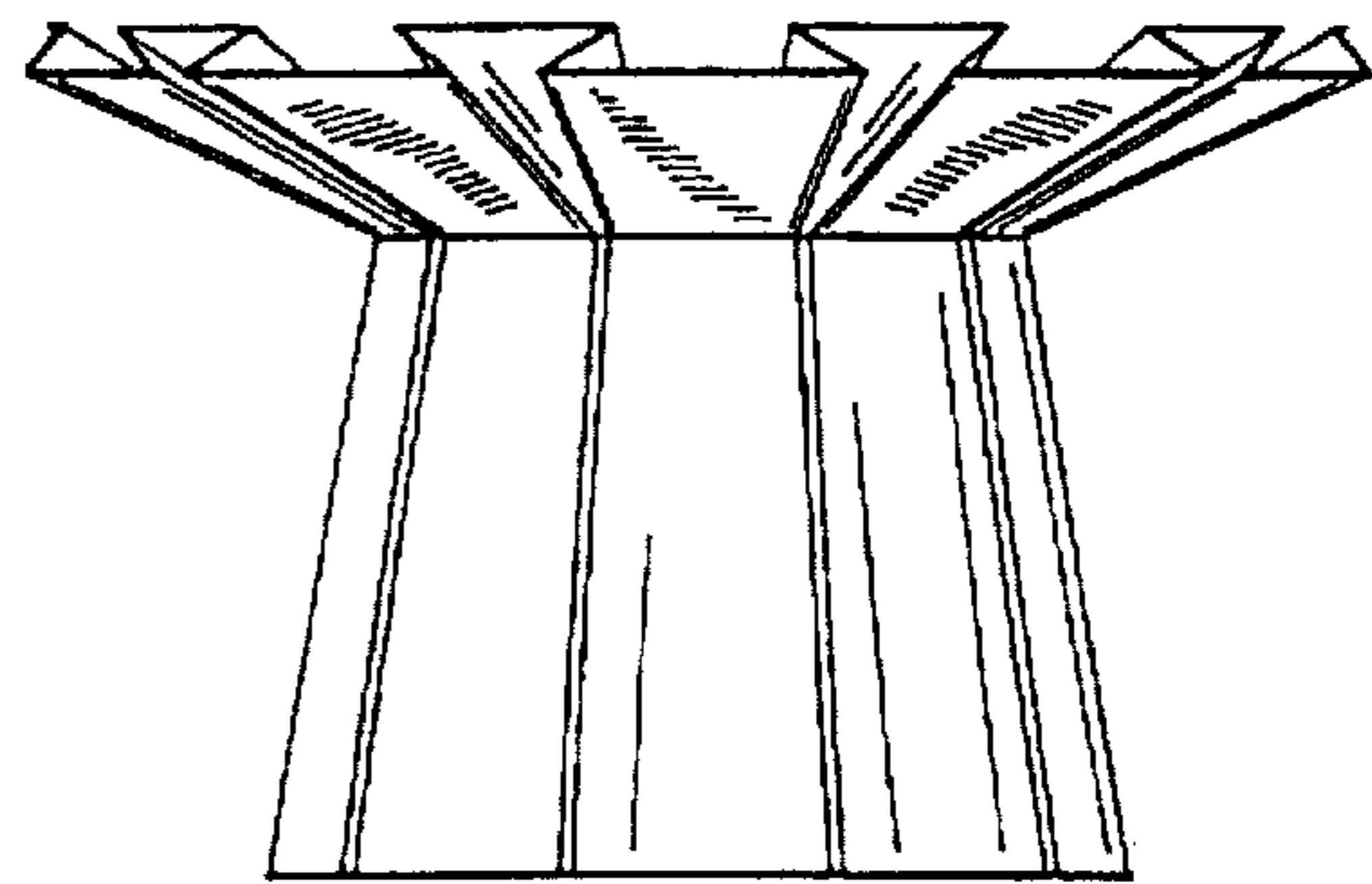

FIG. 16

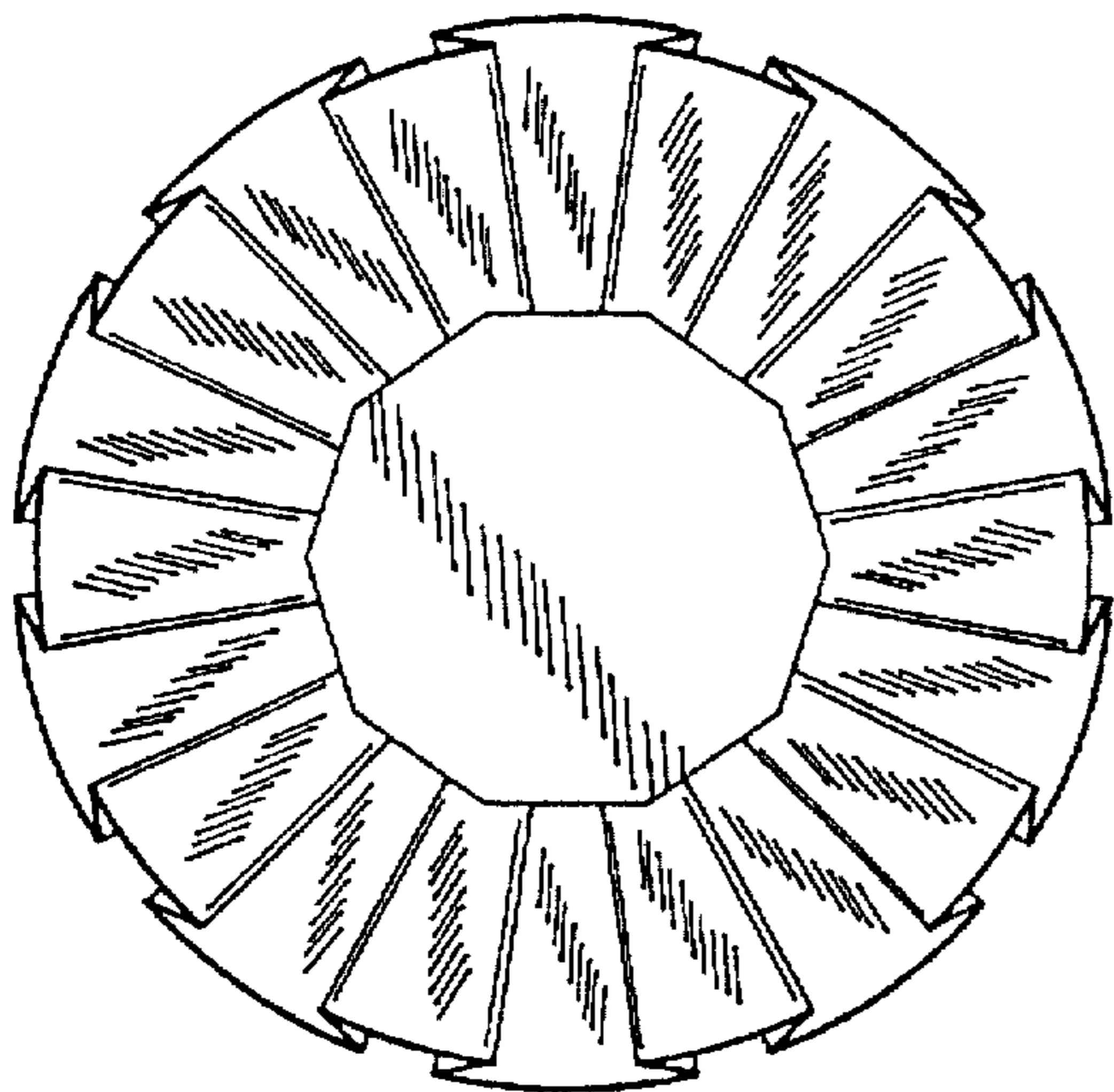

FIG. 17

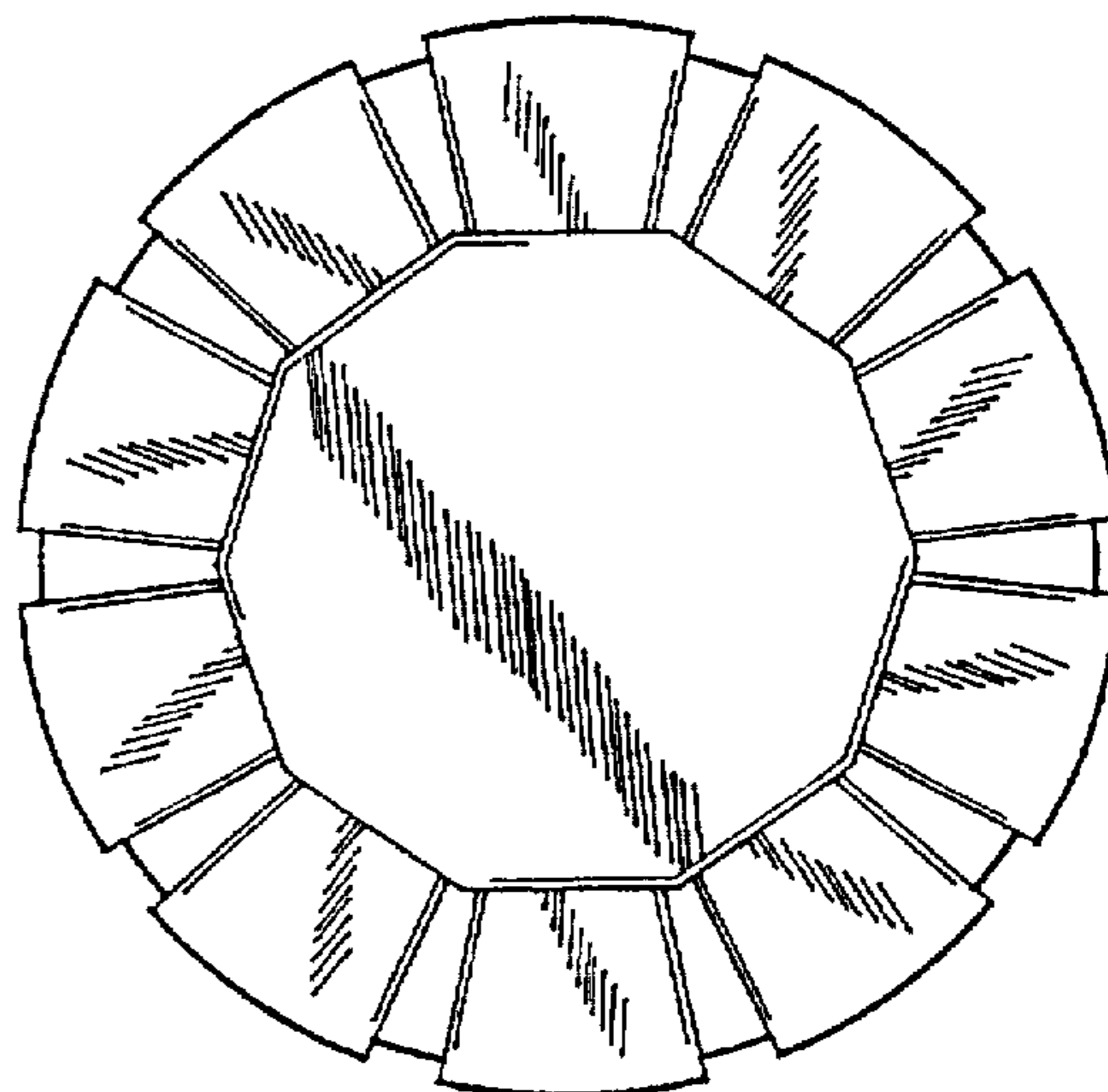

FIG. 18

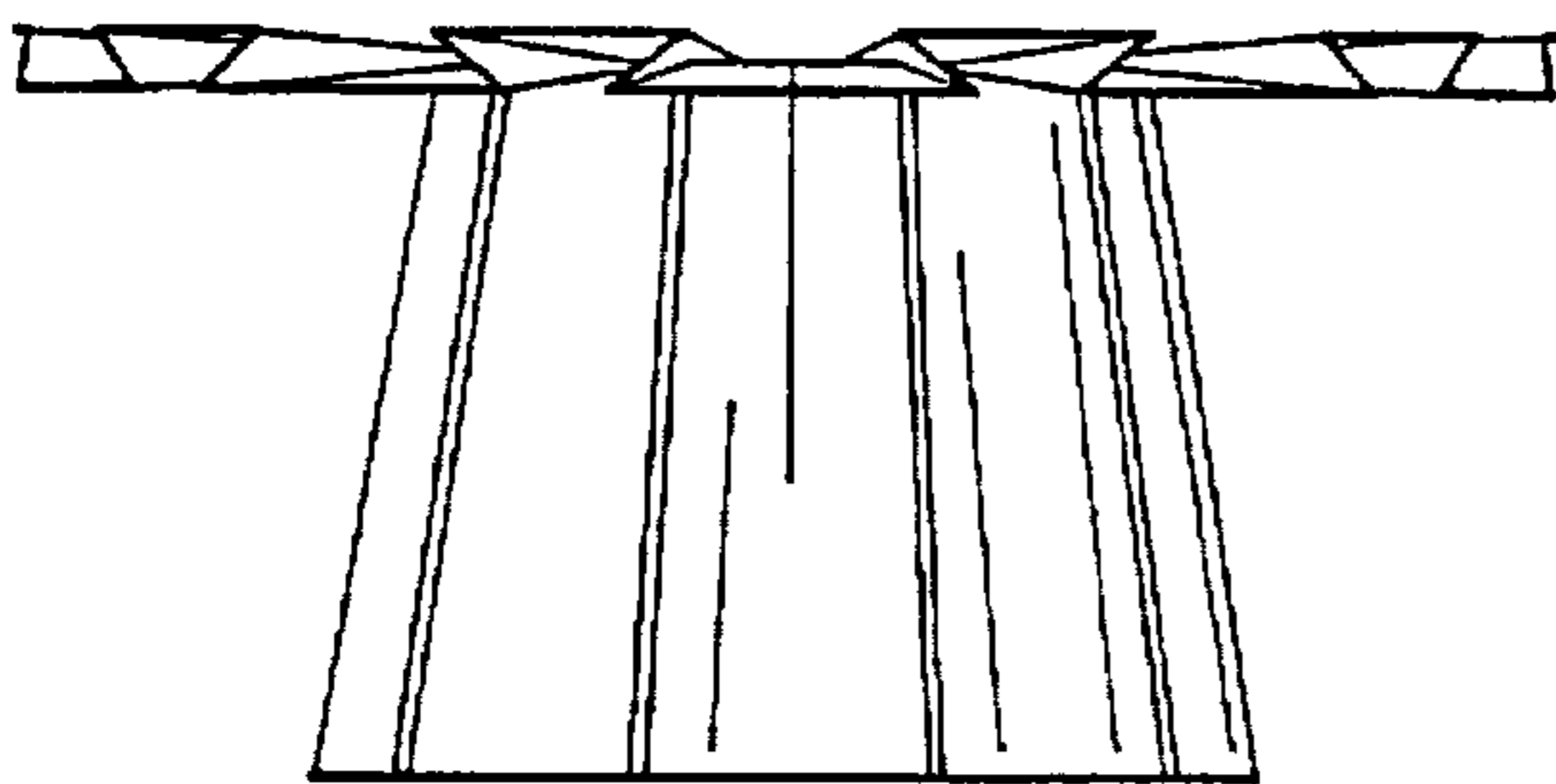

FIG. 19

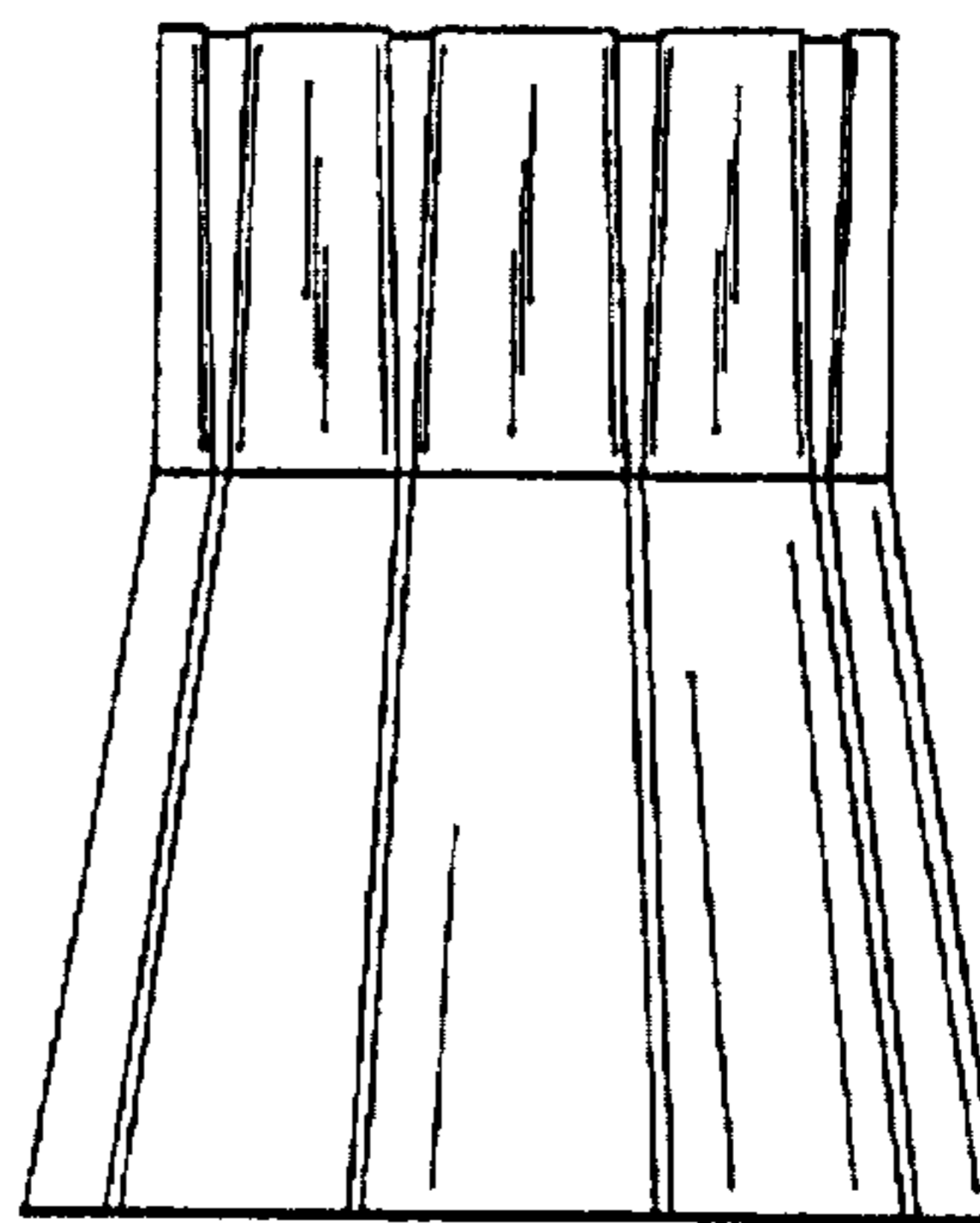

FIG. 20

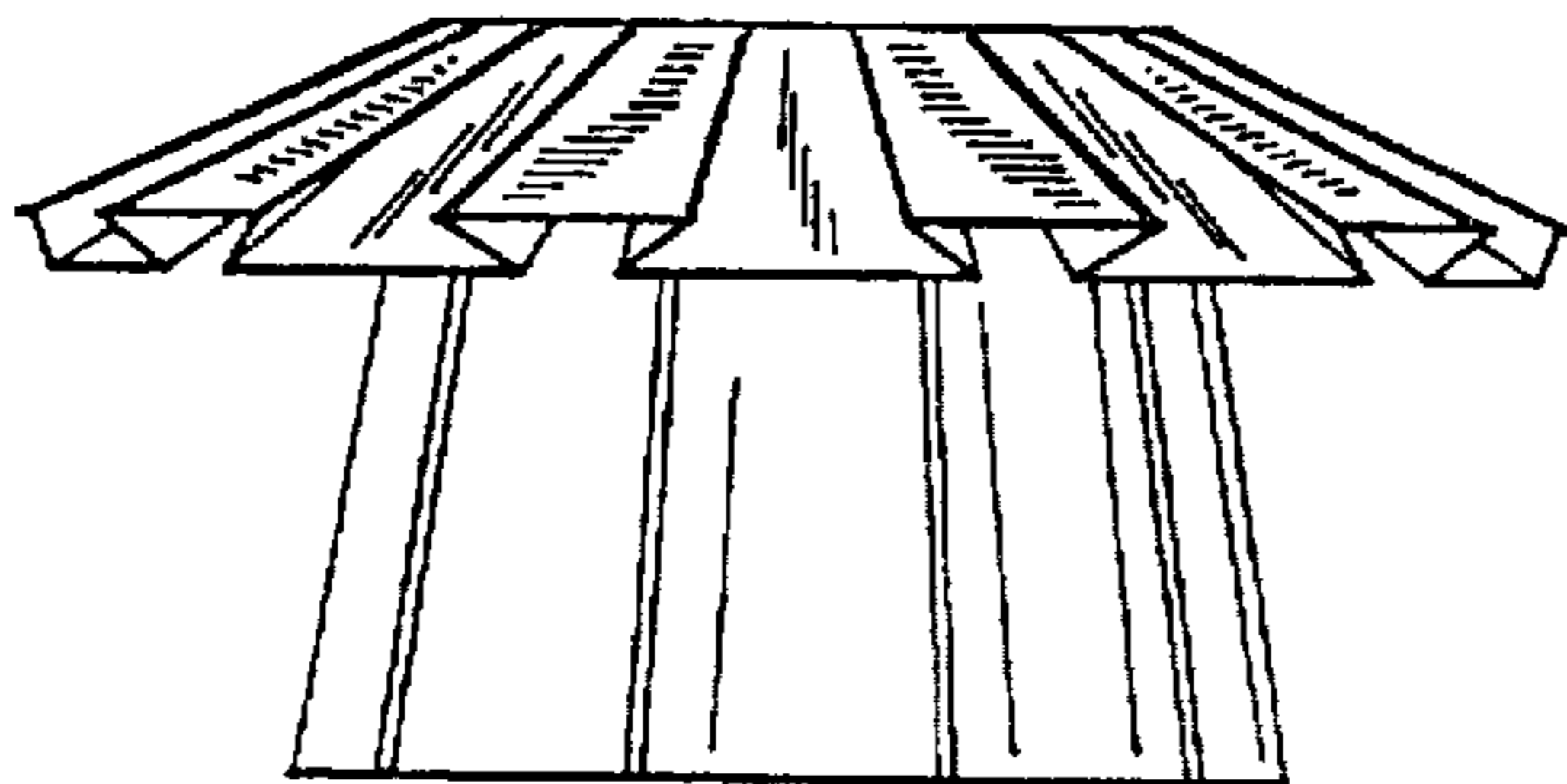

FIG. 21

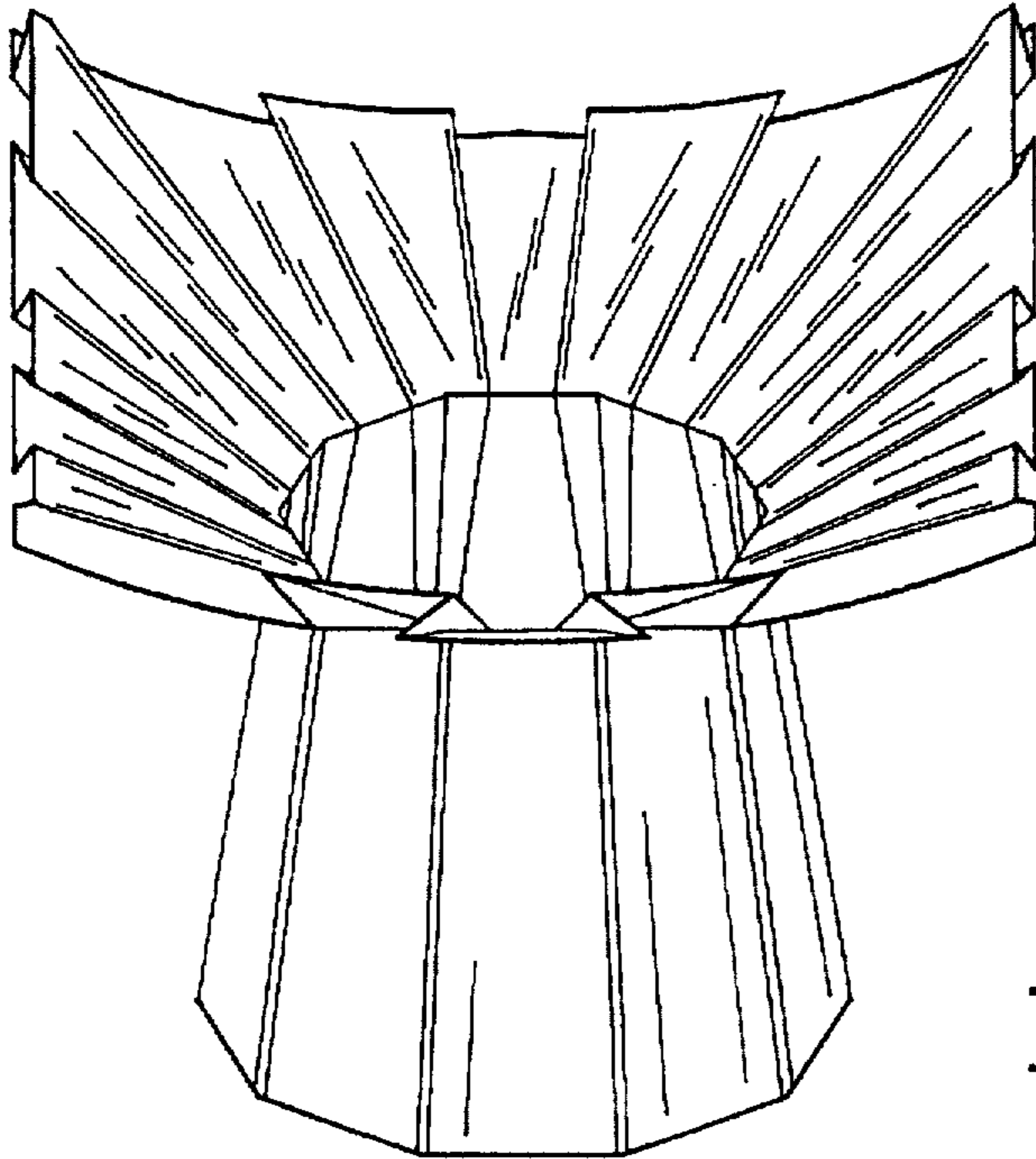

FIG. 22

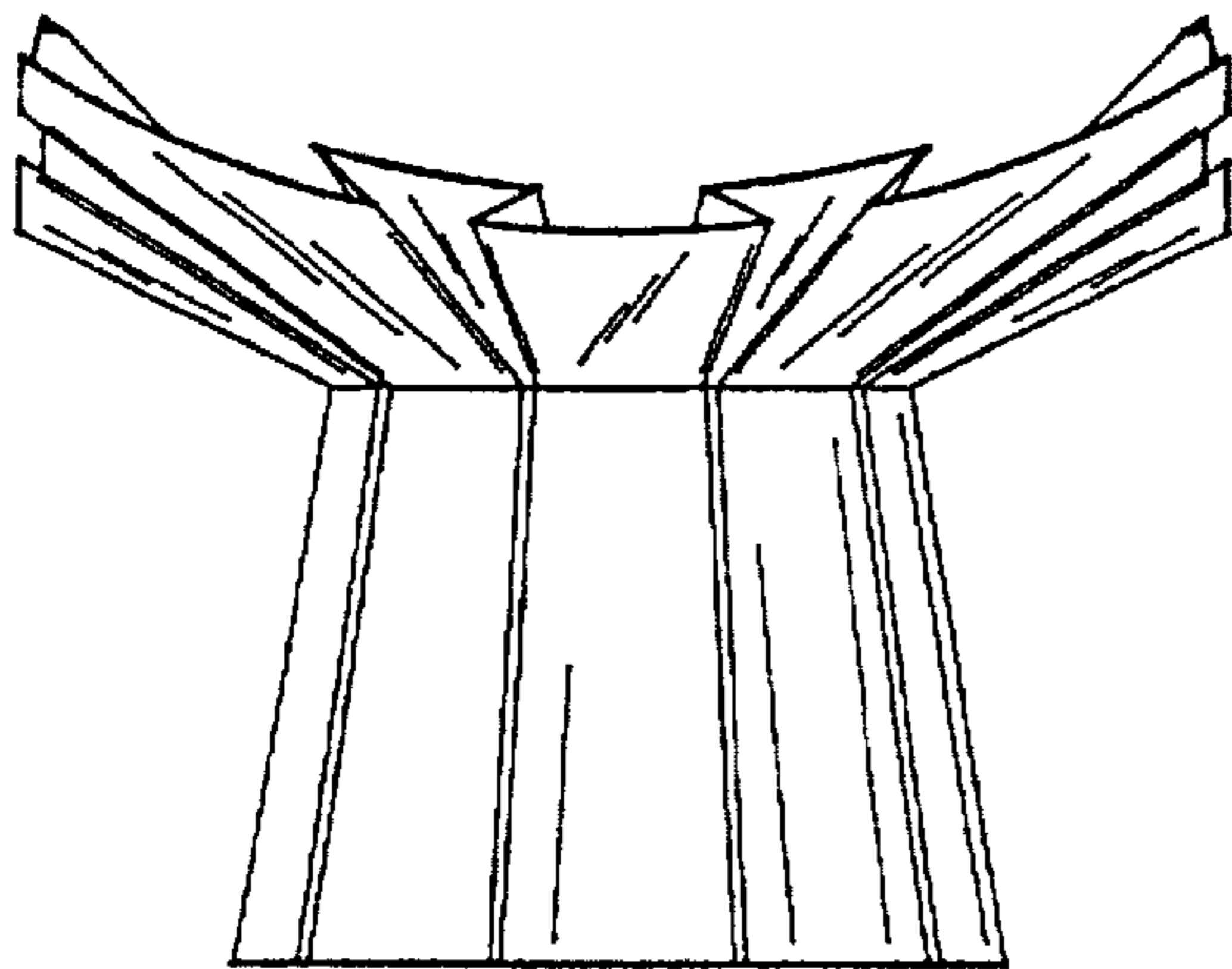

FIG. 23

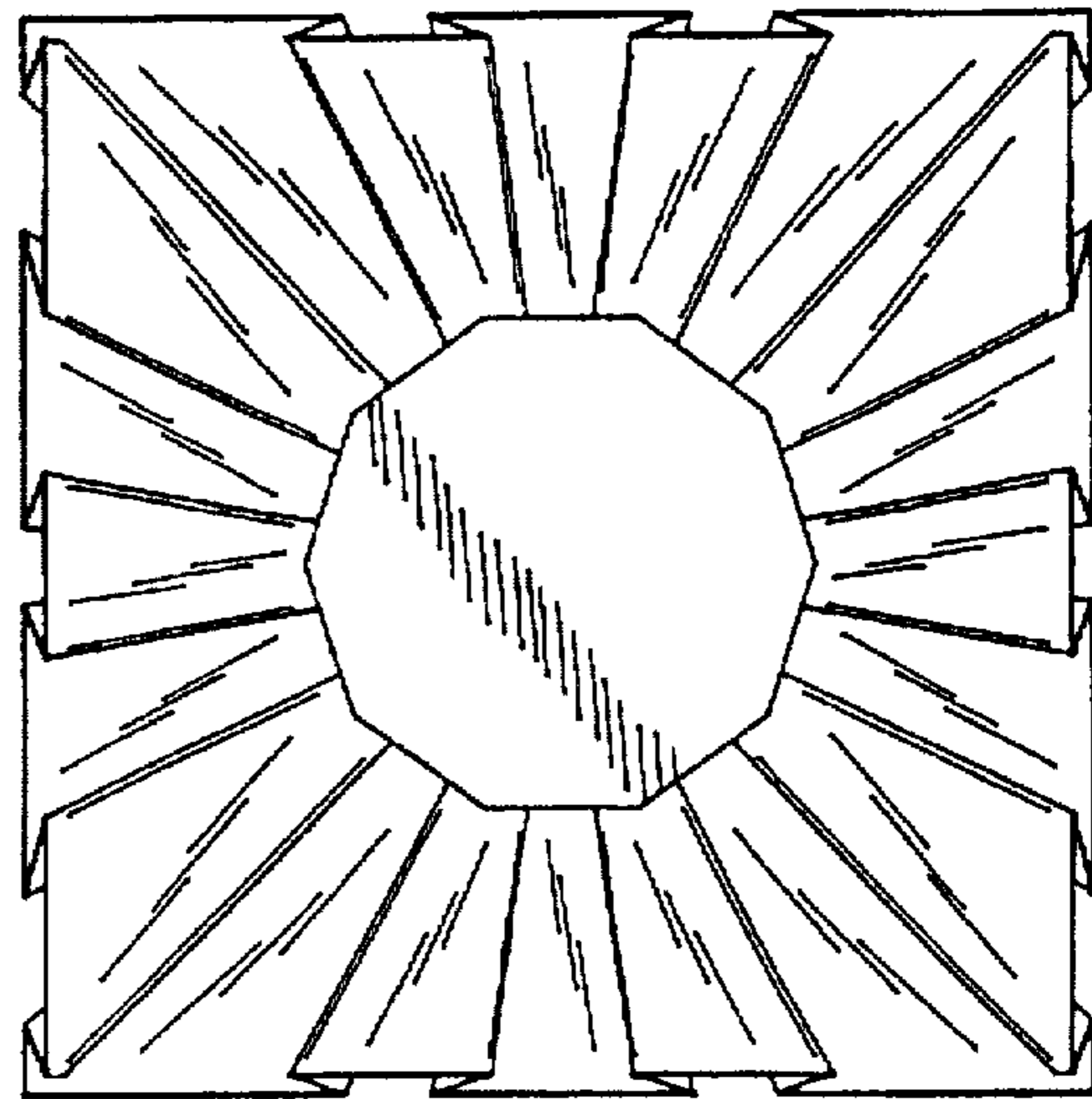

FIG. 24

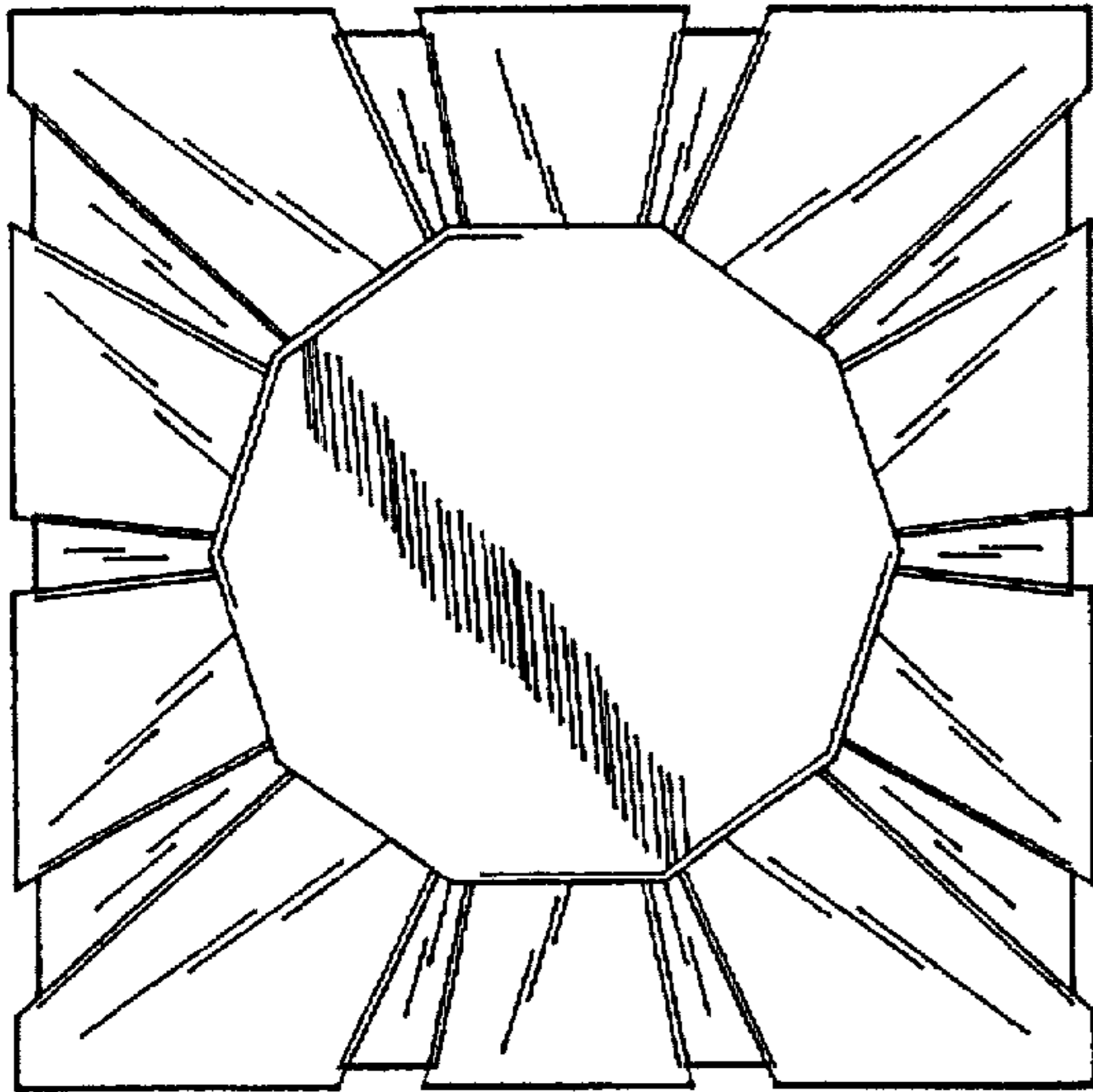

FIG. 25

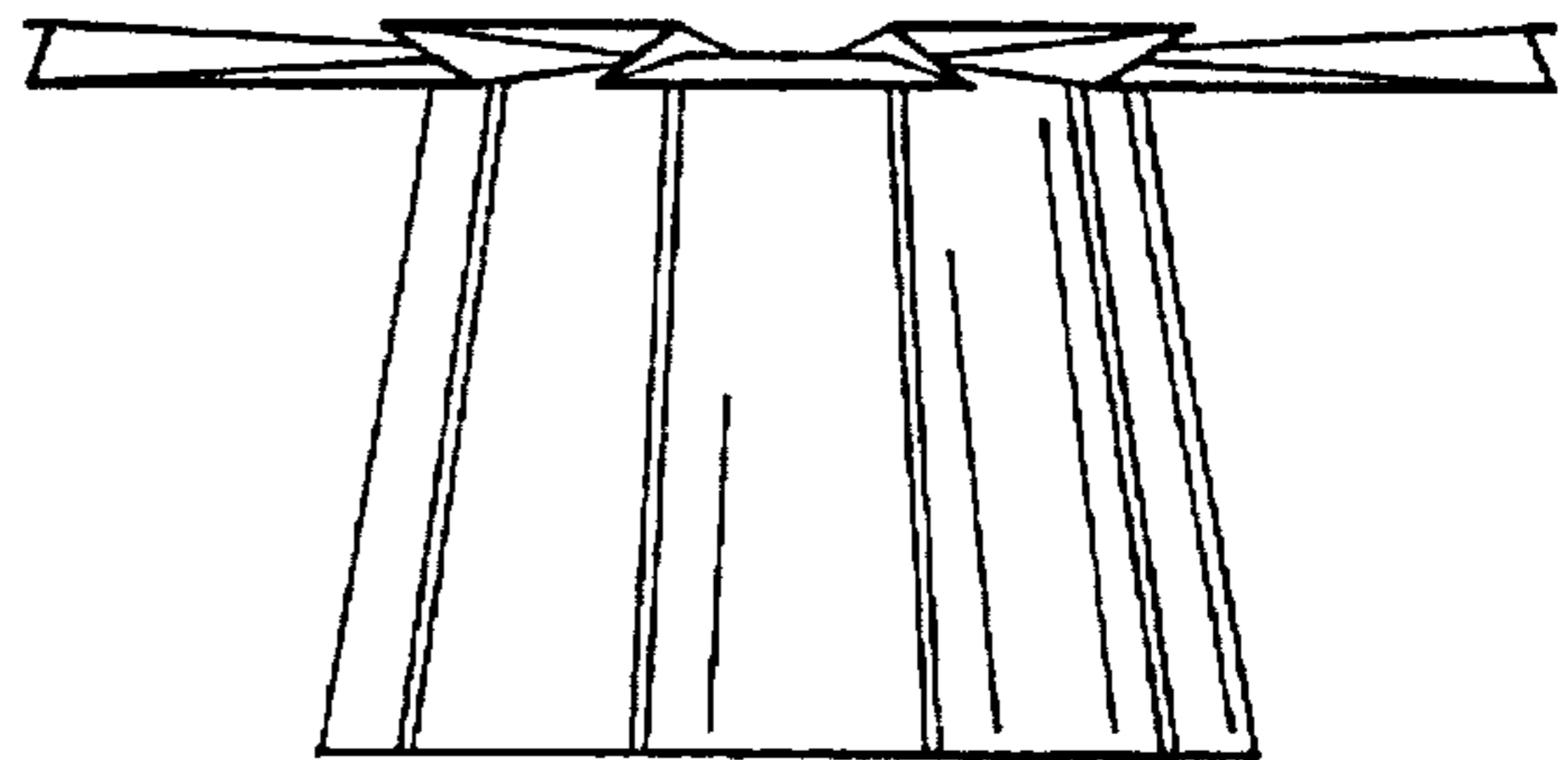

FIG. 26

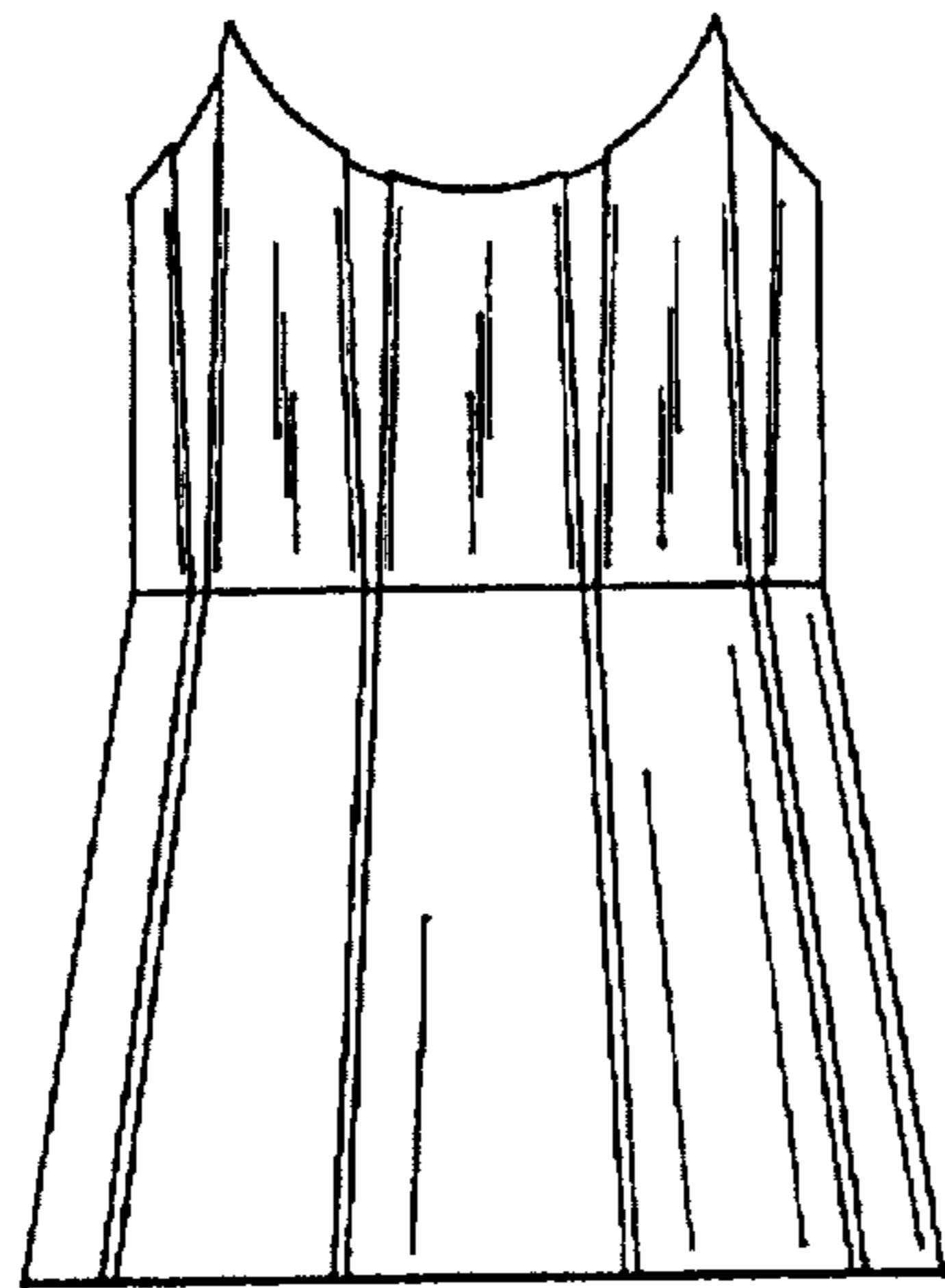

FIG. 27

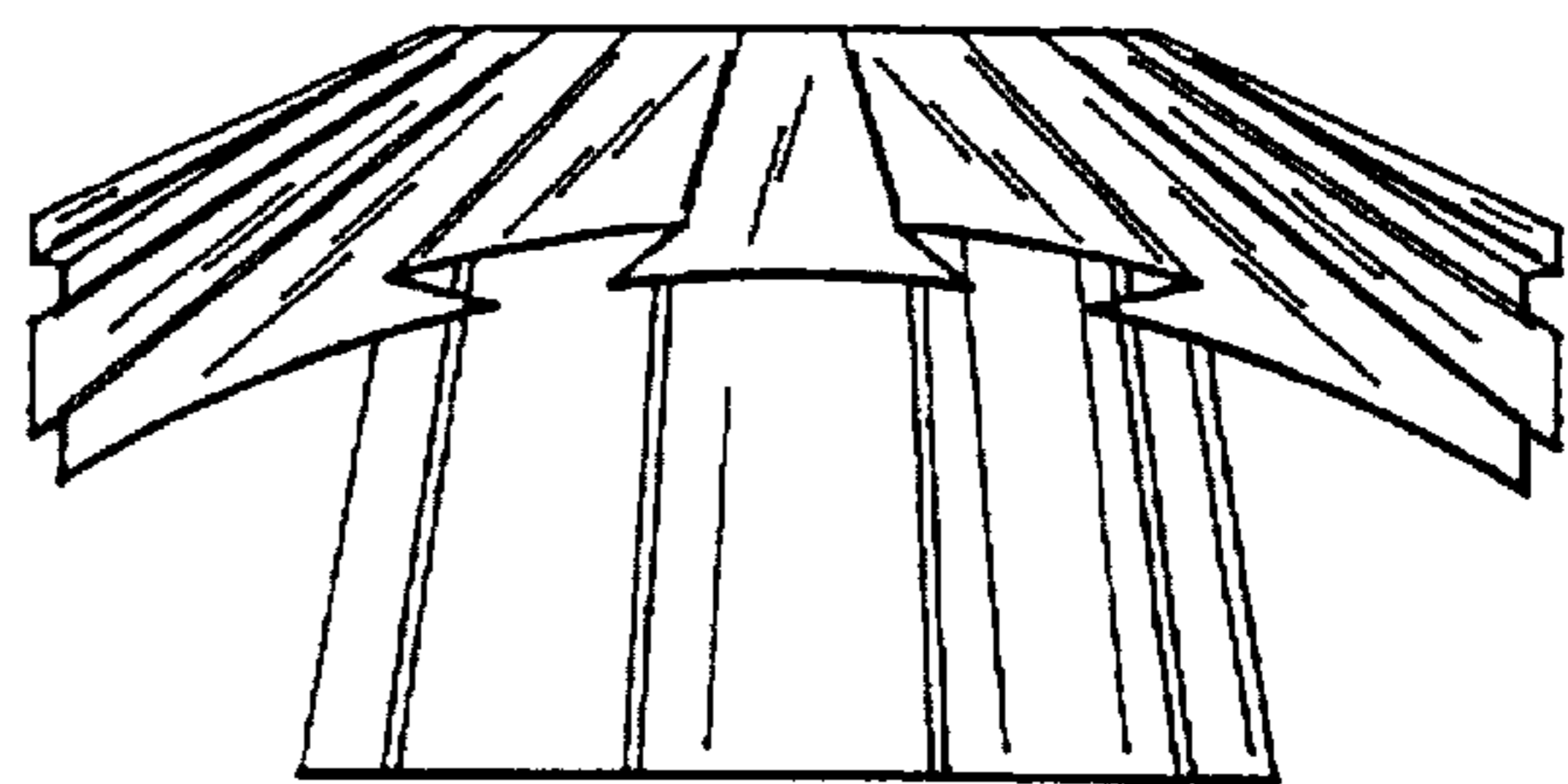

FIG. 28

UNITED STATES PATENT AND TRADEMARK OFFICE
CERTIFICATE OF CORRECTION

PATENT NO. : Des. 391,195
DATED : February 24, 1998
INVENTOR(S) : Donald E. Weder et al.

It is certified that error appears in the above-identified patent and that said Letters Patent is hereby corrected as shown below:

Cover Sheet, under DESCRIPTION, FIG. 6, after 'difference being in', please insert --the near vertical angle of--.

Signed and Sealed this
Twelfth Day of May, 1998



BRUCE LEHMAN

Commissioner of Patents and Trademarks

Attest:

Attesting Officer