



US00D391173S

**United States Patent** [19]  
**Wang**

[11] **Patent Number: Des. 391,173**  
[45] **Date of Patent: \*\*Feb. 24, 1998**

[54] **CASTLE CLOCK**

[76] **Inventor: I-Hwa Wang, P.O. Box 55-175,  
Taichung, Taiwan**

[\*\*] **Term: 14 Years**

[21] **Appl. No.: 60,573**

[22] **Filed: Oct. 1, 1996**

[51] **LOC (6) Cl. .... 10-01**

[52] **U.S. Cl. .... D10/7; D10/8; D10/11**

[58] **Field of Search .... D10/1-2, 6-8,  
D10/11, 122-132; 368/10, 276-277, 317-318,  
280; D21/165**

[56] **References Cited**

**U.S. PATENT DOCUMENTS**

D. 83,625 3/1931 Castro ..... D10/11  
D. 161,688 1/1951 Goldner ..... D10/8

D. 210,740 4/1968 Appel ..... D10/8  
D. 342,697 12/1993 Delson ..... D11/157  
D. 354,401 1/1995 Kim ..... D10/12 X  
D. 361,939 9/1995 Wang ..... D10/7

*Primary Examiner*—Nelson C. Holtje

[57] **CLAIM**

The ornamental design for a castle clock, as shown.

**DESCRIPTION**

FIG. 1 is a perspective view to show my new design of castle clock;

FIG. 2 is a front view of FIG. 1;

FIG. 3 is a left side view of FIG. 1;

FIG. 4 is a right side view of FIG. 1;

FIG. 5 is a top view of FIG. 1;

FIG. 6 is a bottom view of FIG. 1; and,

FIG. 7 is a rear side view of FIG. 1.

**1 Claim, 6 Drawing Sheets**

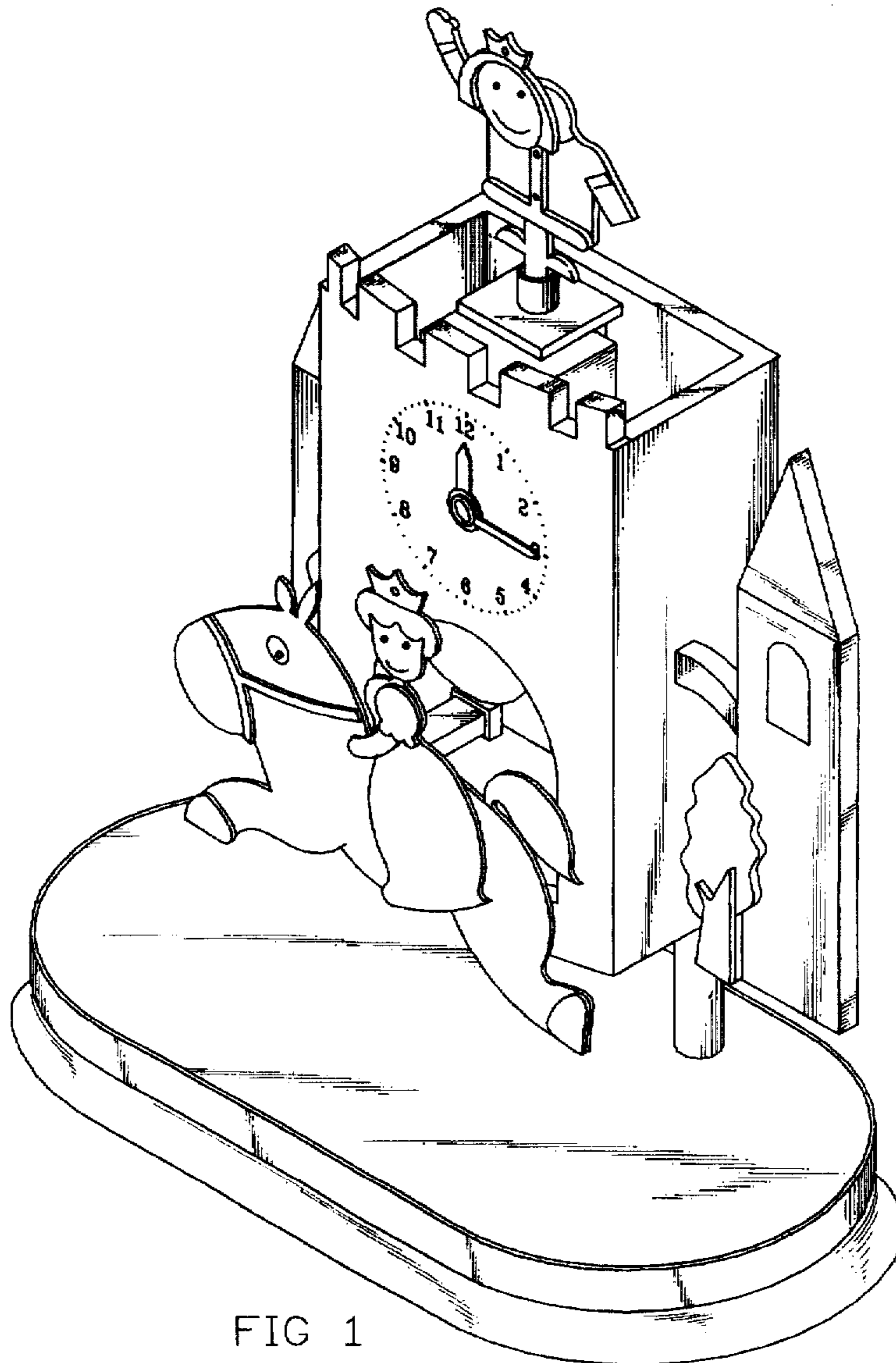

FIG 1

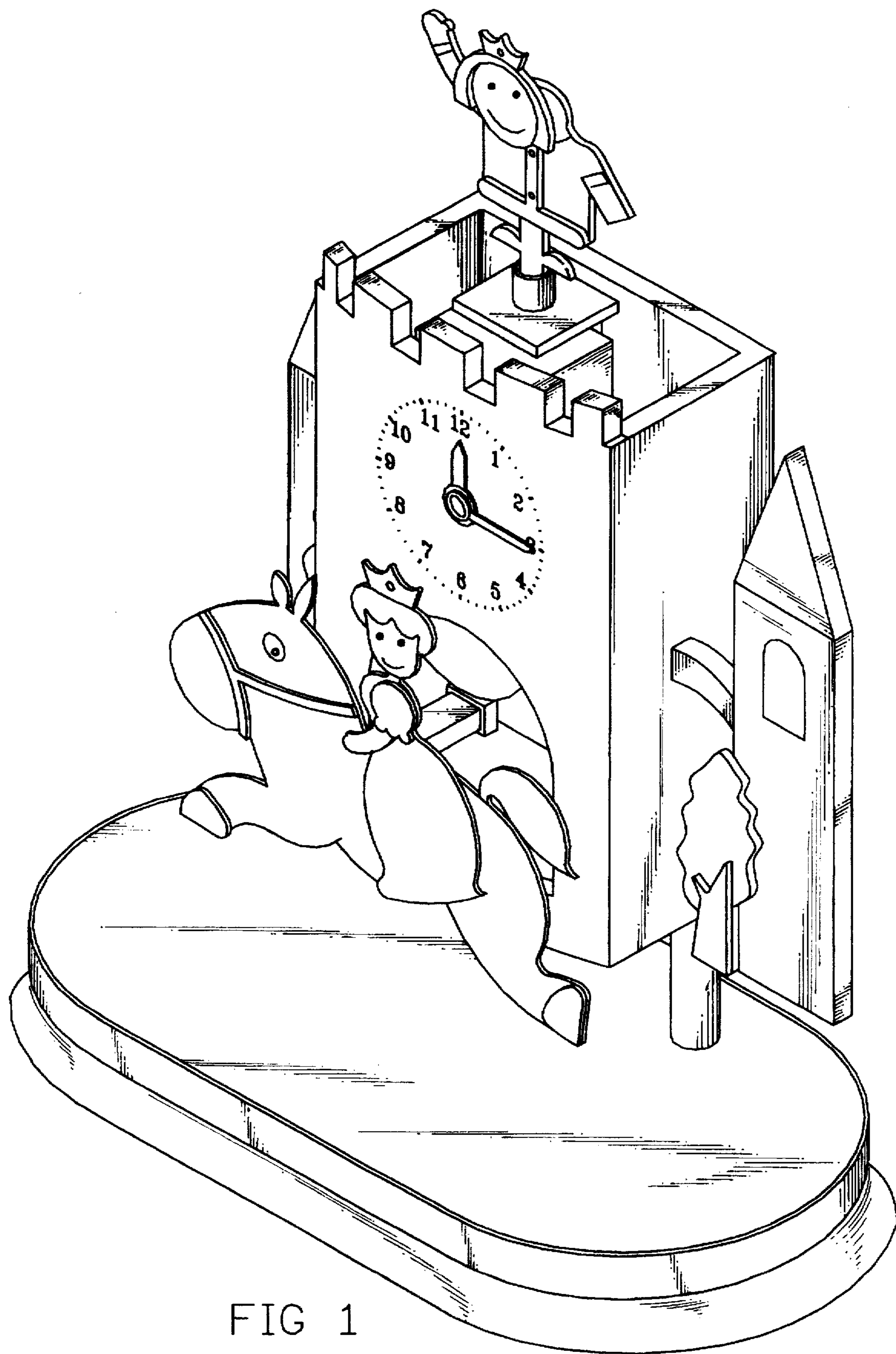

FIG 1

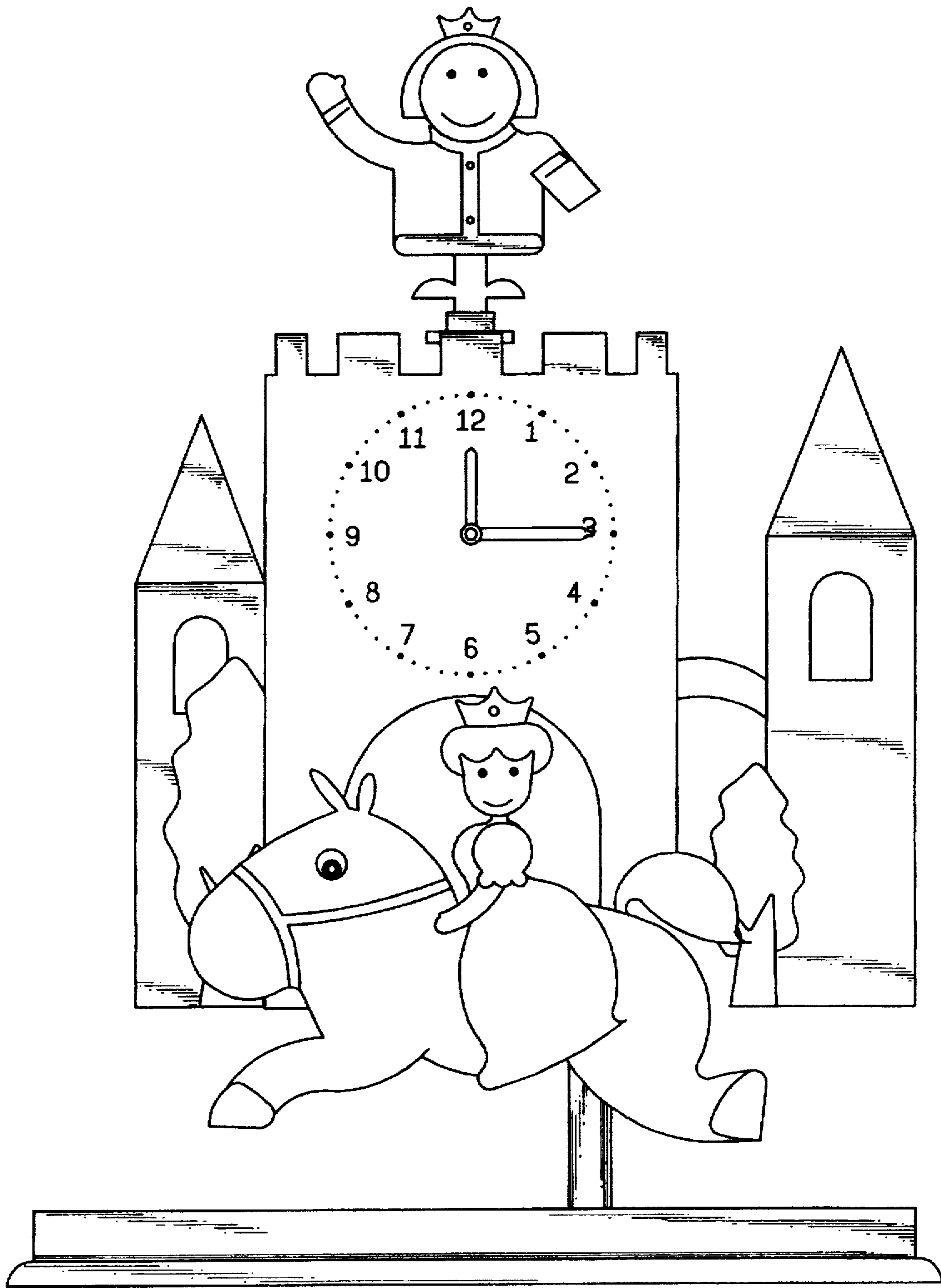

FIG 2

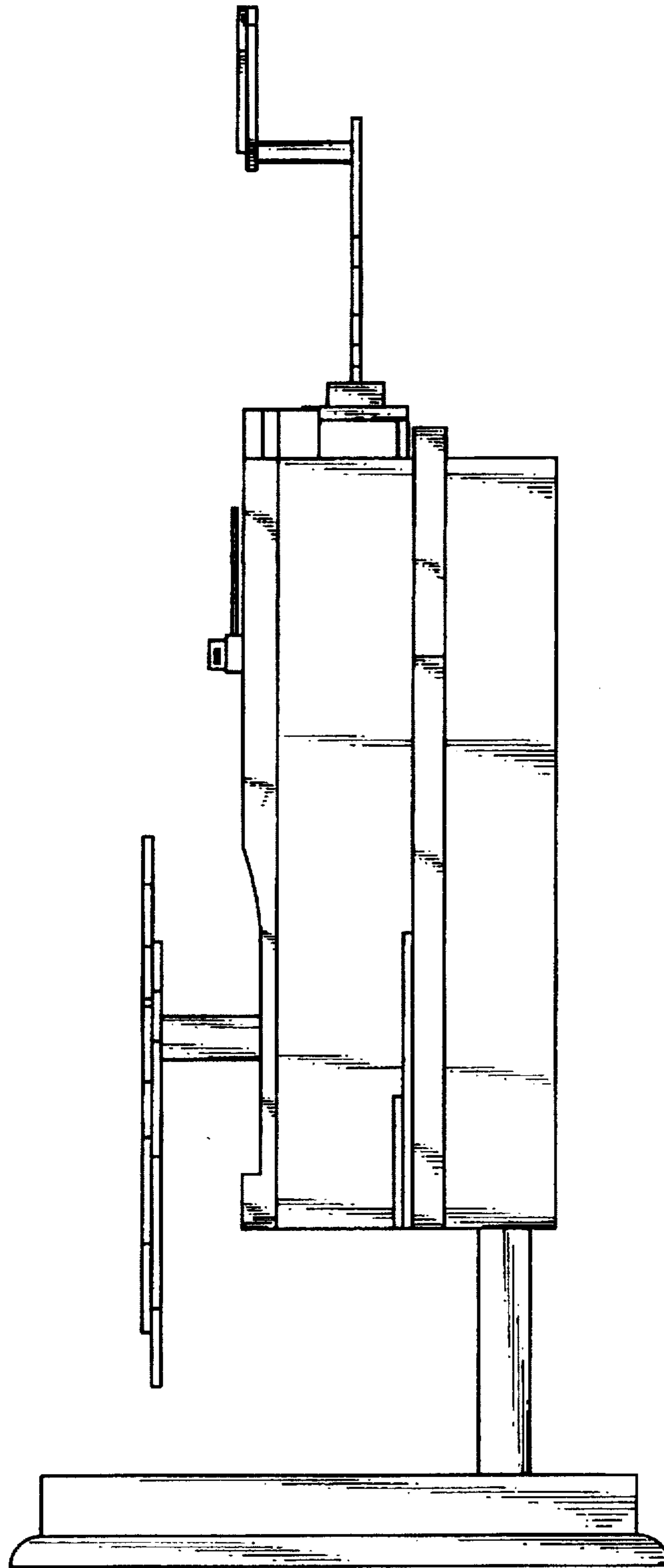

FIG 3

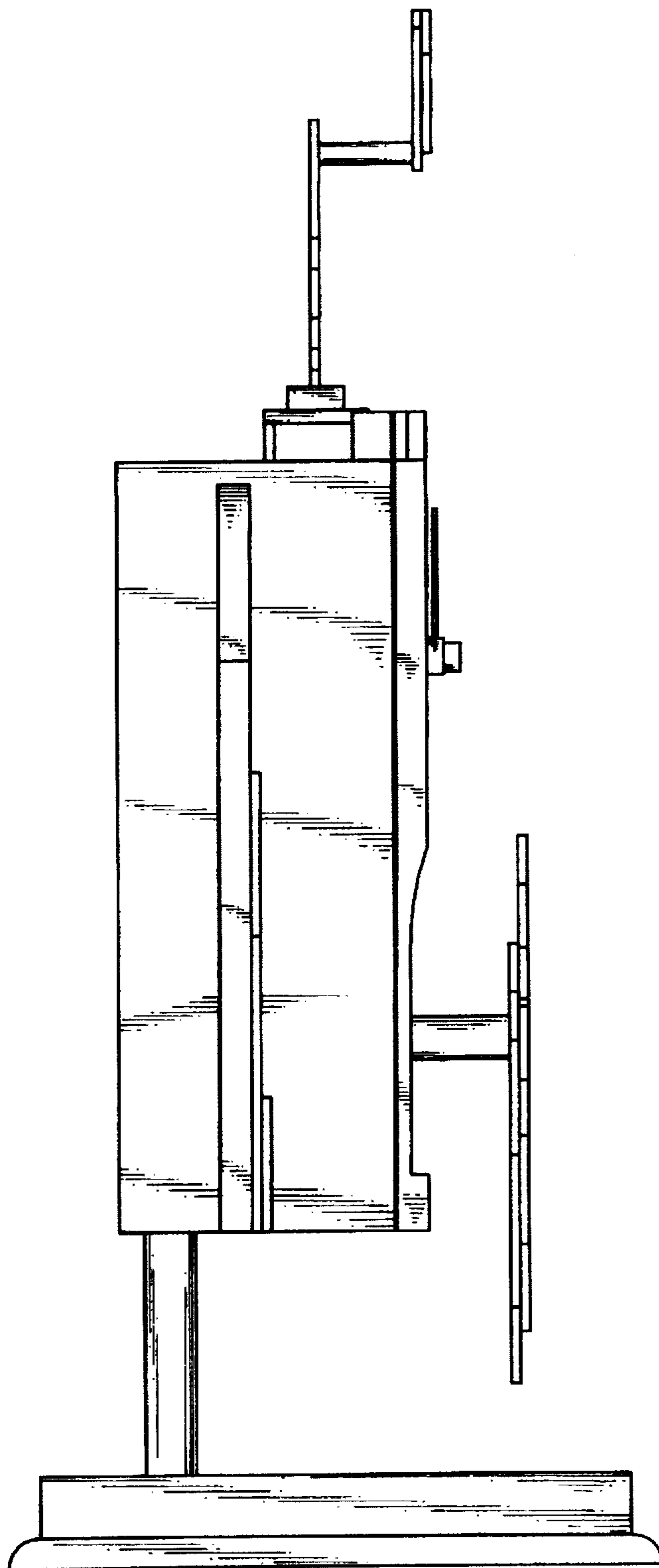

FIG 4



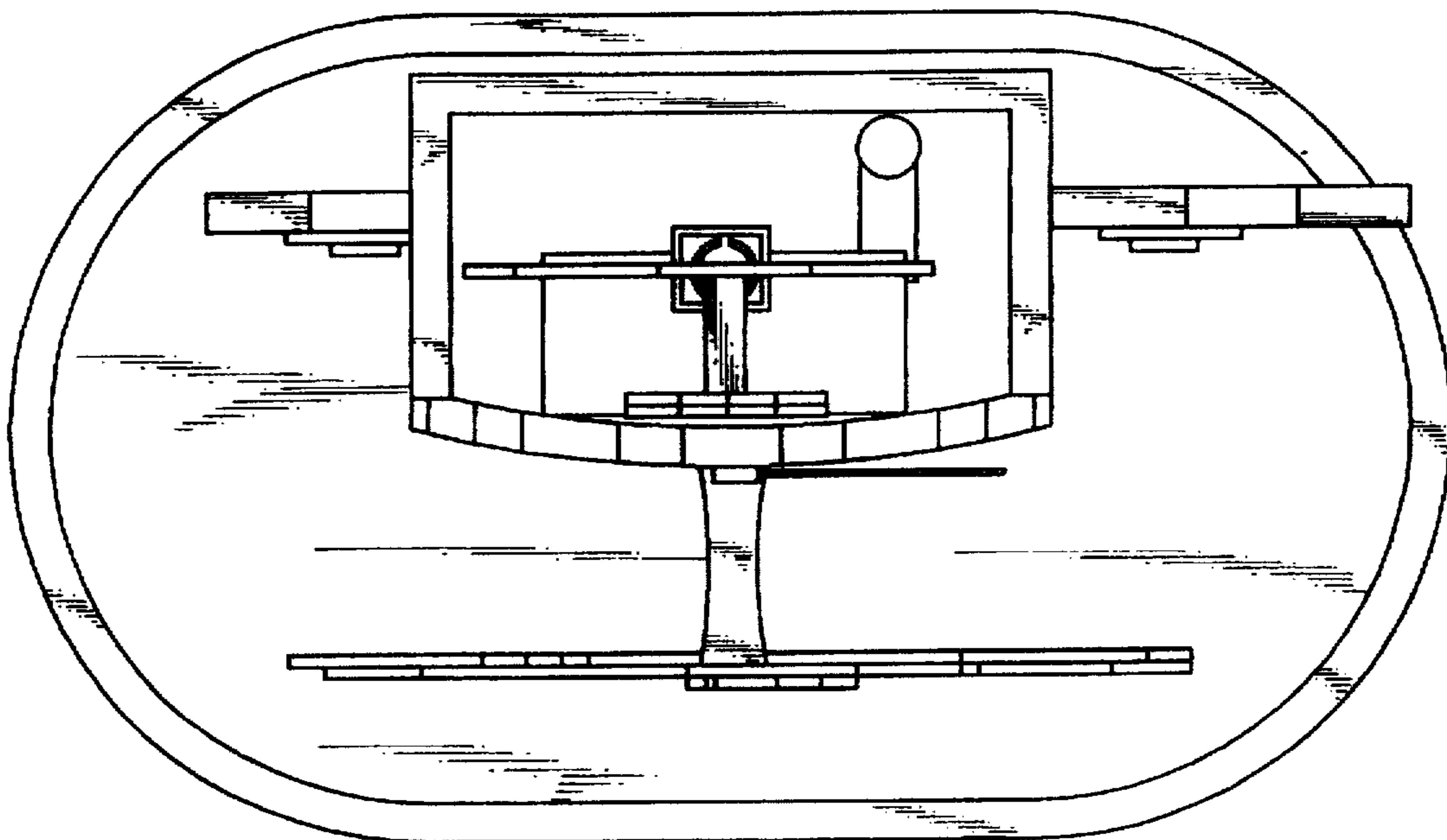

FIG 5

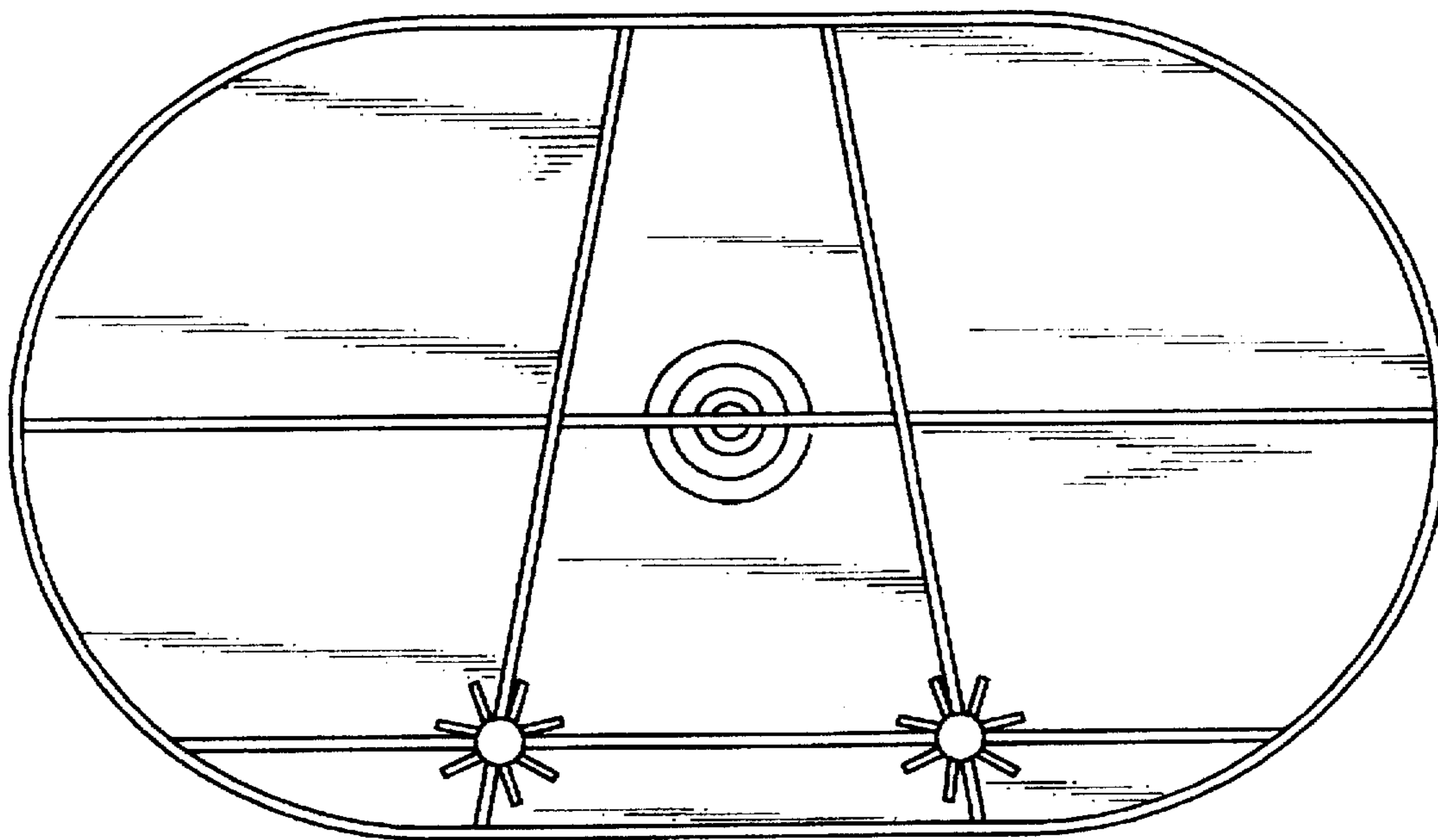

FIG 6

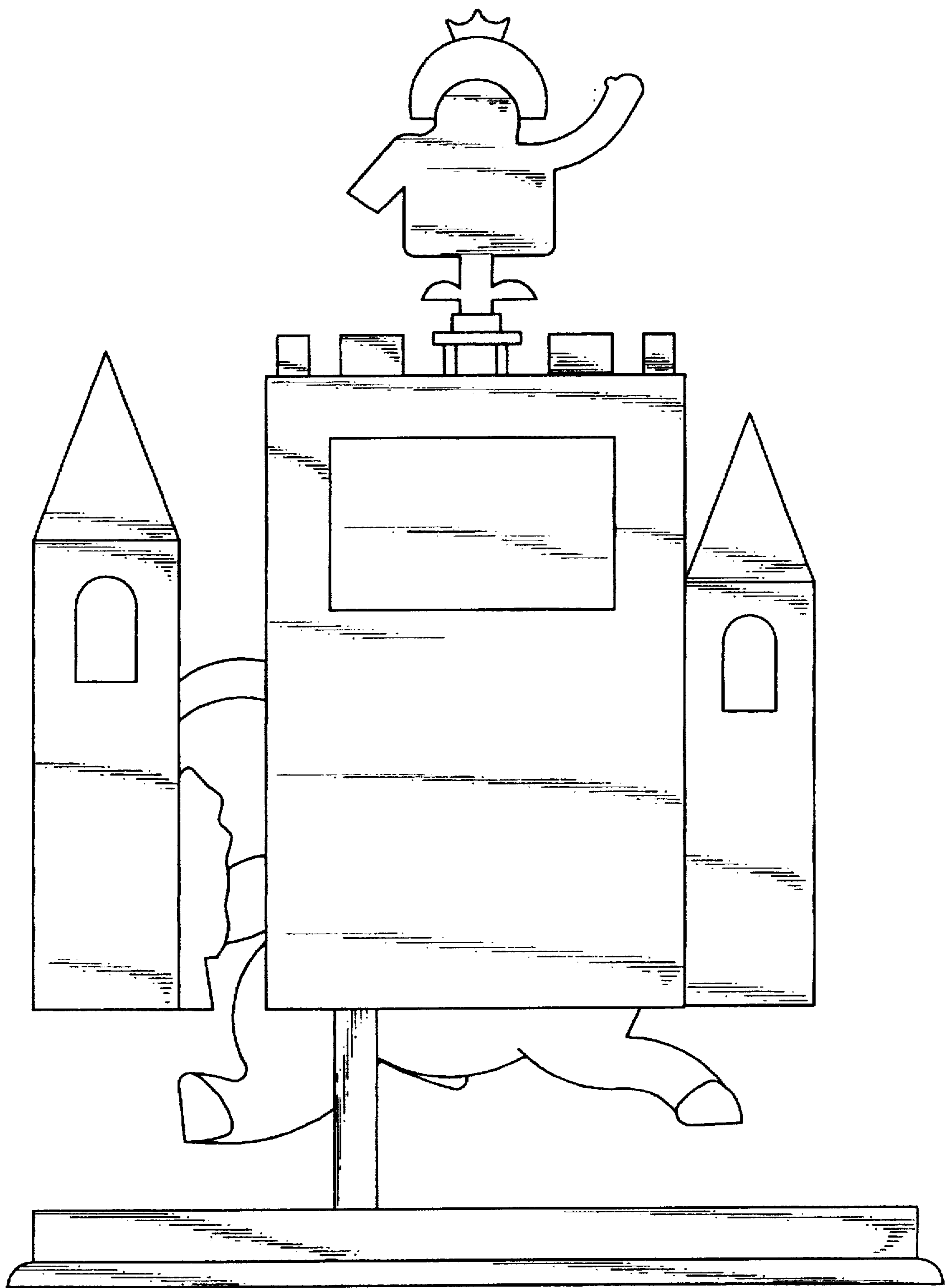

FIG 7