



US00D391149S

United States Patent [19]

Gonzales

[11] Patent Number: **Des. 391,149**

[45] Date of Patent: ****Feb. 24, 1998**

[54] **DRYWALL AND/OR GYPSUM BOARD WALL REPAIR CLIP**

2,325,766 8/1943 Gisondi 52/361
4,178,730 12/1979 Rowinski 52/514

[76] Inventor: **Stephen John Gonzales**, 15 Deer Creek La., Laguna Hills, Calif. 92653

Primary Examiner—B. J. Bullock

[**] Term: **14 Years**

[57] CLAIM

[21] Appl. No.: **59,753**

The ornamental design for a drywall and/or gypsum board wall repair clip, as shown and described.

[22] Filed: **Sep. 16, 1996**

DESCRIPTION

[51] LOC (6) Cl. **08-08**

FIG. 1 is a rear elevational view of the drywall and/or gypsum board wall repair clip showing my new design;
FIG. 2 is a front elevational view thereof;
FIG. 3 is a right side elevational view thereof;
FIG. 4 is a left side elevational view thereof;
FIG. 5 is a top plan view thereof;
FIG. 6 is a bottom plan view thereof; and,
FIG. 7 is an isometric view thereof.

[52] U.S. Cl. **D8/388**

[58] Field of Search 88/382, 388; 52/361-363, 52/514

[56] References Cited

U.S. PATENT DOCUMENTS

1,277,514 9/1918 Widmer 52/361
2,216,019 9/1940 Morgan 52/362

1 Claim, 4 Drawing Sheets

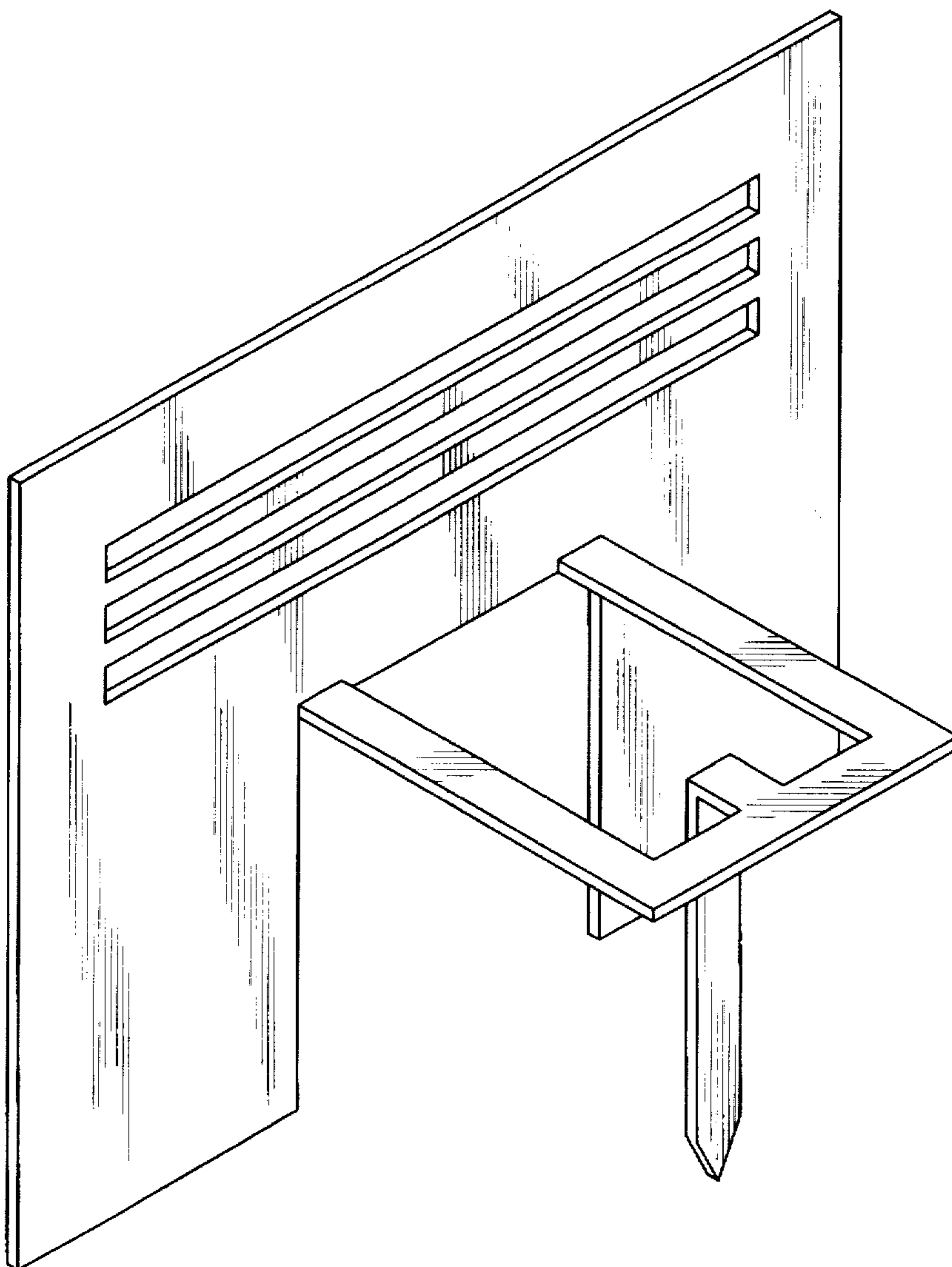

FIG. 1

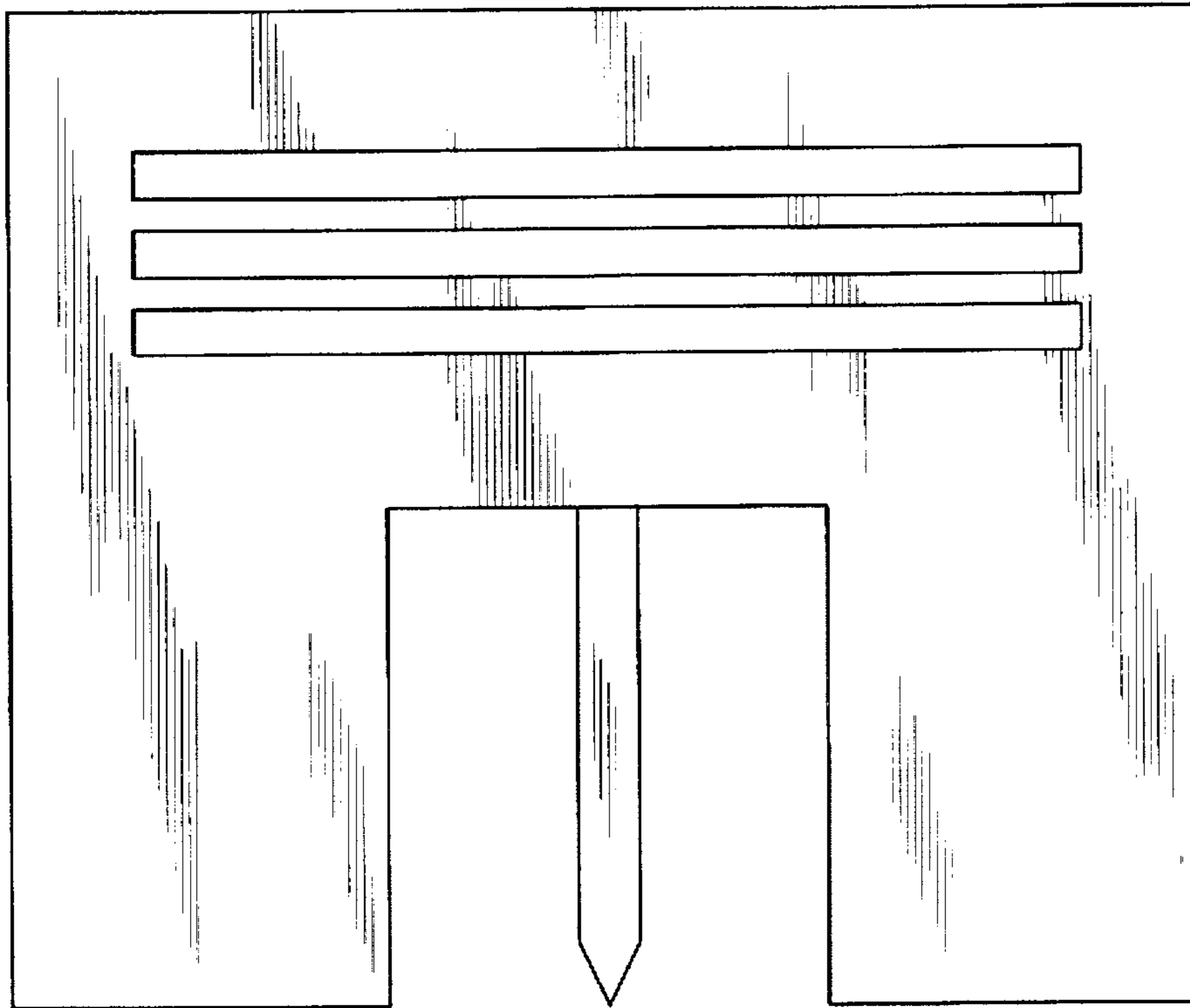

FIG. 2

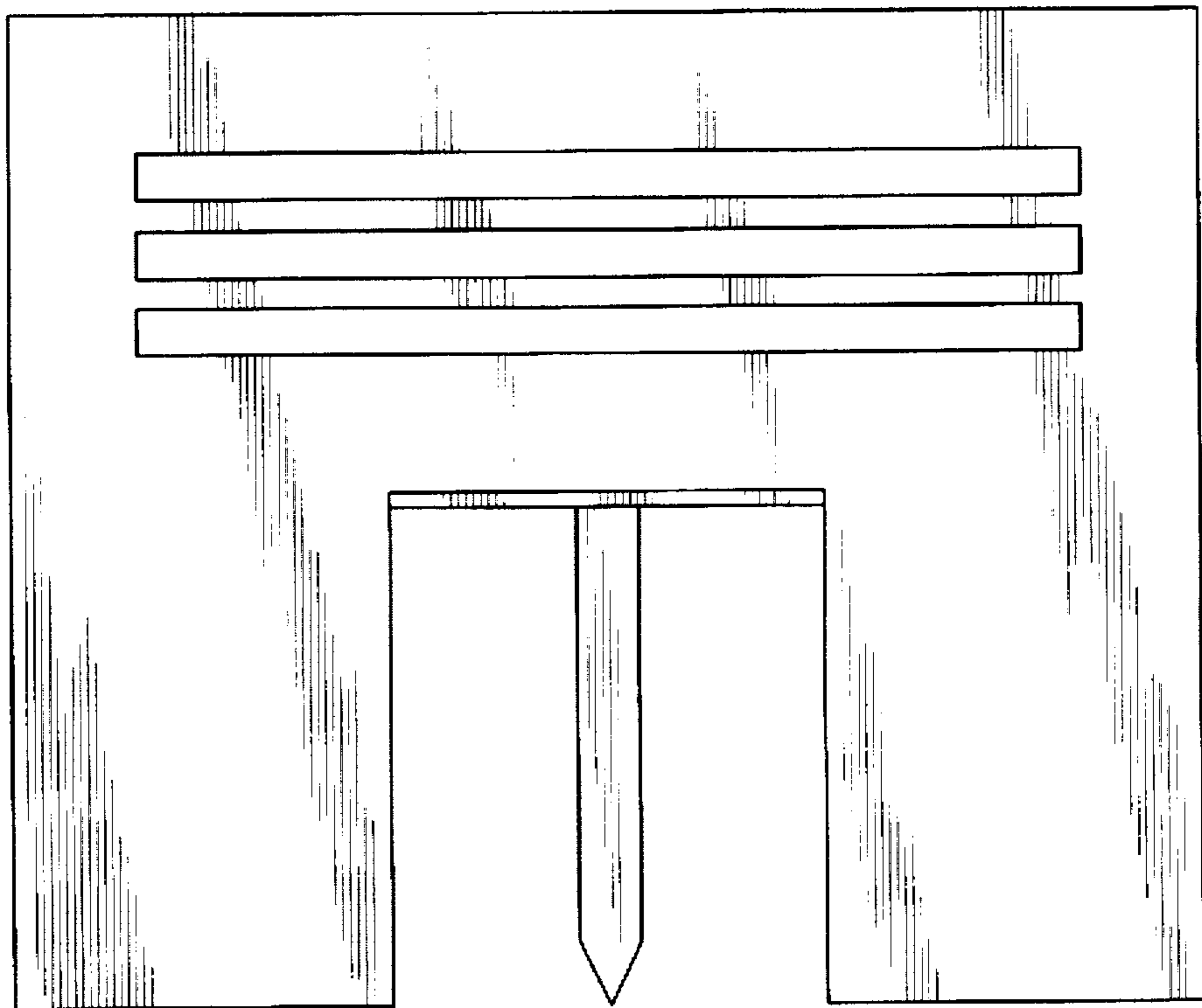

FIG. 3

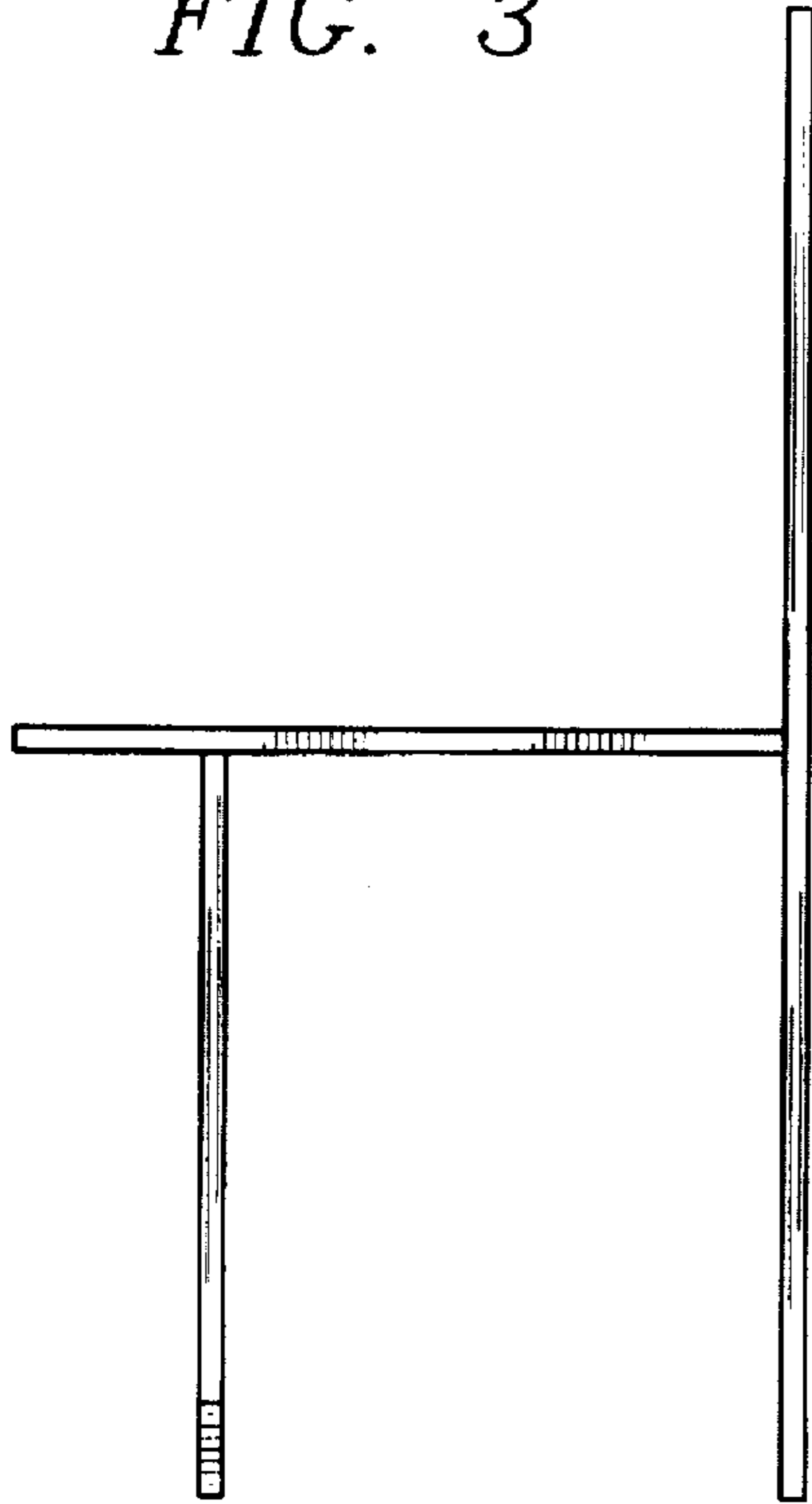

FIG. 4

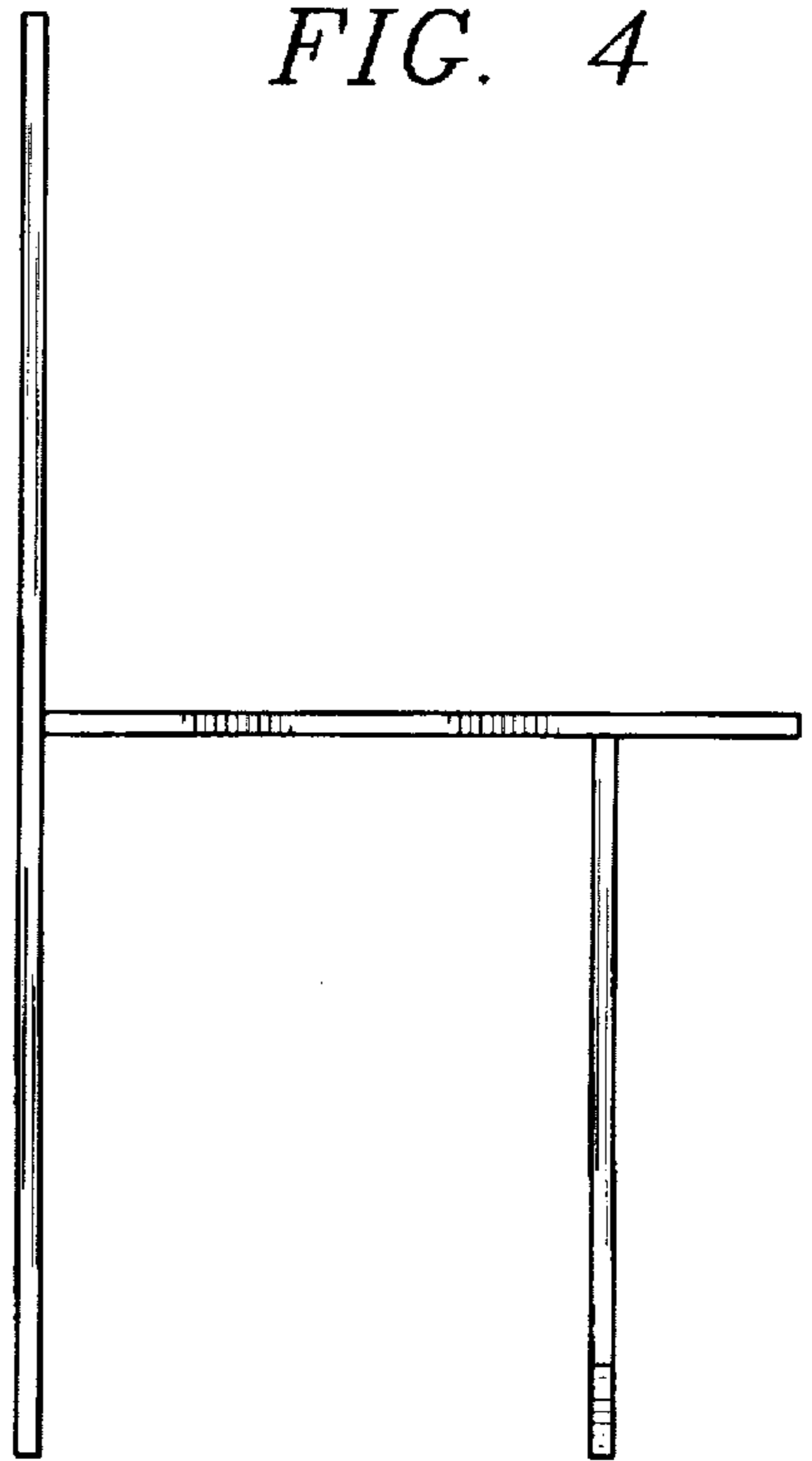

FIG. 5

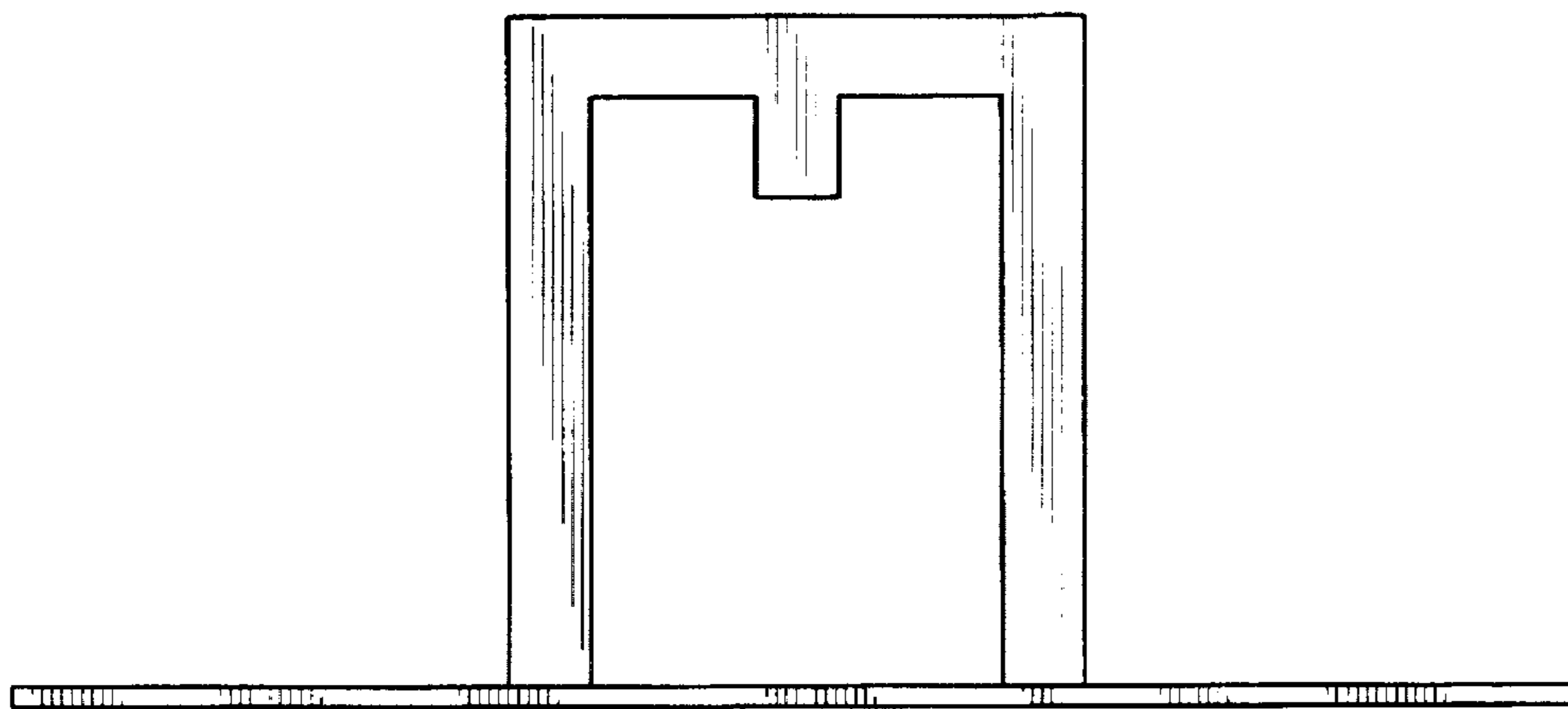

FIG. 6

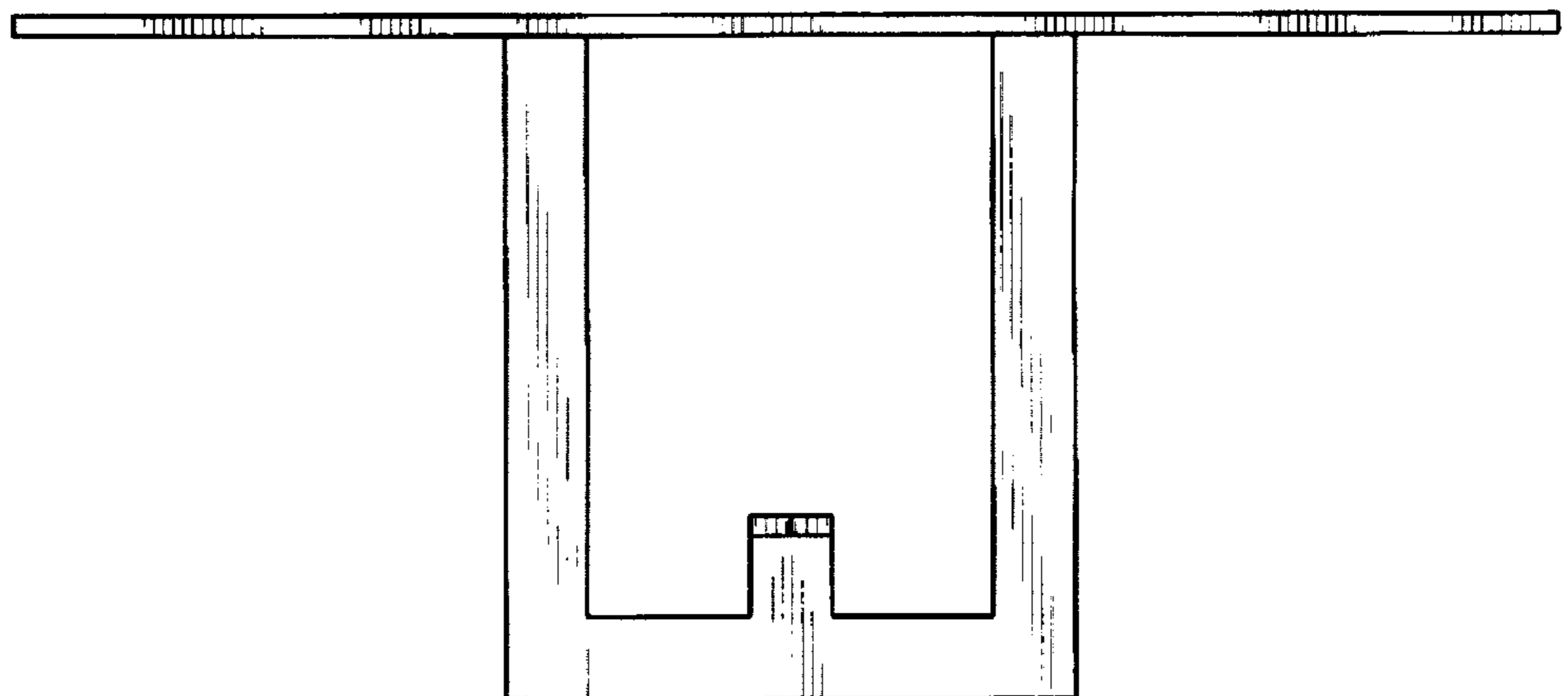

FIG. 7

