



US00D391109S

United States Patent [19]
Miller

[11] **Patent Number: Des. 391,109**
[45] **Date of Patent: **Feb. 24, 1998**

[54] **BEACH MAT**

[76] **Inventor: Catherine Miller, 1 Kroll Ter., Secaucus, N.J. 07094**

[**] **Term: 14 Years**

[21] **Appl. No.: 66,814**

[22] **Filed: Feb. 21, 1997**

[51] **LOC (6) Cl. 06-09**

[52] **U.S. Cl. D6/596; D6/601; D6/608**

[58] **Field of Search D6/595-597, 601, D6/605, 392; 5/630, 632, 633, 417-420, 652, 653, 656**

[56] **References Cited**

U.S. PATENT DOCUMENTS

D. 318,772	8/1991	Phillips	D6/595
4,188,988	2/1980	Agyagos	5/417 X
4,970,741	11/1990	Spina	5/417
5,361,435	11/1994	Reeves	5/419
5,435,025	7/1995	Gerard et al.	5/417

Primary Examiner—Janice E. Seeger
Attorney, Agent, or Firm—Lawrence G. Fridman

[57] **CLAIM**

The ornamental design for a beach mat, as shown and described.

DESCRIPTION

FIG. 1 is a front elevational view of the beach mat according to my new design in a rolled-up condition;
FIG. 2 is a right-hand side elevational view thereof; a left-hand side view is similar to the view of FIG. 2;
FIG. 3 is a top plan view thereof;
FIG. 4 is a bottom plan view thereof;
FIG. 5 is a rear elevational view thereof;
FIG. 6 is a top, left-corner perspective view of the beach mat of my invention in an unrolled condition;
FIG. 7 is a rear elevational view thereof; and,
FIG. 8 is a bottom, right-corner perspective view of the beach mat in the unrolled position.

1 Claim, 4 Drawing Sheets

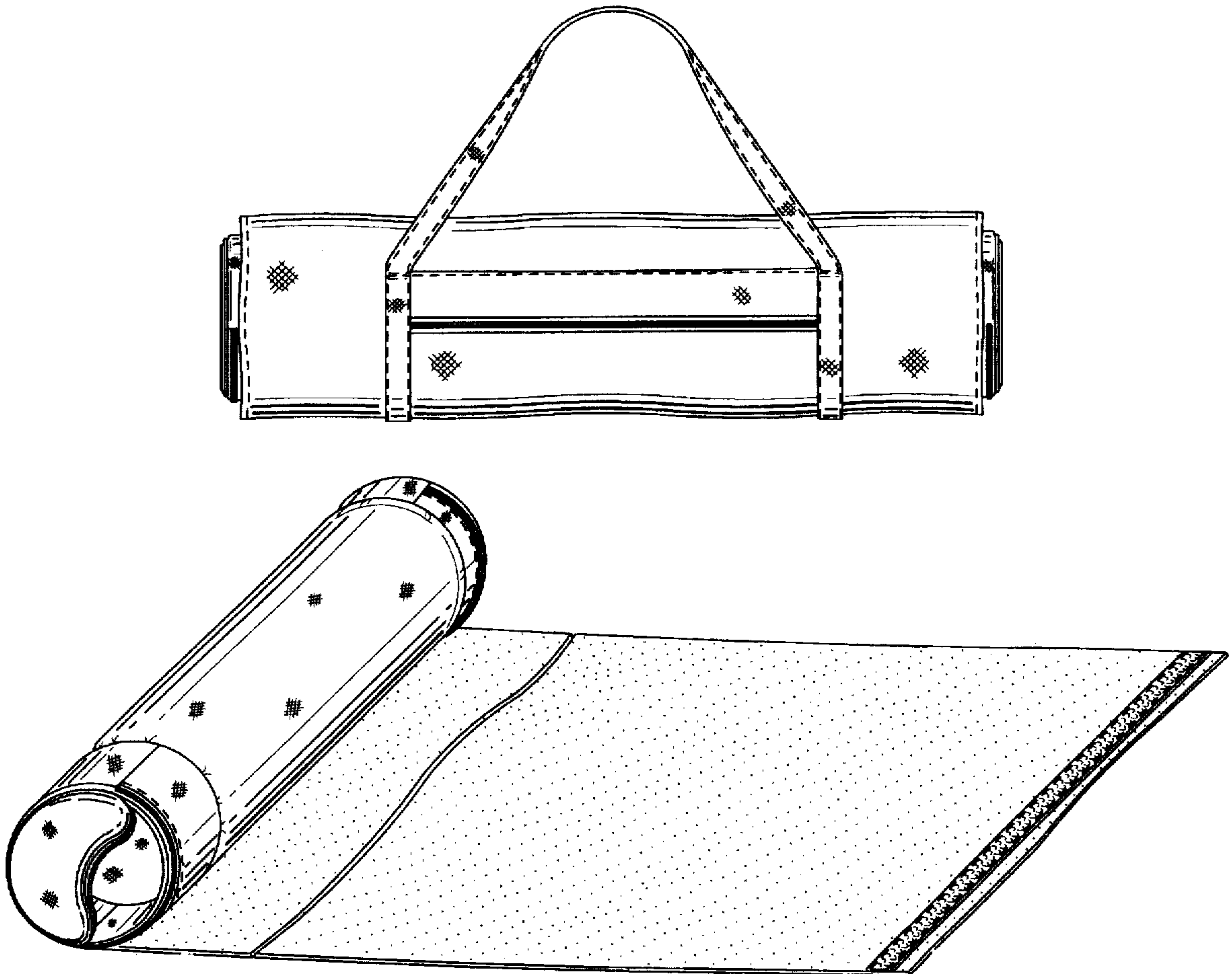

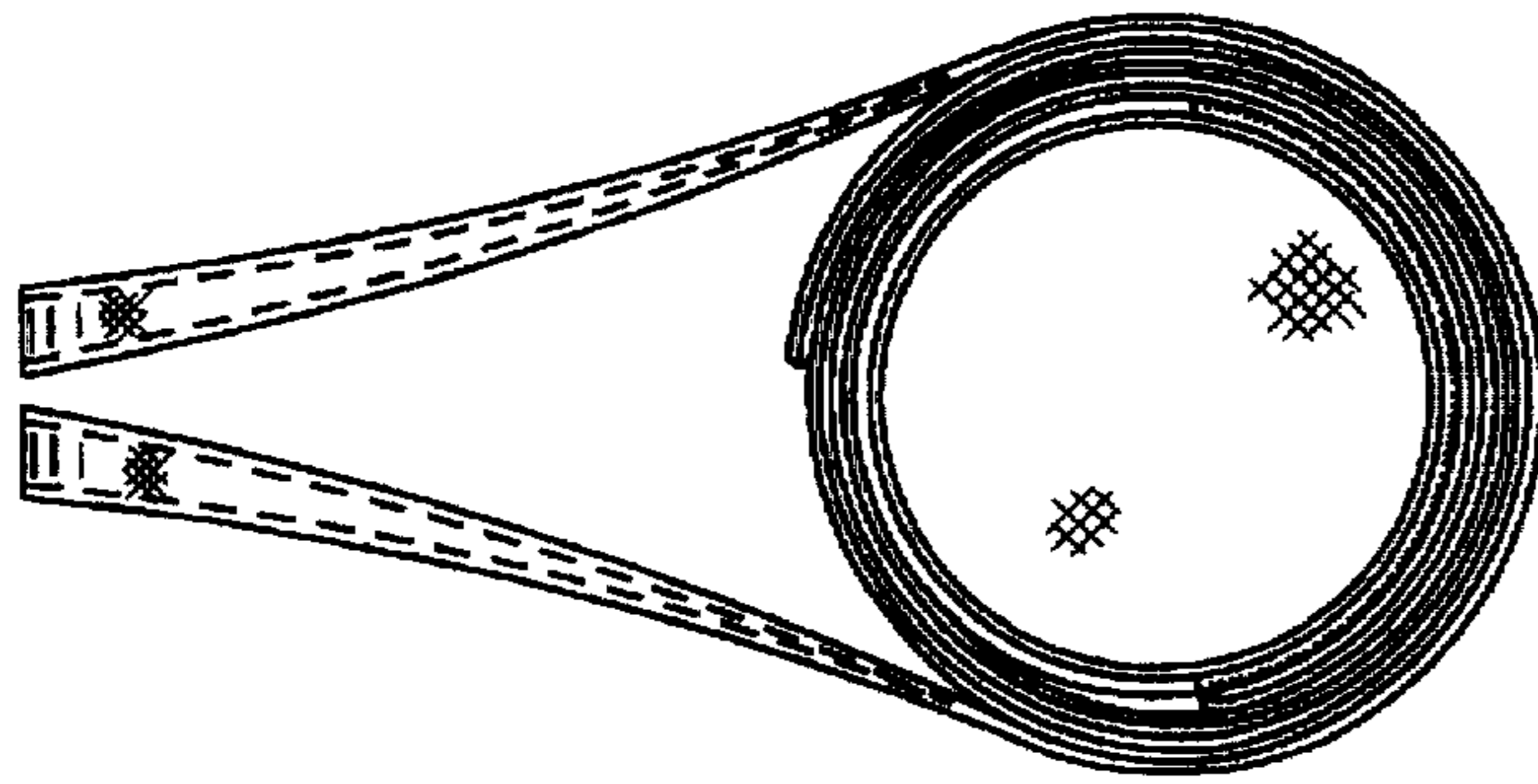

FIG. 2

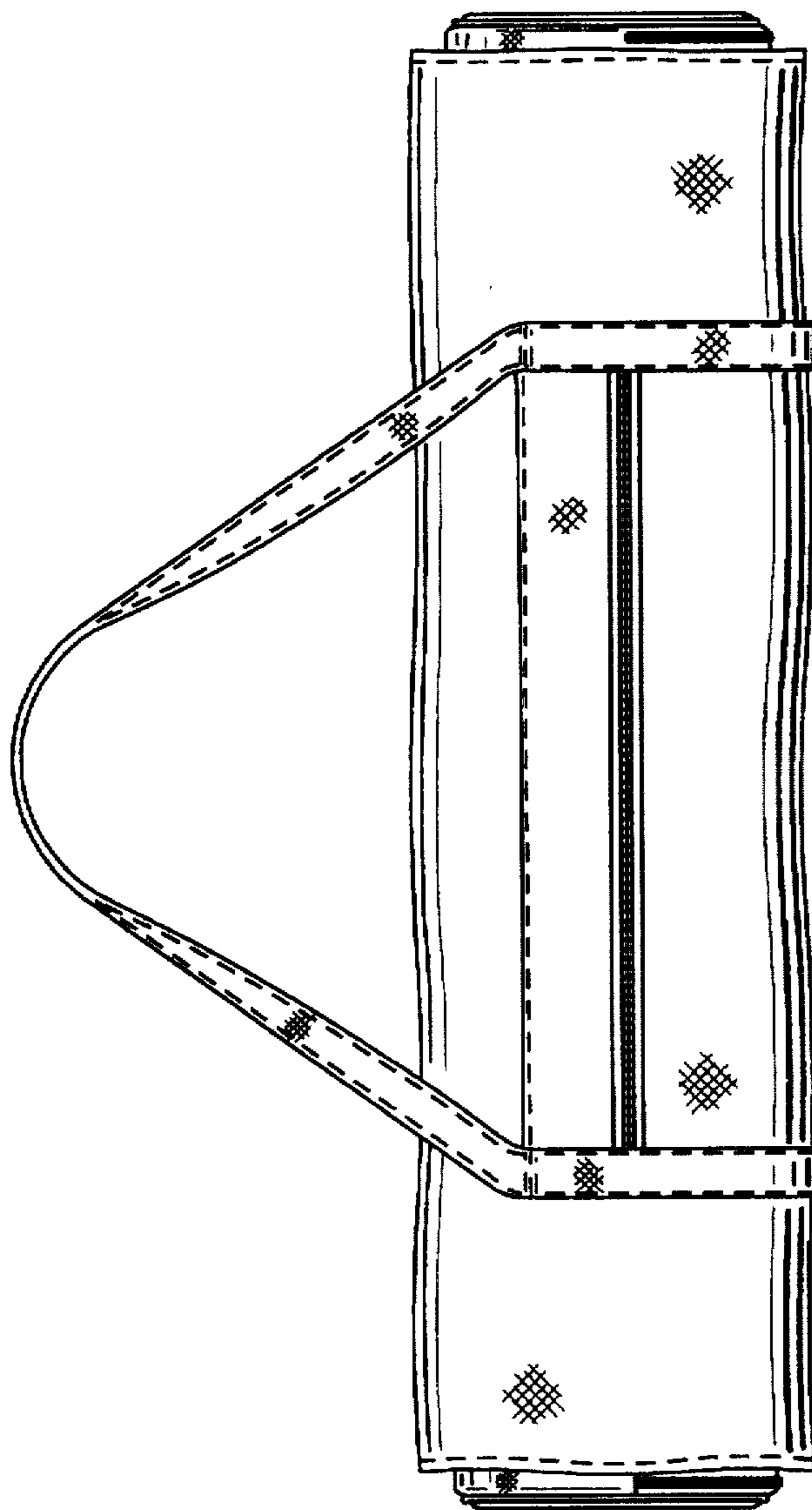

FIG. 1

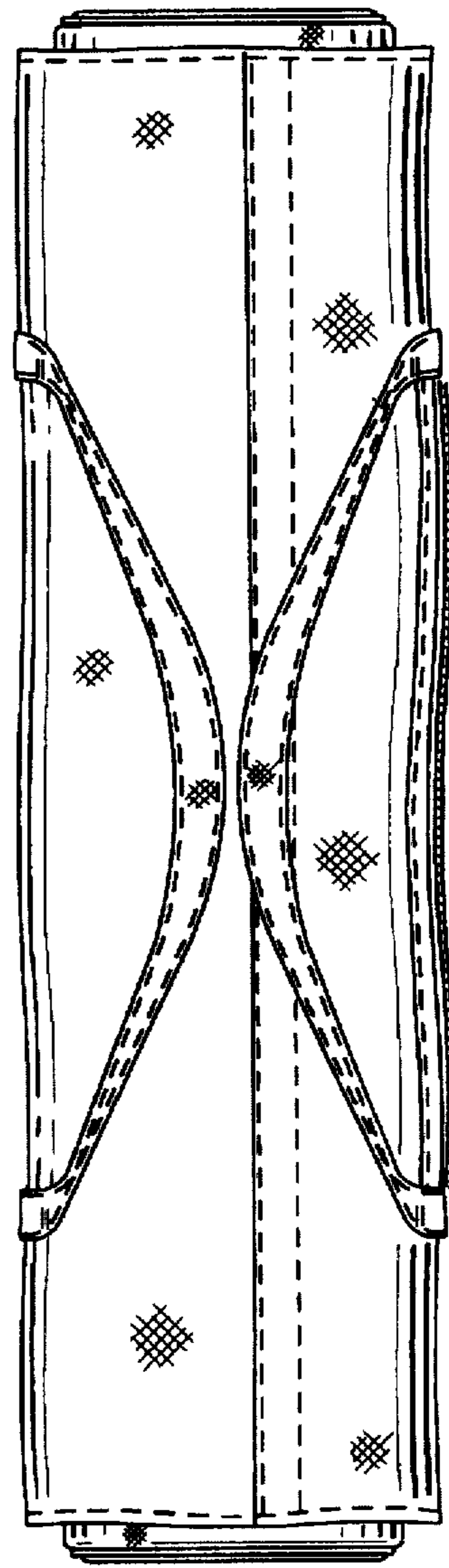

FIG. 3

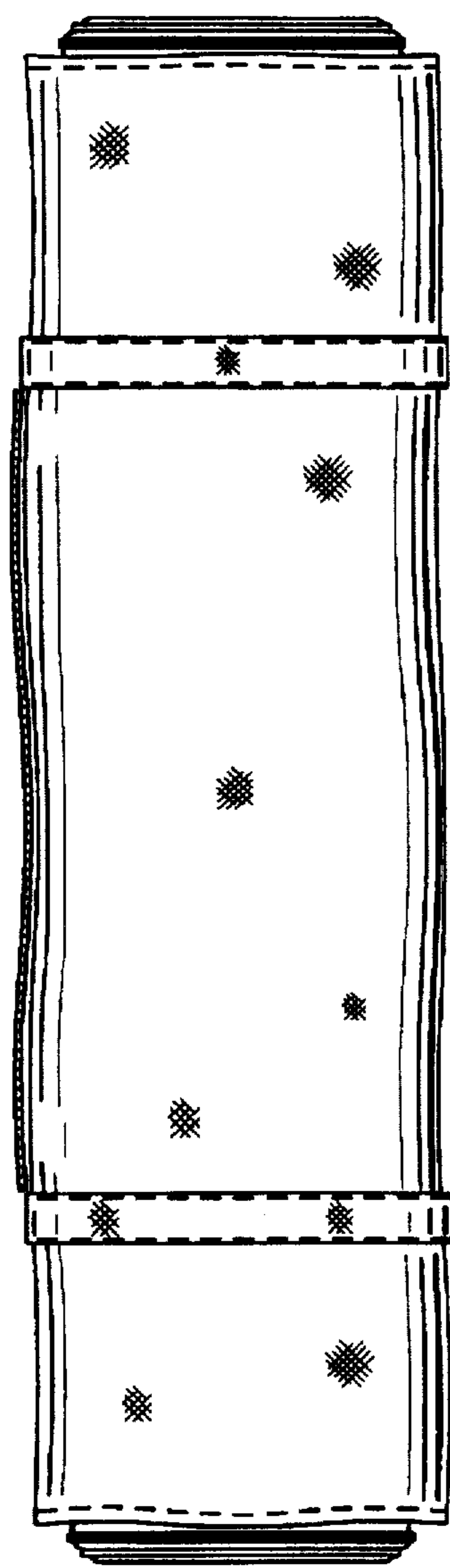

FIG. 4

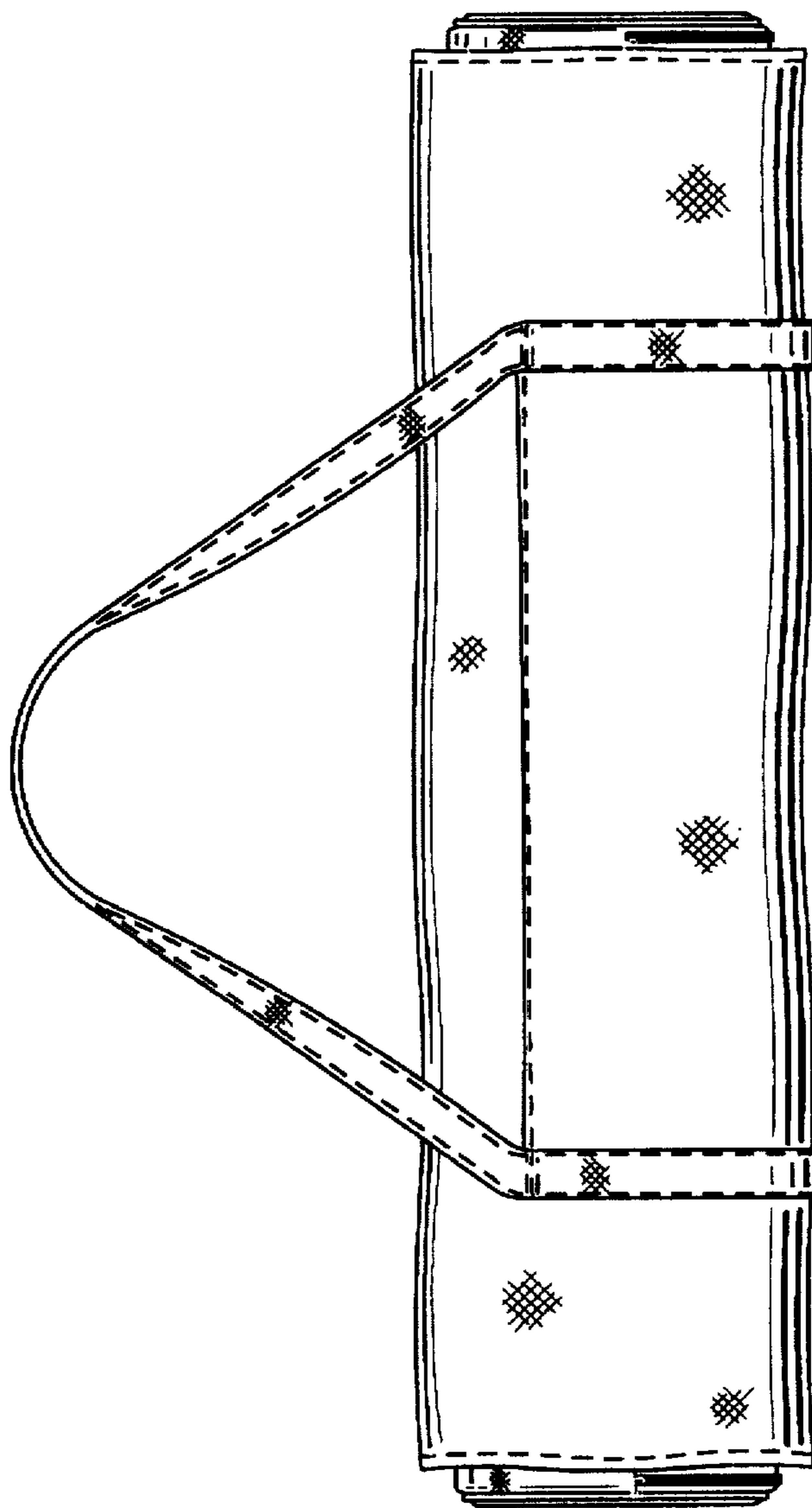

FIG. 5

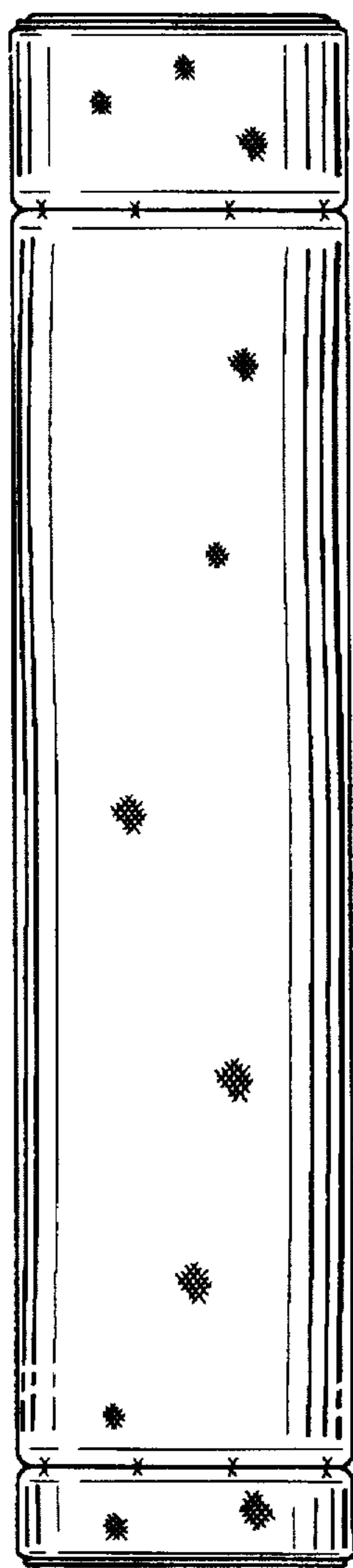

FIG. 7

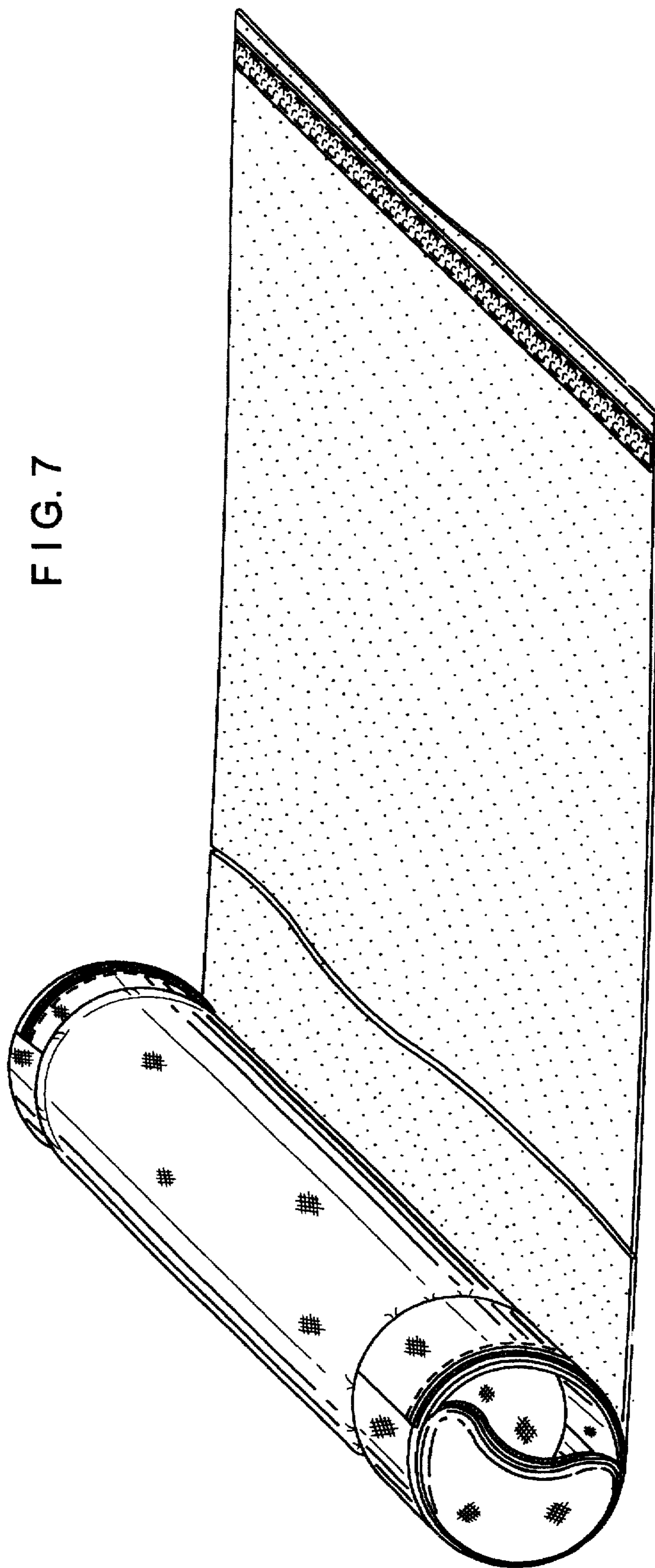

FIG. 6

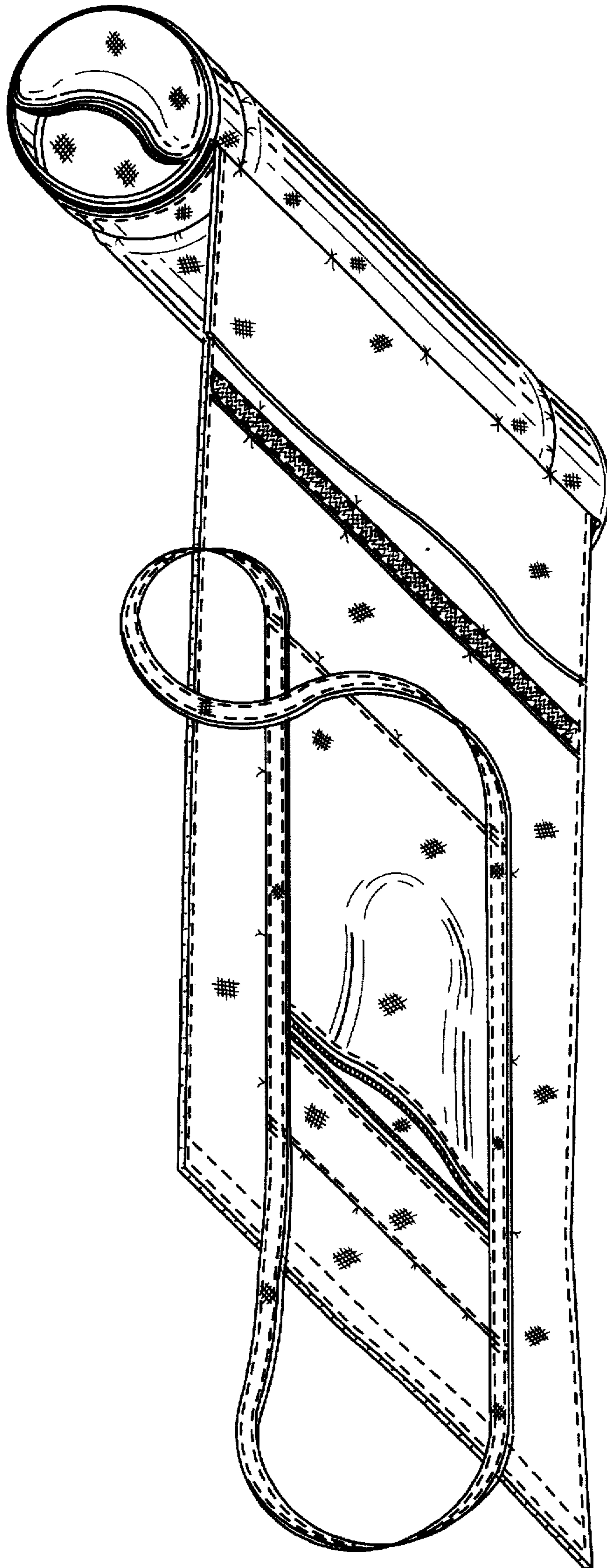

FIG. 8