



US00D391097S

United States Patent [19]

[11] Patent Number: **Des. 391,097**

Eichert et al.

[45] Date of Patent: ****Feb. 24, 1998**

[54] **DISPLAY STAND**

3,196,061 7/1965 Paulson et al. 108/150 X
4,792,470 12/1988 Clark 108/161 X

[75] Inventors: **Lance Eichert**, Conshohocken, Pa.;
Joseph Zucconi, Marlton, N.J.

Primary Examiner—James Gandy

Assistant Examiner—Linda Brooks

[73] Assignee: **Mars, Incorporated**, McLean, Va.

Attorney, Agent, or Firm—Fitzpatrick, Cella, Harper & Scinto

[**] Term: **14 Years**

[57] **CLAIM**

[21] Appl. No.: **60,373**

The ornamental display for a display stand, as shown and described.

[22] Filed: **Sep. 27, 1996**

DESCRIPTION

[51] **LOC (6) Cl.** **06-04**

[52] **U.S. Cl.** **D6/449; D6/455**

[58] **Field of Search** D6/449, 455, 495,
D6/473, 486, 498; D9/430, 431, 418; D19/59,
62; D21/108; D18/10; 52/DIG. 10; 434/211,
278; 108/161, 150; D11/131, 142; 229/108,
162; D25/6, 7

FIG. 1 is a top perspective view of a display stand in accordance with the present invention;

FIG. 2 is a side view of the display stand of FIG. 1, the opposite side view being a mirror image;

FIG. 3 is another side view, from a different angle, of the display stand of FIG. 1, the opposite side view being a mirror image;

FIG. 4 is a top view;

FIG. 5 is a bottom view; and,

FIG. 6 is a bottom perspective view of the display stand of FIG. 1.

[56] **References Cited**

U.S. PATENT DOCUMENTS

- D. 270,042 8/1983 Fisher D9/430
- D. 272,130 1/1984 Miyazaki D9/431
- D. 362,619 9/1995 Haas D9/418

1 Claim, 4 Drawing Sheets

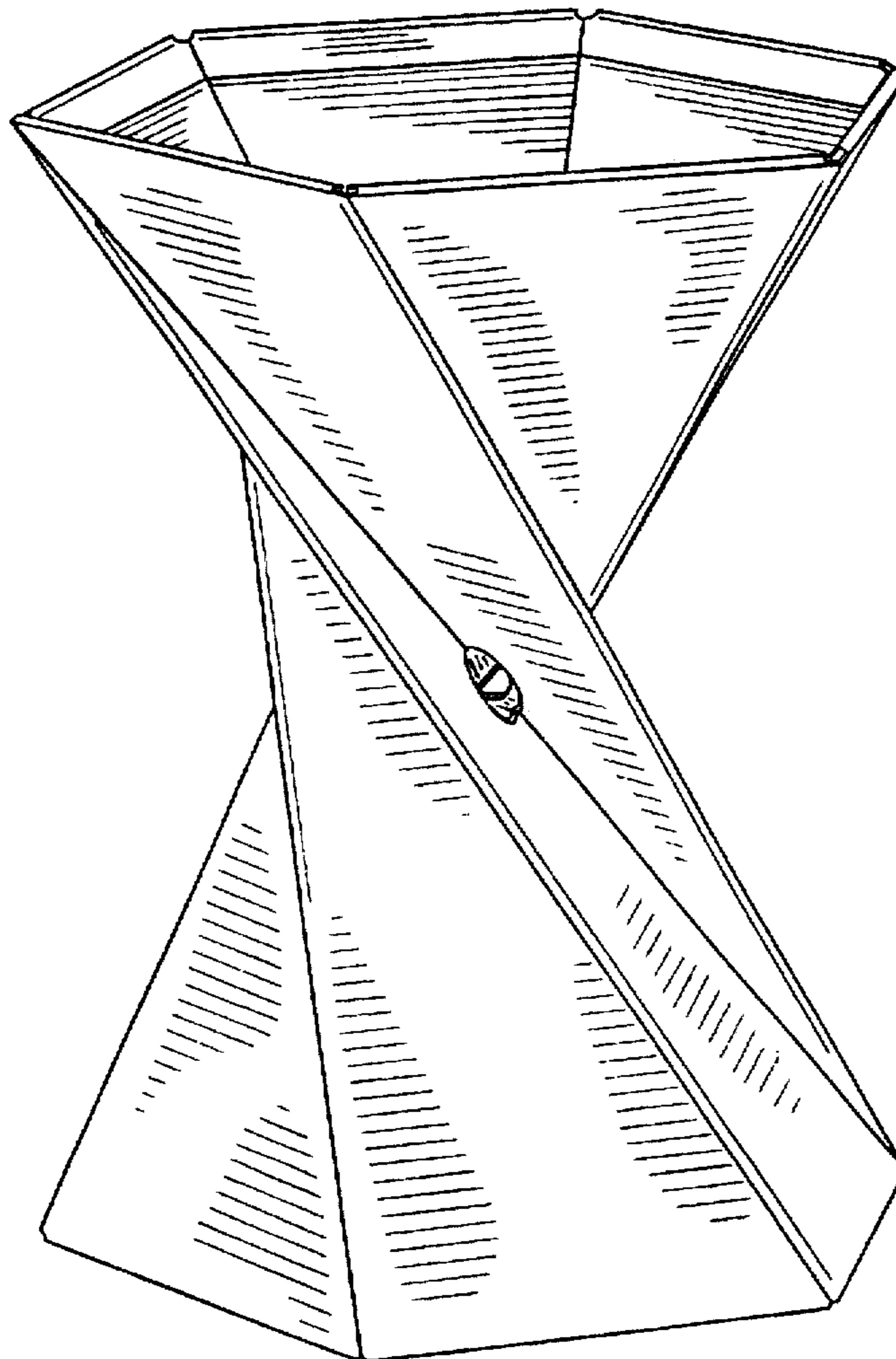

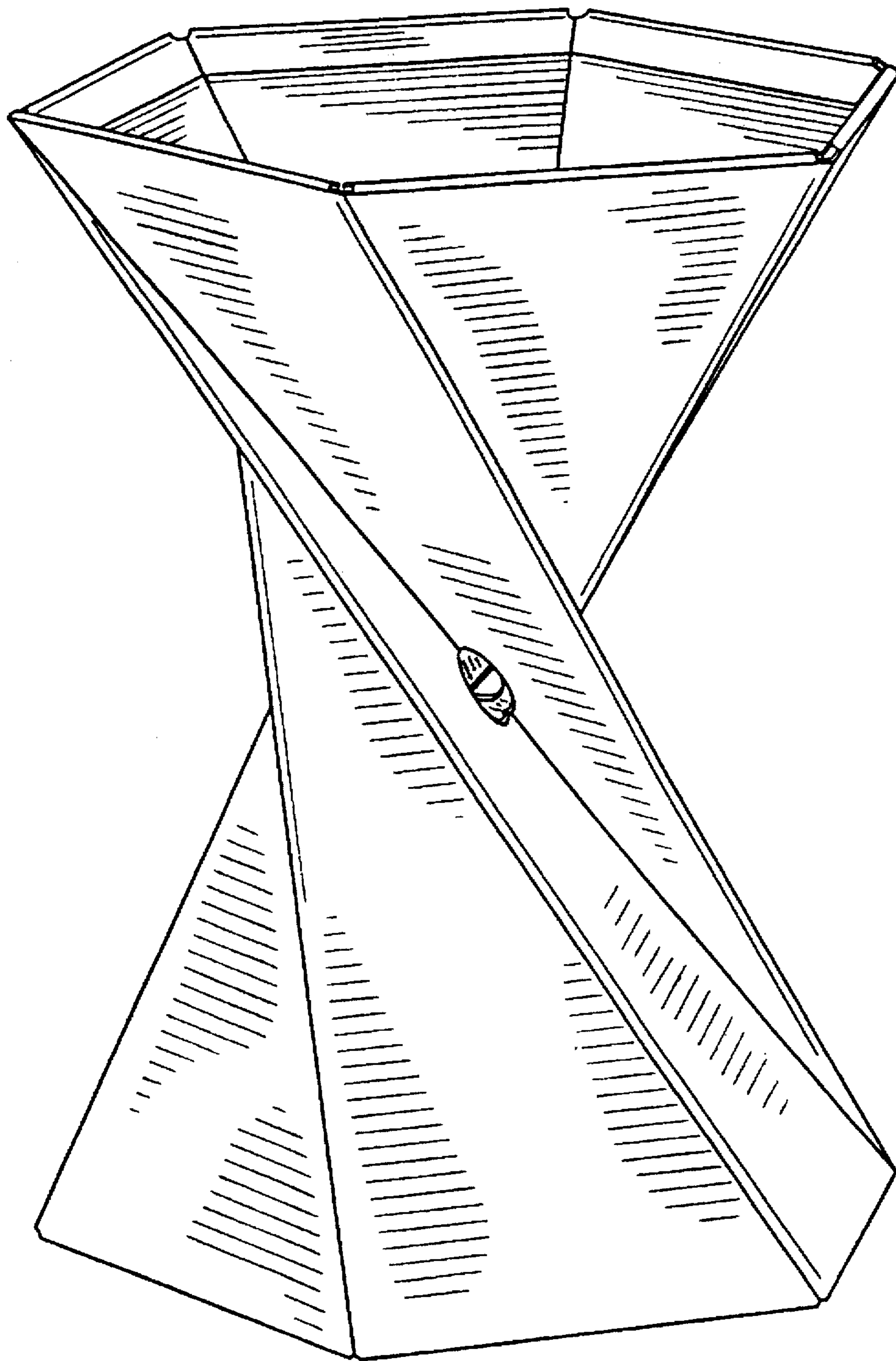

FIG. 1

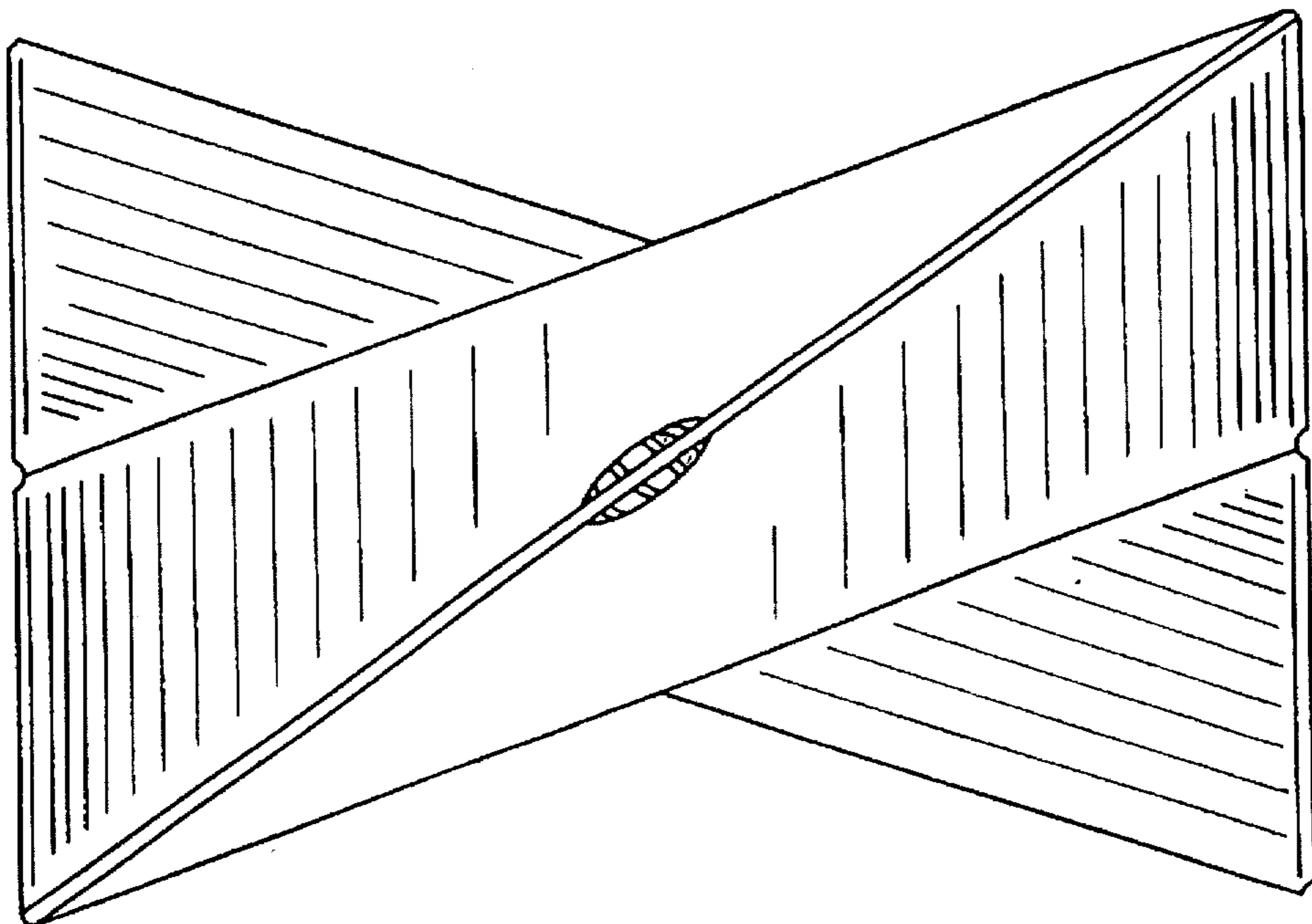

FIG. 3

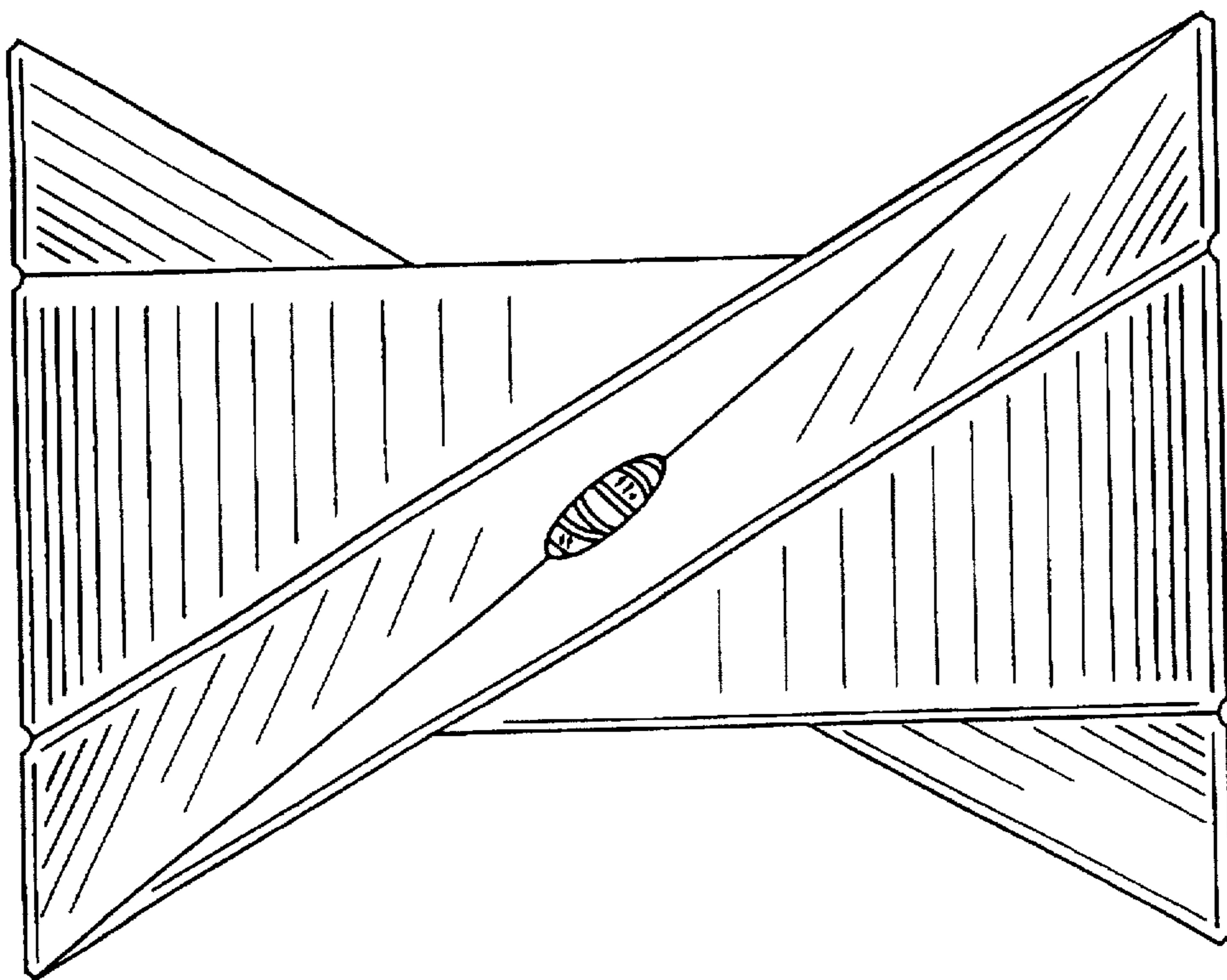

FIG. 2

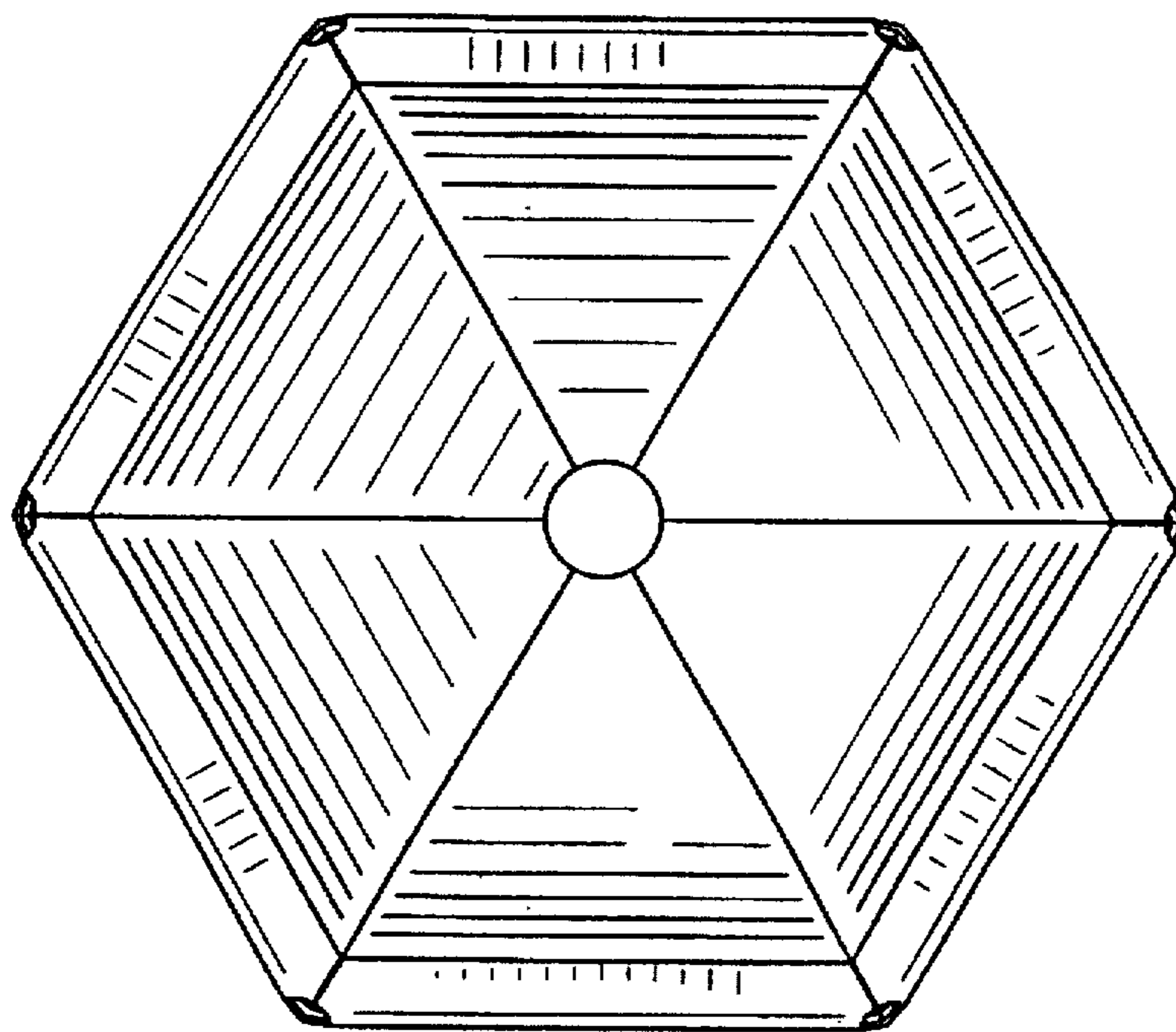

FIG. 4

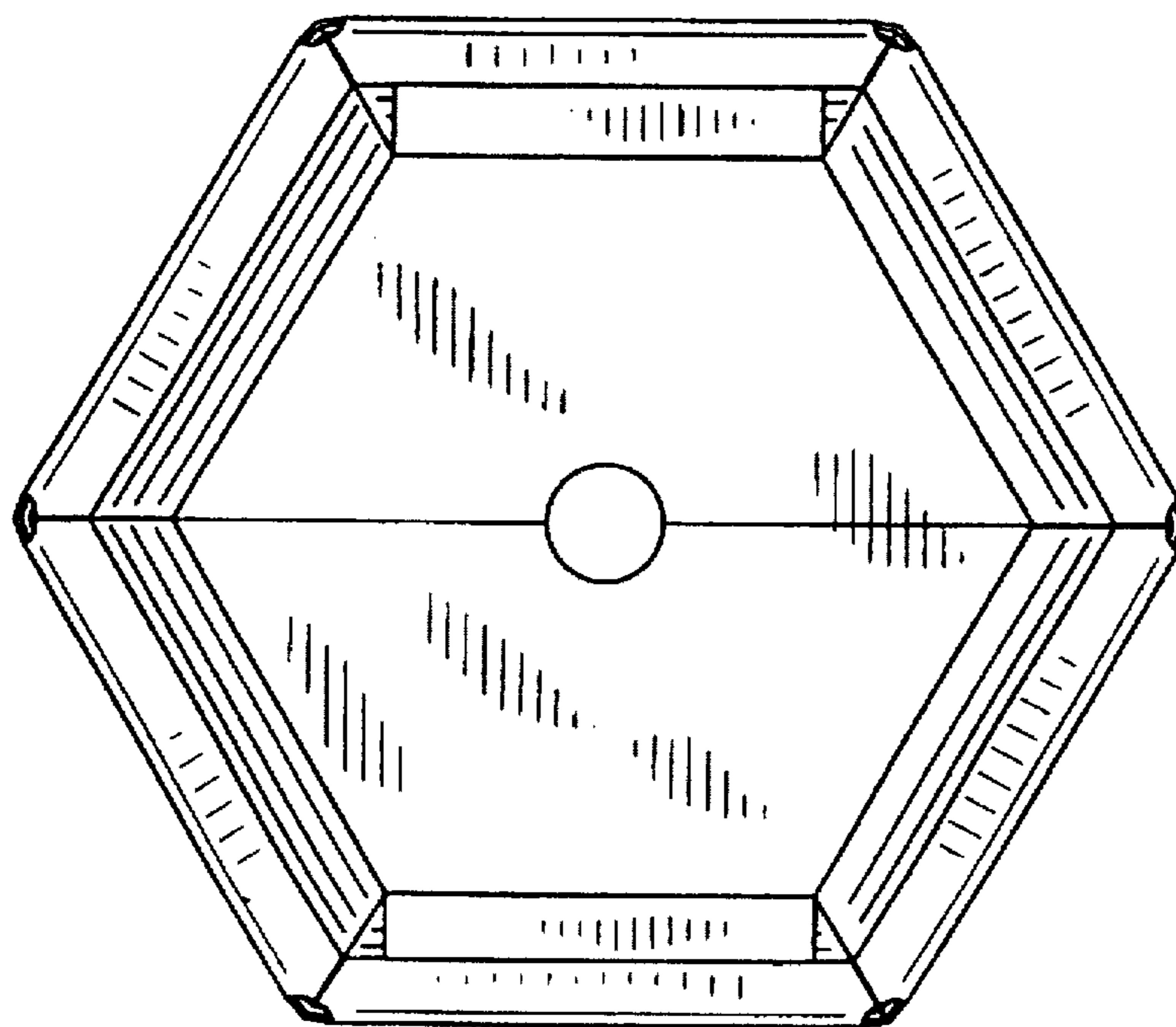

FIG. 5

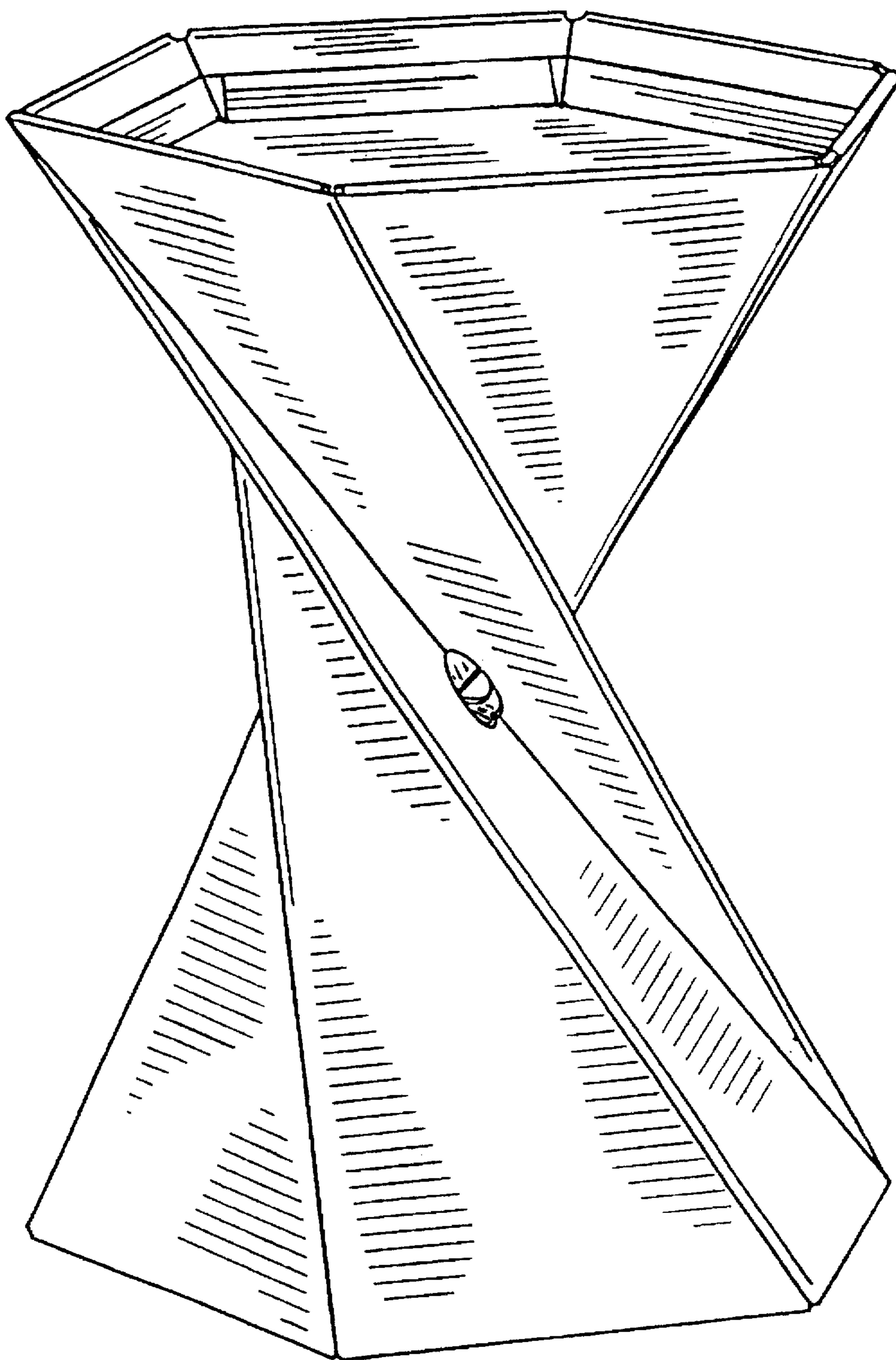

FIG. 6