



US00D391092S

# United States Patent [19]

[11] Patent Number: **Des. 391,092**

Natuzzi et al.

[45] Date of Patent: **\*\*Feb. 24, 1998**

[54] SEAT

[75] Inventors: **Pasquale Natuzzi; Raffaella Lucarelli**,  
both of Santeramo In Colle, Italy

[73] Assignee: **Industrie Natuzzi, Spa**, Bari, Italy

[\*\*] Term: **14 Years**

[21] Appl. No.: **63,612**

[22] Filed: **Dec. 11, 1996**

[51] LOC (6) Cl. .... **06-01**

[52] U.S. Cl. .... **D6/381; D6/334**

[58] Field of Search ..... **D6/334, 335, 364,**  
**D6/371, 373, 381, 500, 501, 502; 297/232**

[56] **References Cited**

**U.S. PATENT DOCUMENTS**

D. 353,062	12/1994	Natuzzi et al. ....	D6/381
D. 360,774	8/1995	Natuzzi et al. ....	D6/381
D. 367,371	2/1996	Natuzzi et al. ....	D6/381
D. 380,104	6/1997	Natuzzi et al. ....	D6/381

**OTHER PUBLICATIONS**

- Natuzzi Model 1200, Oct., 1994, at International Home Furnishings Market in High Point, North Carolina.
- Natuzzi Model 1249, Oct., 1994, at International Home Furnishings Market in High Point, North Carolina.
- Natuzzi Model 1291, Mar., 1995, at International Home Furnishings Market in High Point, North Carolina.
- Natuzzi Model 1295, Mar., 1995, at International Home Furnishings Market in High Point, North Carolina.
- Natuzzi Model 1348, Sep., 1995, at International Home Furnishings Market in High Point, North Carolina.
- Natuzzi Model 1352, Sep., 1995, at International Home Furnishings Market in High Point, North Carolina.
- Natuzzi Model 1364, Oct., 1995, at International Home Furnishings Market in High Point, North Carolina.
- Natuzzi Model 1395, Mar., 1996, at International Home Furnishings Market in High Point, North Carolina.
- Natuzzi Model 1034, Apr., 1993, at International Home Furnishings Market in High Point, North Carolina.
- Natuzzi Model 1068, Oct., 1993, at International Home Furnishings Market in High Point, North Carolina.
- Natuzzi Model 1087, Oct., 1993, at International Home Furnishings Market in High Point, North Carolina.

- Natuzzi Model 1098, Oct., 1993, at International Home Furnishings Market in High Point, North Carolina.
- Natuzzi Model 1100, Oct., 1993, at International Home Furnishings Market in High Point, North Carolina.
- Natuzzi Model 1123, Jan., 1994, at International Home Furnishings Market in High Point, North Carolina.
- Natuzzi Model 1126, Jan., 1994, at International Home Furnishings Market in High Point, North Carolina.
- Natuzzi Model 1128, Jan., 1994, at International Home Furnishings Market in High Point, North Carolina.
- Natuzzi Model 1198, Oct., 1994, at International Home Furnishings Market in High Point, North Carolina.
- Natuzzi Model 880, Apr., 1991, at International Home Furnishings Market in High Point, North Carolina.
- Natuzzi Model 734, Apr., 1990, at International Home Furnishings Market in High Point, North Carolina.
- Natuzzi Model 798, Oct., 1990, at International Home Furnishings Market in High Point, North Carolina.

*Primary Examiner*—Gary D. Watson

*Attorney, Agent, or Firm*—Bell Seltzer Intellectual Property Law Group; Alston & Bird LLP

[57] **CLAIM**

The ornamental design for a seat, as shown and described.

**DESCRIPTION**

FIG. 1 is a front perspective view of a seat showing our new design in the form of a sofa;  
 FIG. 2 is a front elevational view thereof;  
 FIG. 3 is a top plan view thereof;  
 FIG. 4 is a right side elevational view, the left side being a mirror image thereof;  
 FIG. 5 is a rear perspective view thereof;  
 FIG. 6 is a front elevational view of a seat showing our new design in the form of a loveseat; and,  
 FIG. 7 is a front elevational view of a seat showing our new design in the form of a chair.

The broken lines shown herein are for illustrative purposes only and form no part of the claimed design.  
 The rear views of FIGS. 6 and 7 are like FIG. 5, the difference being a matter of length.  
 The end views of FIGS. 6 and 7 are like that shown in FIG. 4.

FIGS. 1 and 5 have been shown on an enlarged scale with respect to the other views.

**1 Claim, 3 Drawing Sheets**

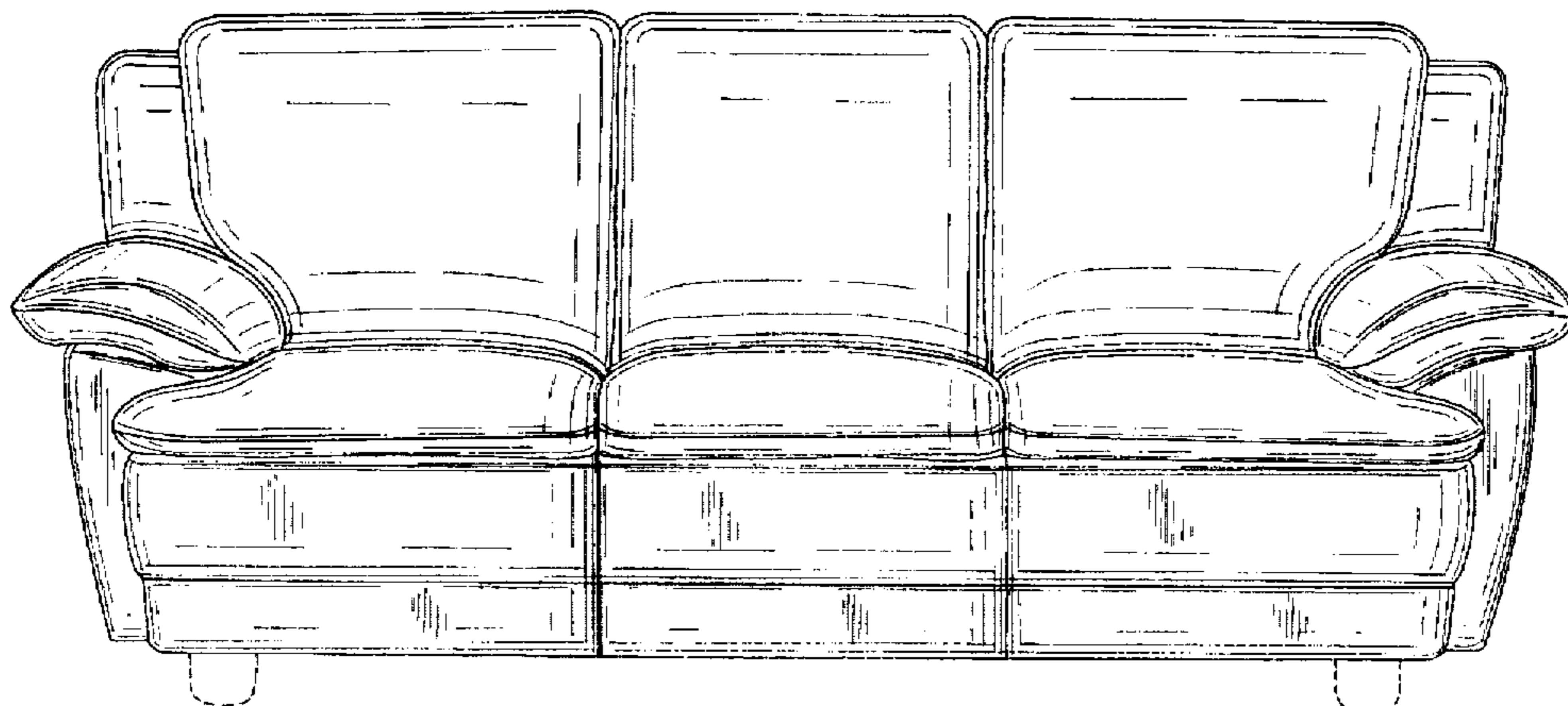

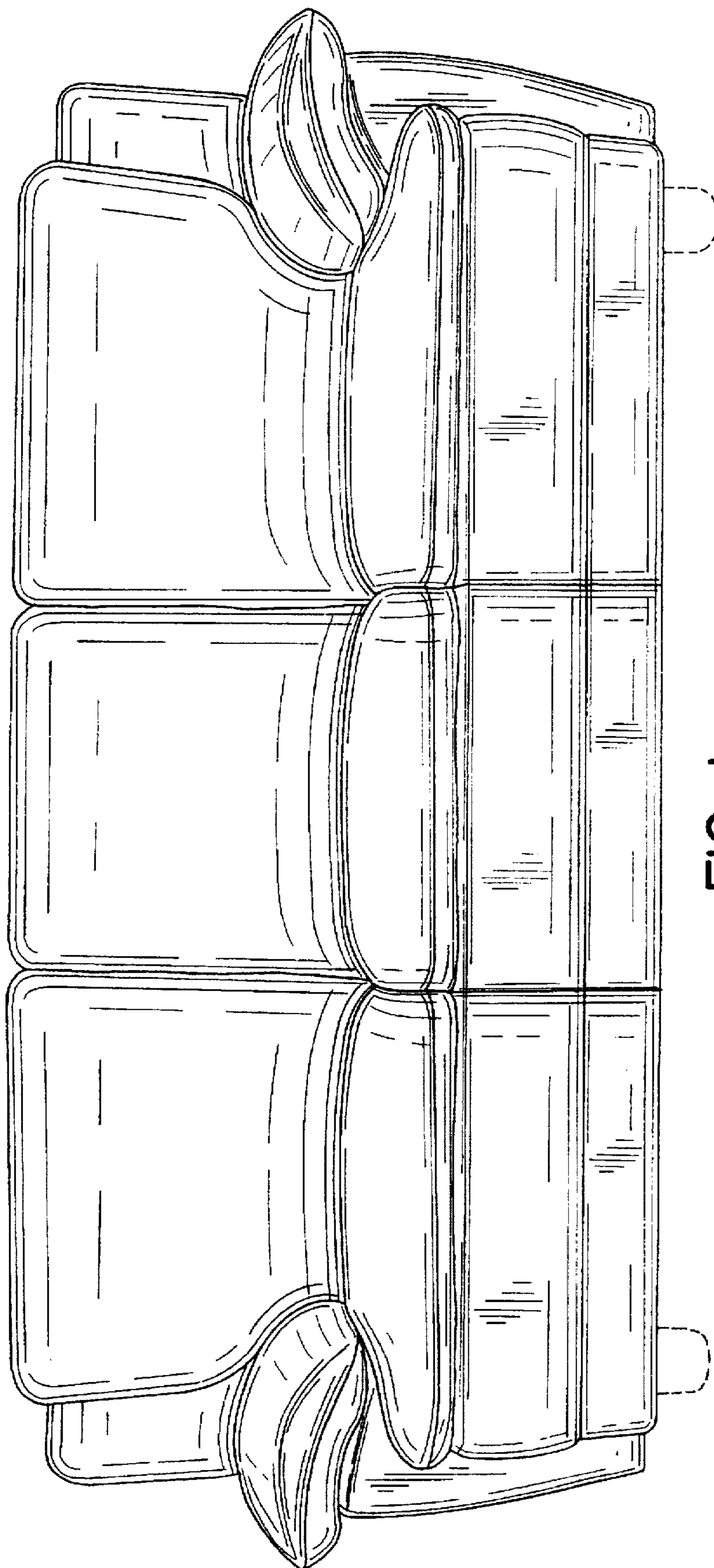

FIG. 1.



FIG. 2.

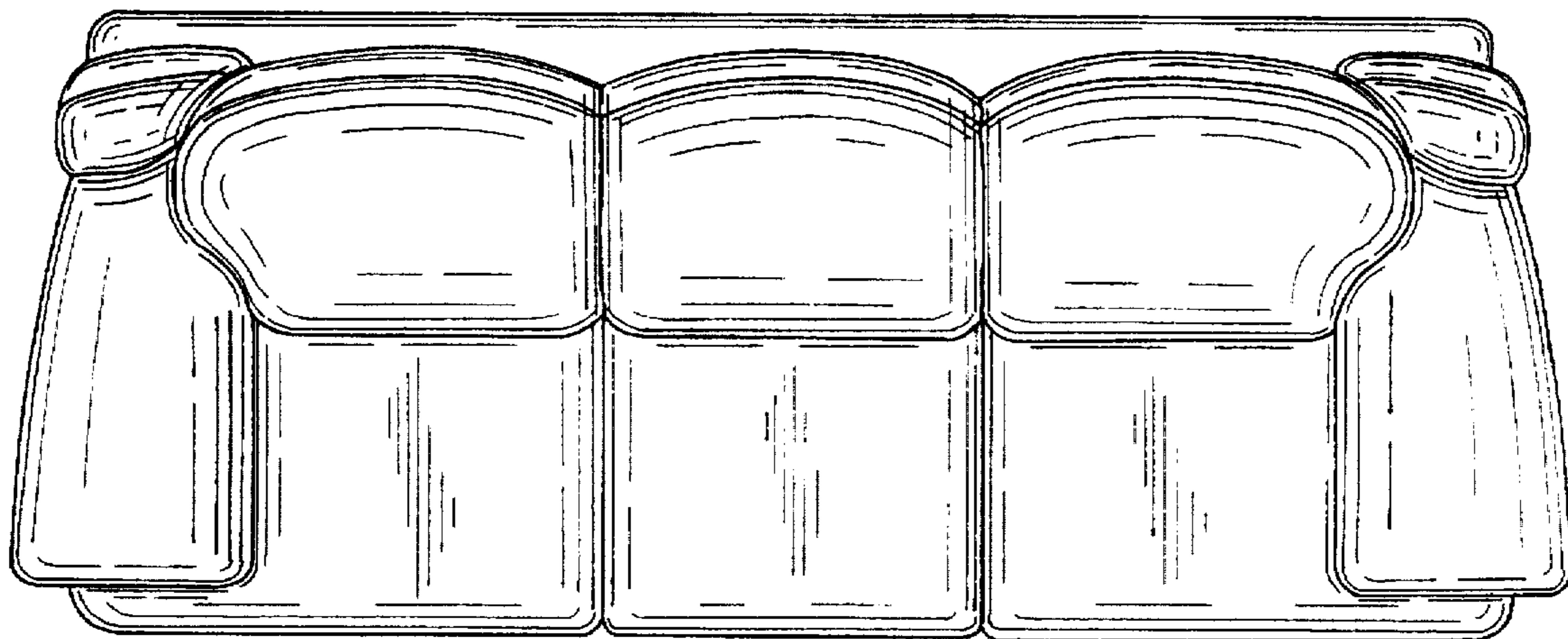

FIG. 3.

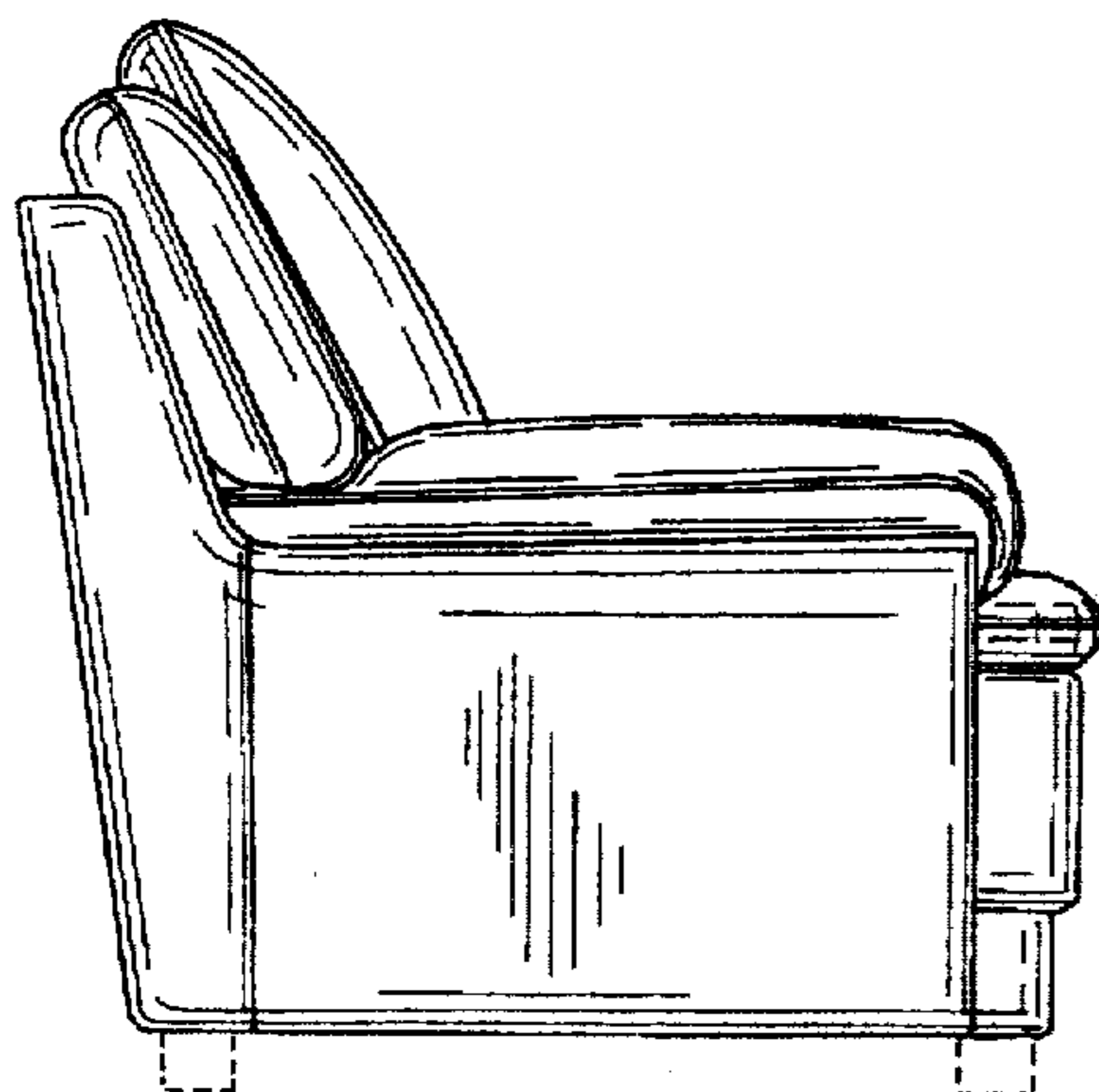

FIG. 4.

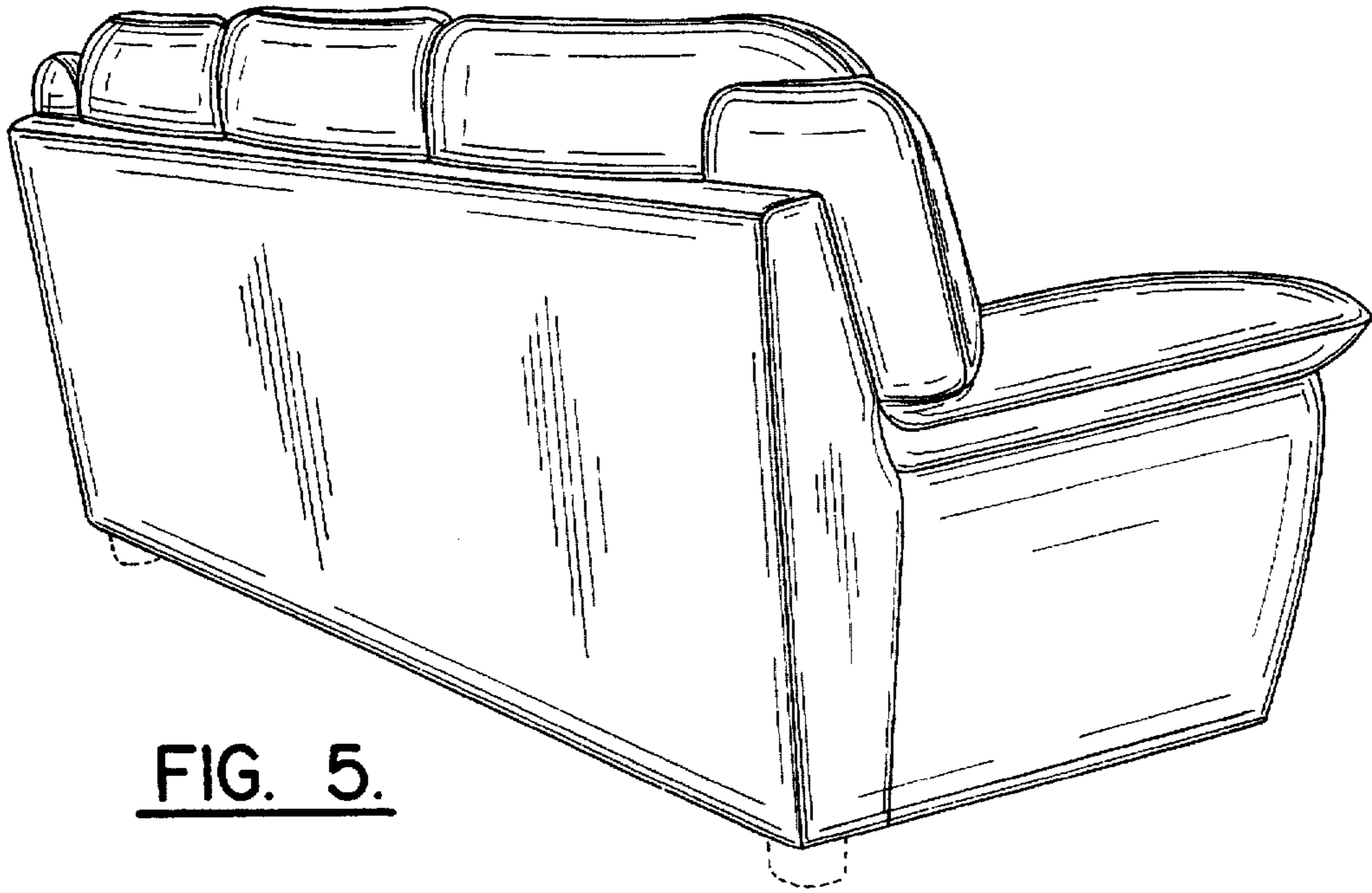

FIG. 5.

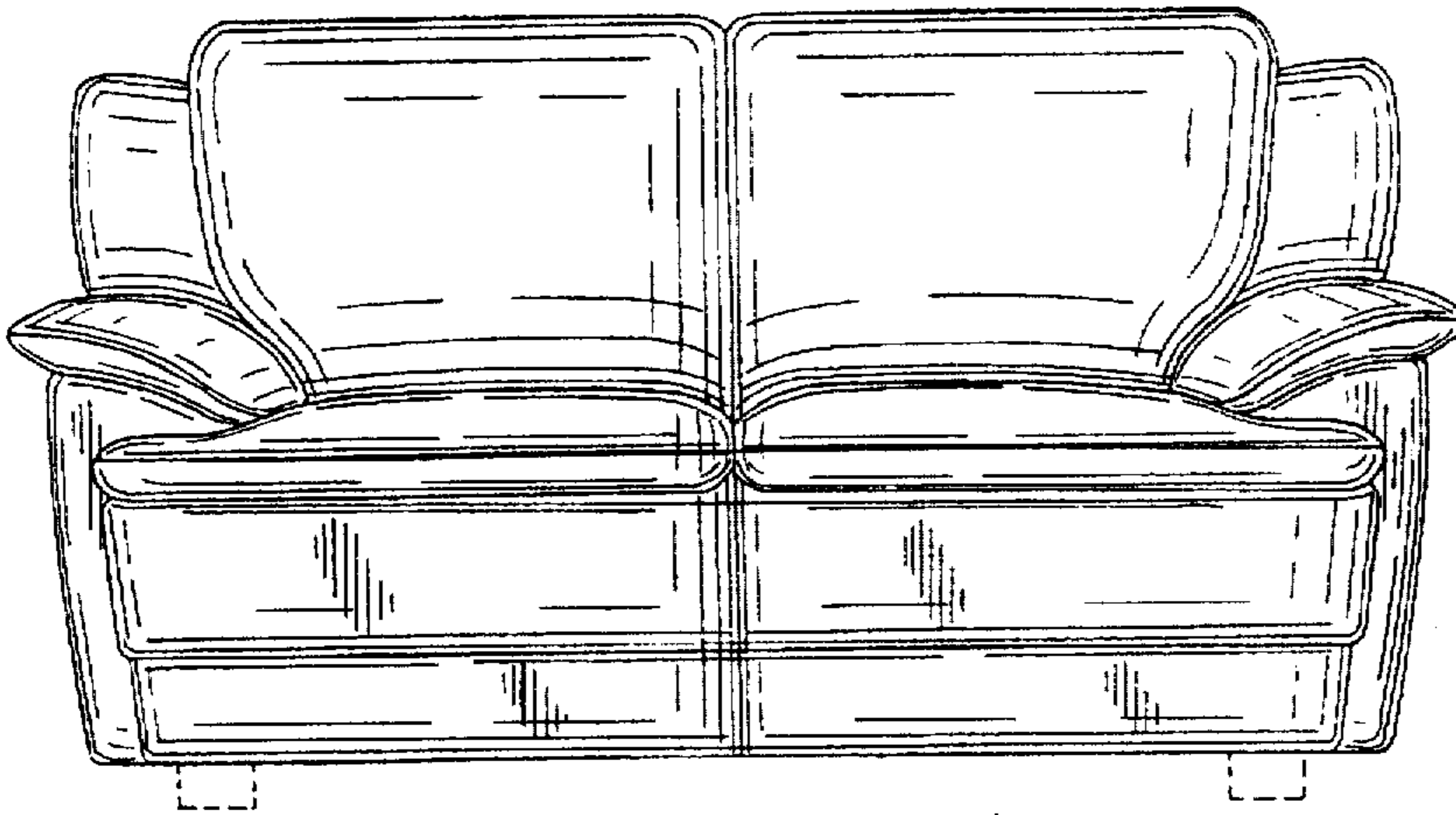

FIG. 6.

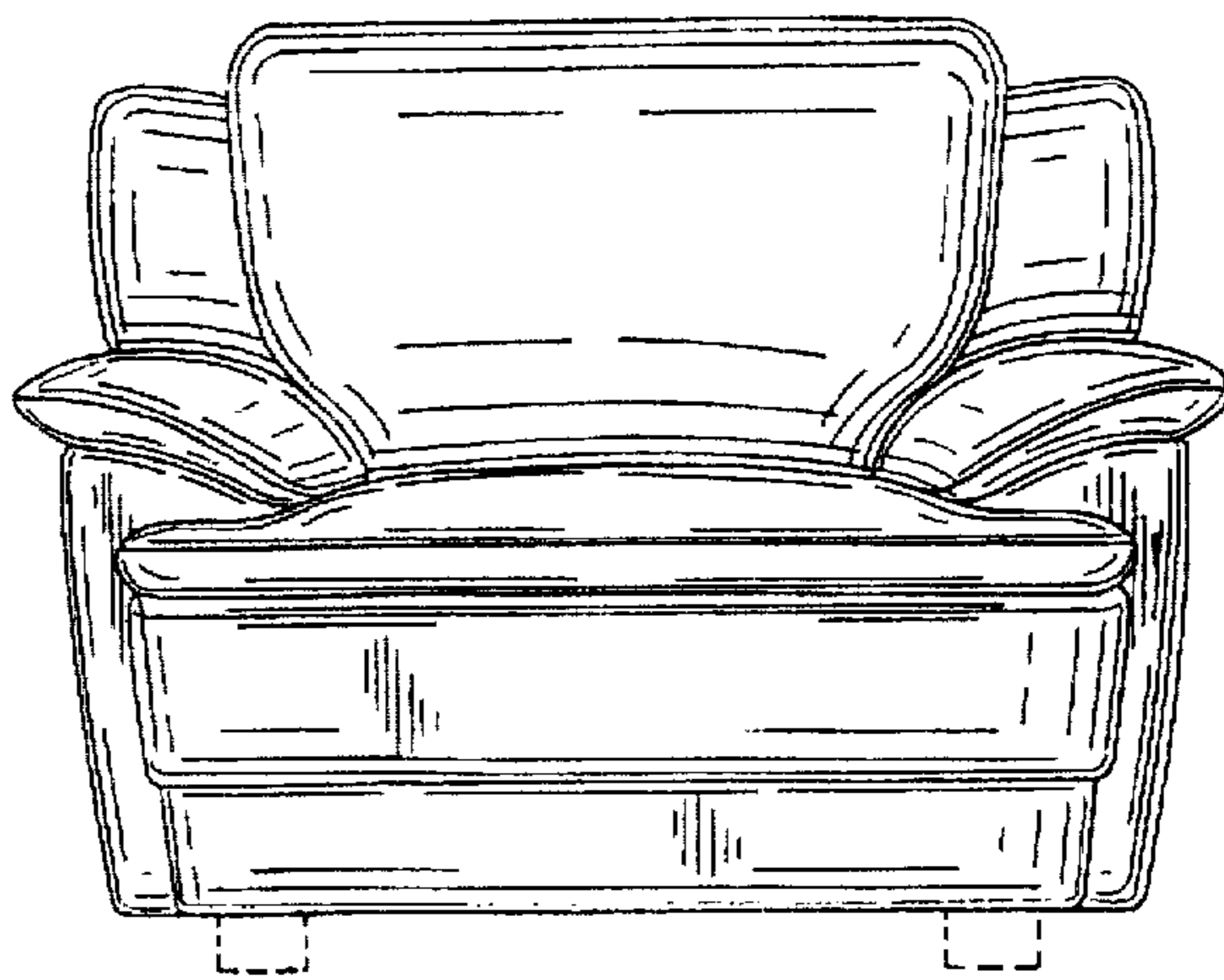

FIG. 7.