



US00D391009S

# United States Patent [19]

Liu

[11] Patent Number: **Des. 391,009**

[45] Date of Patent: **\*\*Feb. 17, 1998**

[54] **SUCTION CUP LIGHT HOLDER**

[76] Inventor: **Jackie Liu**, P.O. Box 87-432, Taipei, Taiwan

[\*\*] Term: **14 Years**

[21] Appl. No.: **69,826**

[22] Filed: **Apr. 17, 1997**

[51] LOC (6) Cl. .... **26-99**

[52] U.S. Cl. .... **D26/138**

[58] Field of Search ..... D8/367; D26/138; 362/396, 191; 248/301, 304, 205.5, 206.2

[56] **References Cited**

**U.S. PATENT DOCUMENTS**

- D. 297,616 9/1988 Doty et al. .... D26/138 X
- D. 328,363 7/1992 Young ..... D26/138

- D. 356,246 3/1995 Adams ..... D26/138 X
- 2,145,142 1/1939 Stout ..... 248/205.5

*Primary Examiner*—Holly Baynham  
*Attorney, Agent, or Firm*—Thomas Schneck

[57] **CLAIM**

The ornamental design for a suction cup light holder, as shown.

**DESCRIPTION**

FIG. 1 is a perspective view of the present invention of a suction cup light holder showing my design; FIG. 2 is a top plan view thereof; FIG. 3 is a front elevational view thereof; FIG. 4 is a bottom plan view thereof; FIG. 5 is a left side elevational view thereof; FIG. 6 is a right side elevational view thereof; and, FIG. 7 is a rear elevational view thereof.

**1 Claim, 3 Drawing Sheets**

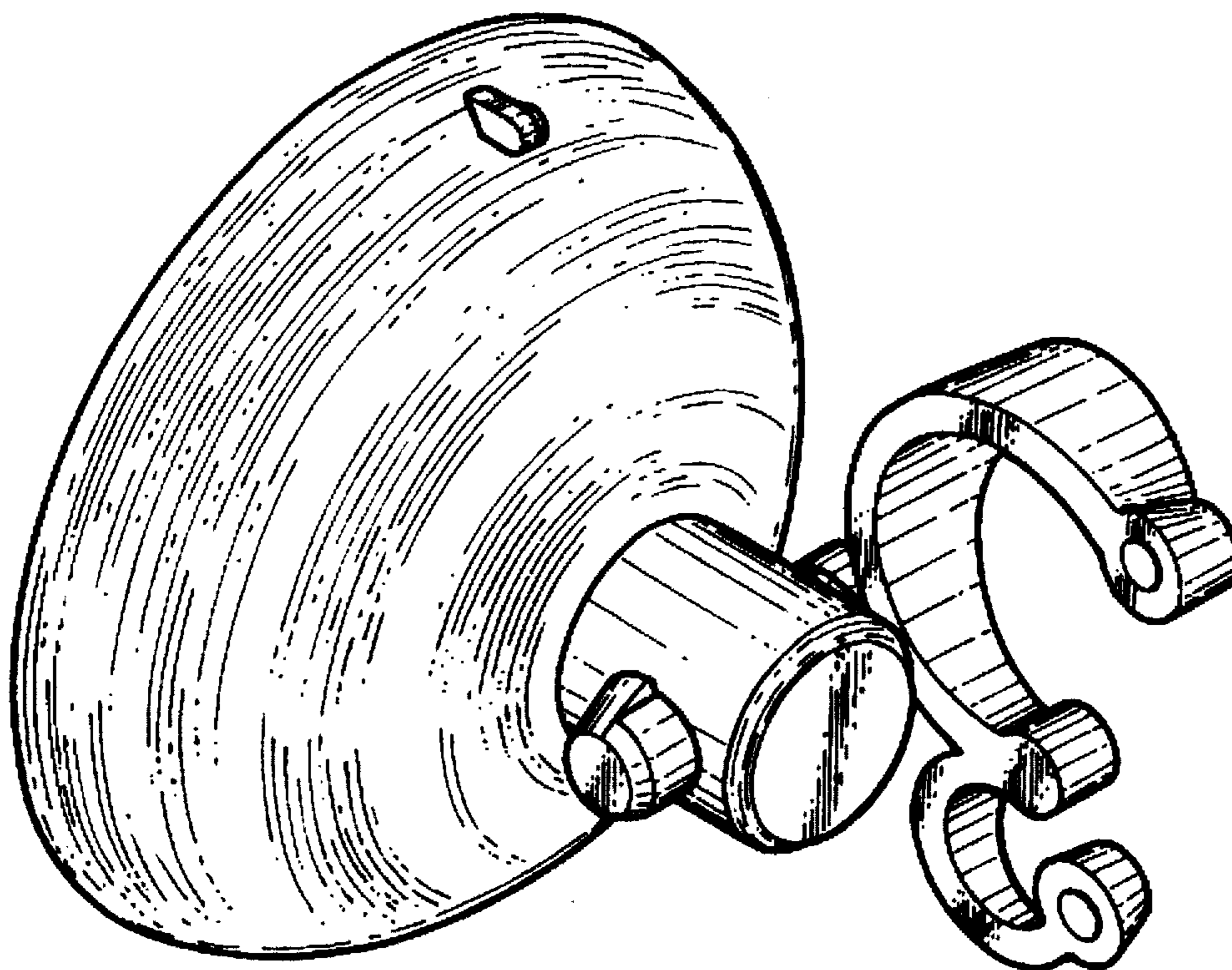

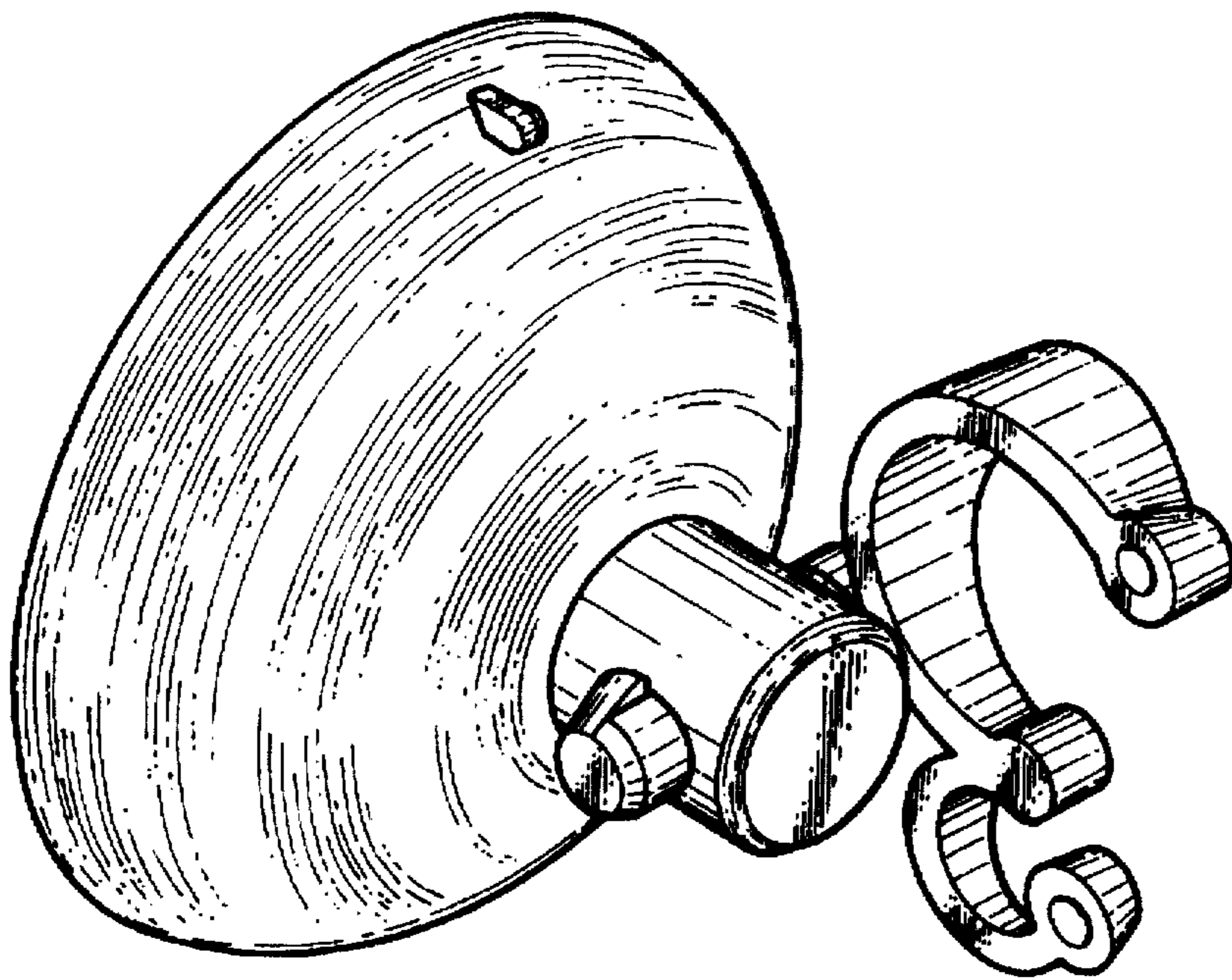

FIG. 1

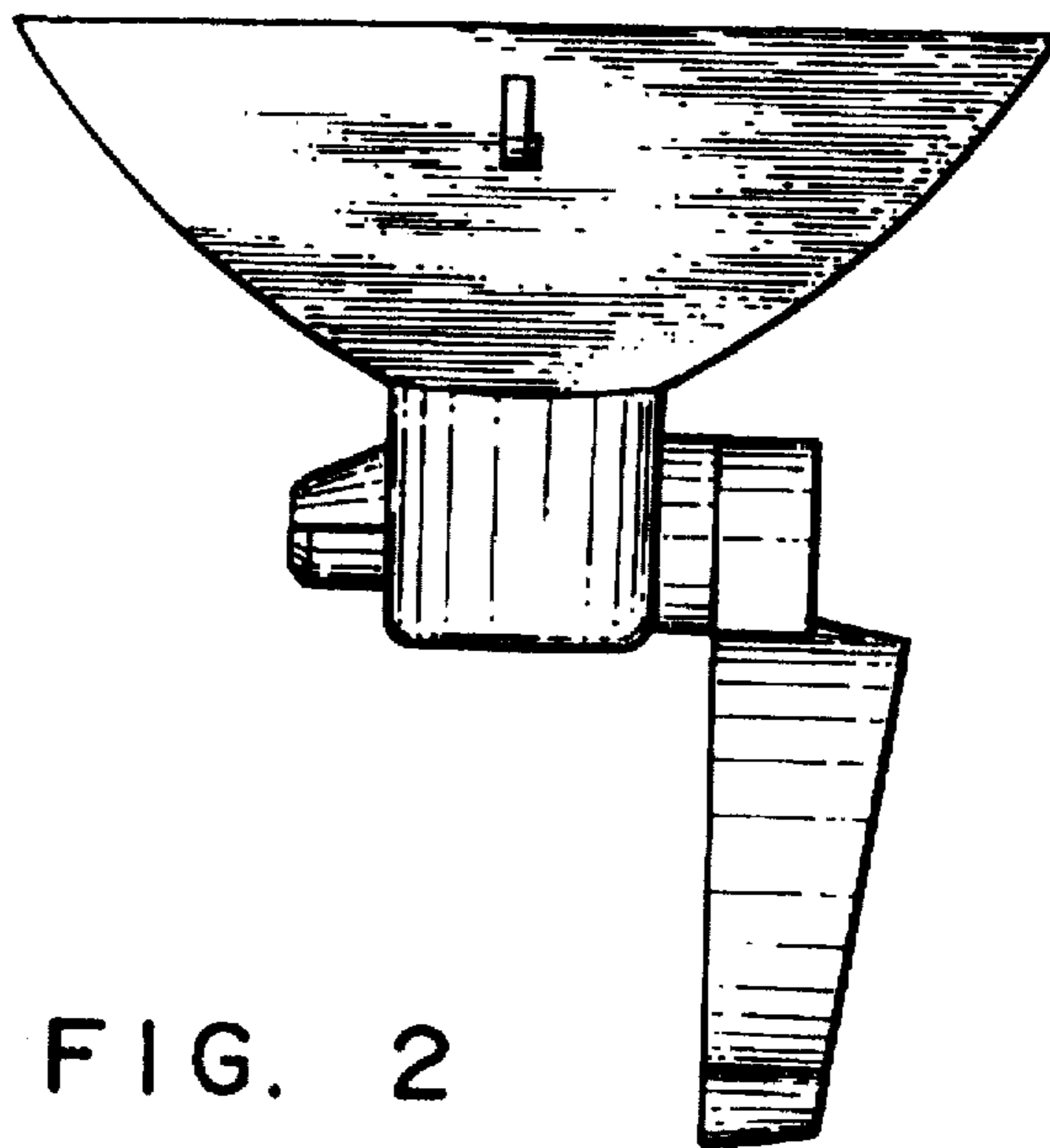

FIG. 2

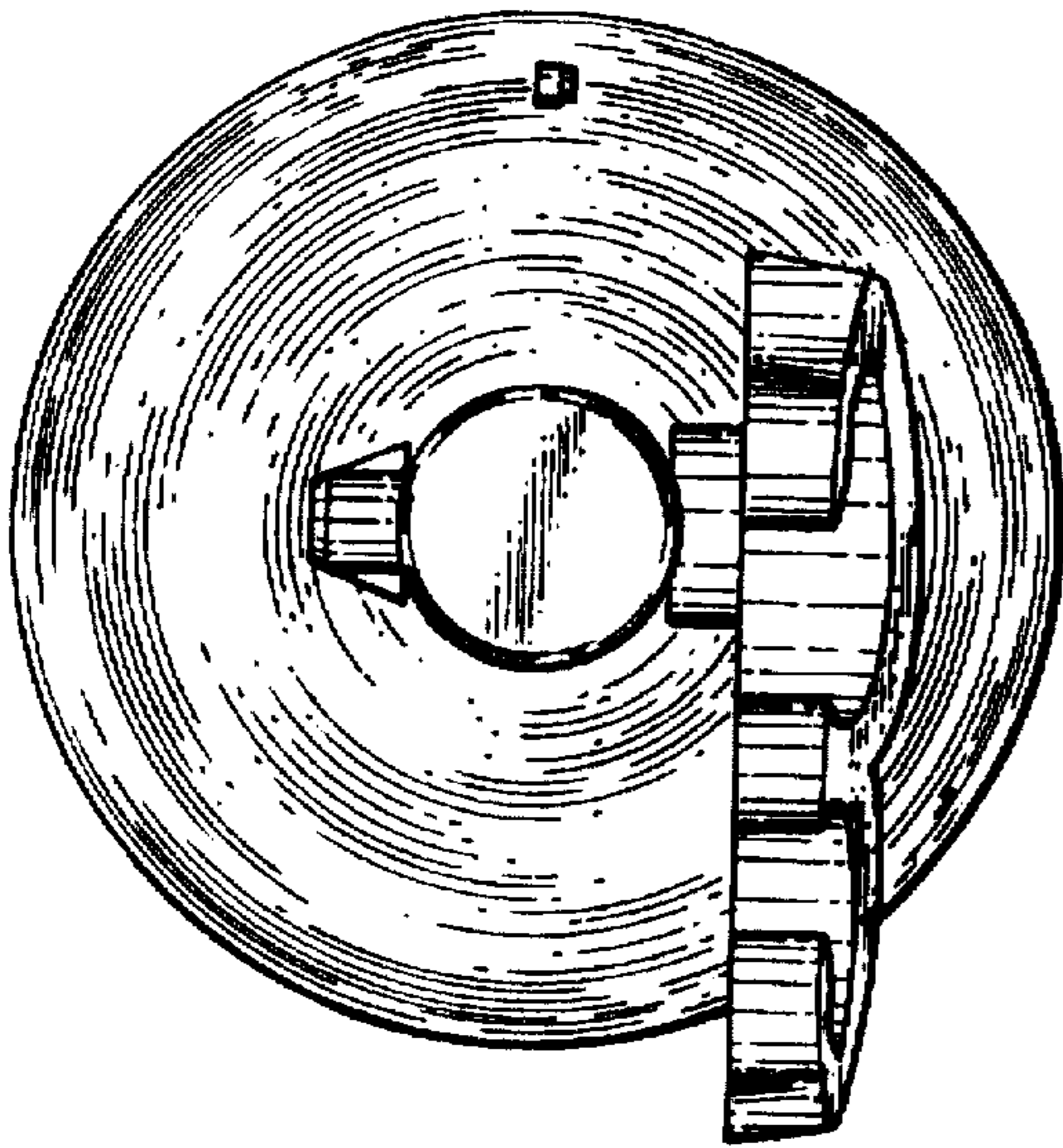

FIG. 3

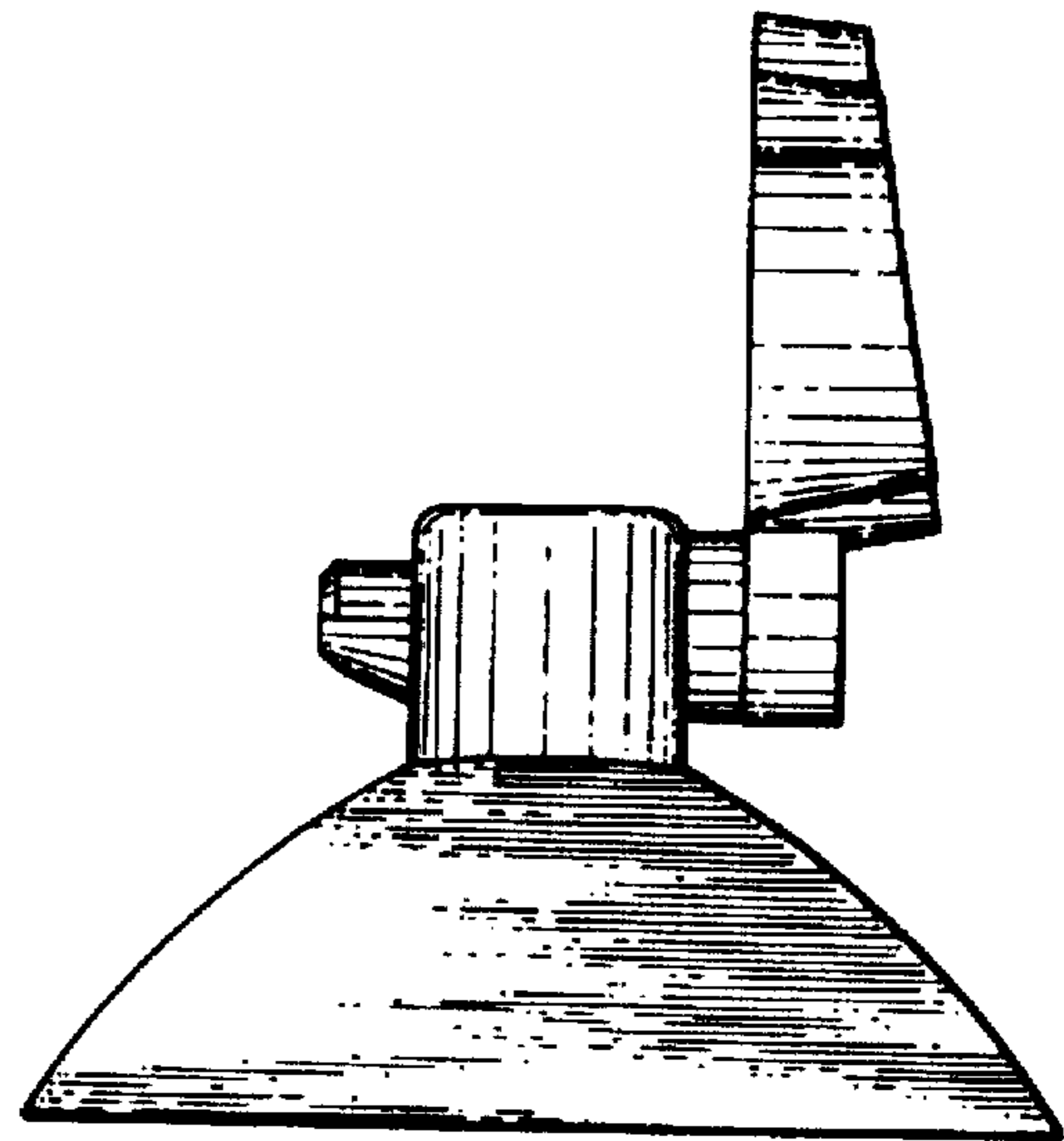

FIG. 4

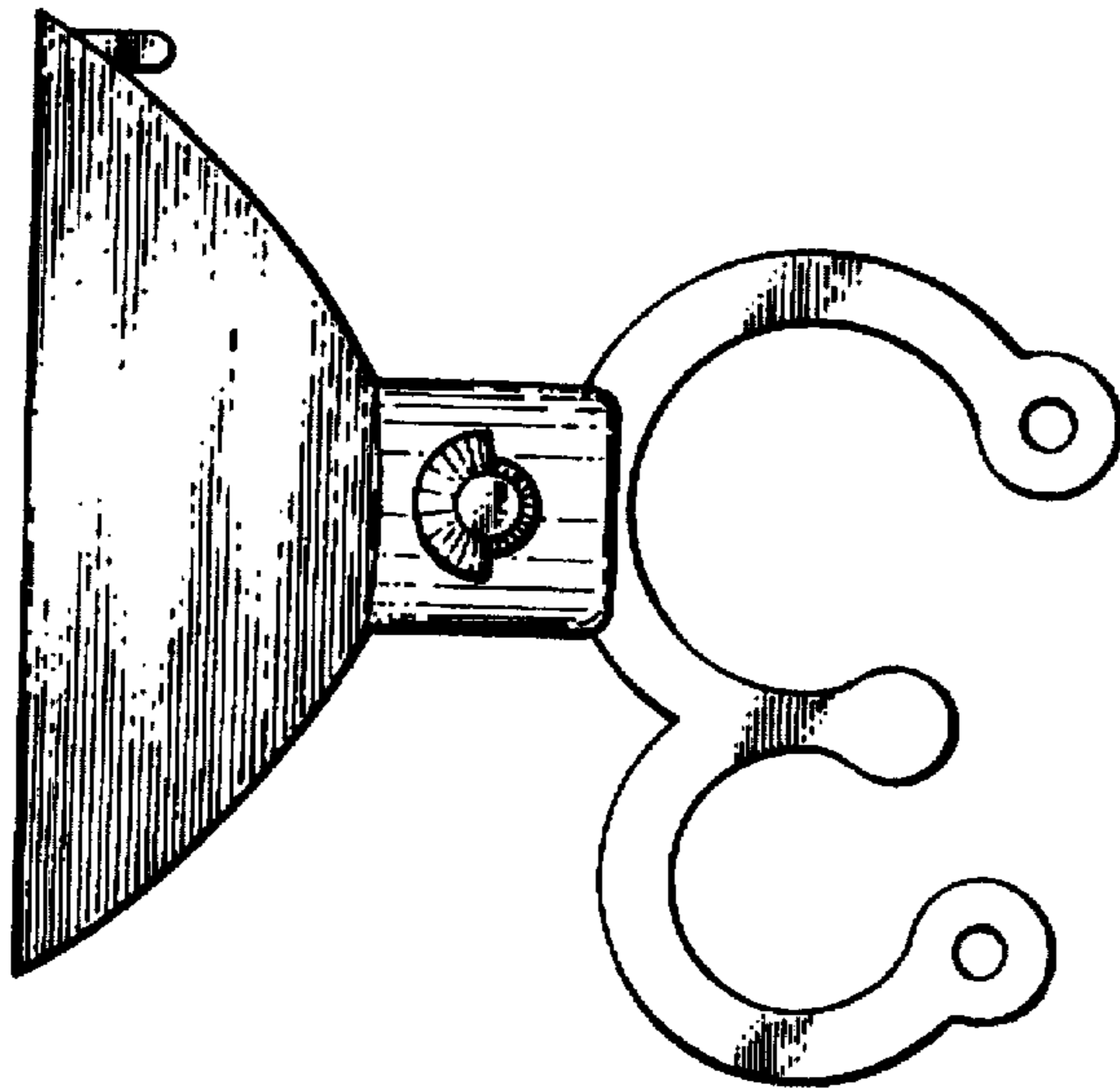

FIG. 5

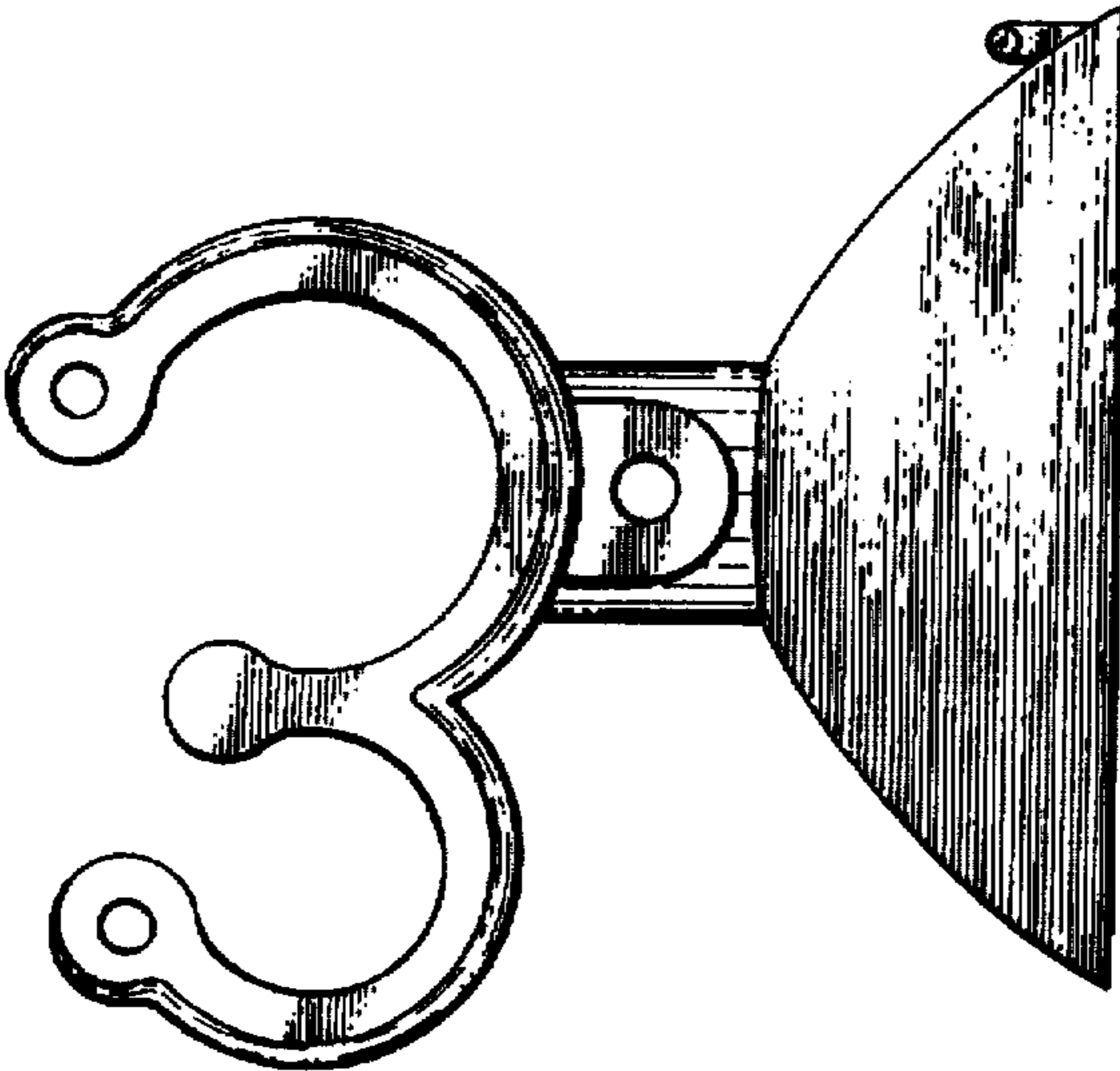

FIG. 6

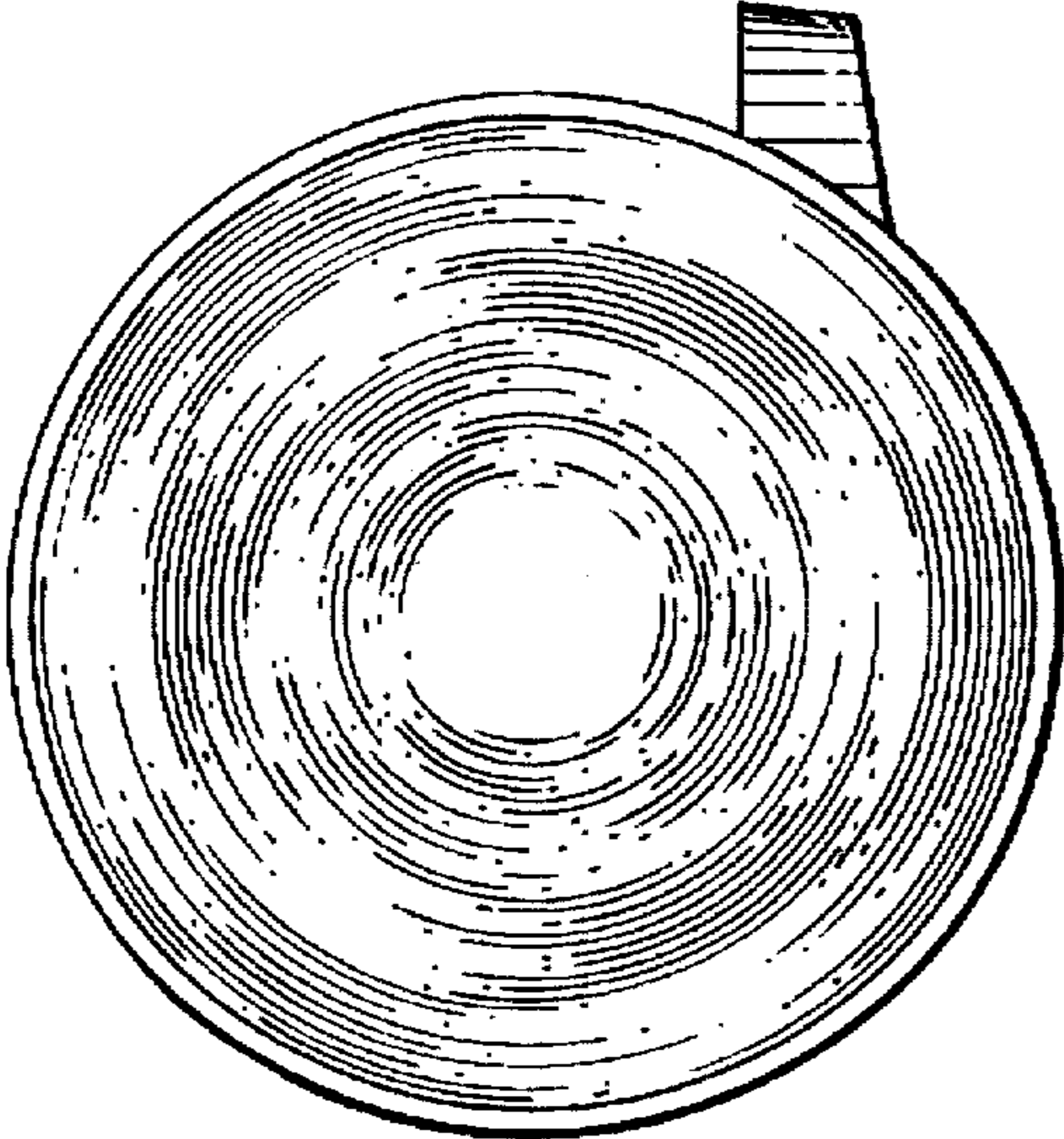

FIG. 7