



US00D390944S

United States Patent [19]

[11] Patent Number: **Des. 390,944**

Pickett et al.

[45] Date of Patent: ****Feb. 17, 1998**

[54] CEILING FAN

[75] Inventors: **Mark Pickett**, Rancho Palos Verdes;
Jan Jaspers-Fayer, Idyllwild, both of Calif.

[73] Assignee: **Minka Lighting, Inc.**, Corona, Calif.

[**] Term: **14 Years**

[21] Appl. No.: **61,106**

[22] Filed: **Oct. 16, 1996**

[51] LOC (6) Cl. **23-04**

[52] U.S. Cl. **D23/377; D23/379; D23/385**

[58] Field of Search **D23/377, 379, D23/385, 411; D7/576, 582; 416/5; 392/364; D26/81-86, 88, 59, 72, 73, 51**

[56] References Cited

U.S. PATENT DOCUMENTS

D. 341,991	12/1993	Frere	D7/576
D. 346,210	4/1994	Holbrook	D23/377
D. 346,651	5/1994	Pasquale	D23/379
5,433,585	7/1995	Yan	416/5

OTHER PUBLICATIONS

House + Garden, p. 66, Plate (A), right middle side of page, Sep. 1950.

Mikasa Tableware, Plate (B), bottom of page.

Woodward + Lothrop, Plate (C), top left side of page, Oct. 1991.

Great 2000 Enterprise, Inc. Adv. Flyer, Ceiling Fan (D).

Primary Examiner—Lisa Lichtenstein
Attorney, Agent, or Firm—Jenkins & Gilchrist, P.C.

[57] CLAIM

The ornamental design for a ceiling fan, as shown and described.

DESCRIPTION

FIG. 1 is a front perspective view of a ceiling fan incorporating my ornamental design;

FIG. 2 is a front perspective view of the ceiling fan of FIG. 1;

FIG. 3 is a first side view of the ceiling fan of FIG. 1;

FIG. 4 is a second side view of the ceiling fan of FIG. 1;

FIG. 5 is a third side view of the ceiling fan of FIG. 1;

FIG. 6 is an enlarged top view of the ceiling fan of FIG. 1; and,

FIG. 7 is an enlarged bottom view of the ceiling fan of FIG. 1.

The fan blades have been shown broken-away in FIGS. 1-7 to indicate indeterminate length.

1 Claim, 7 Drawing Sheets

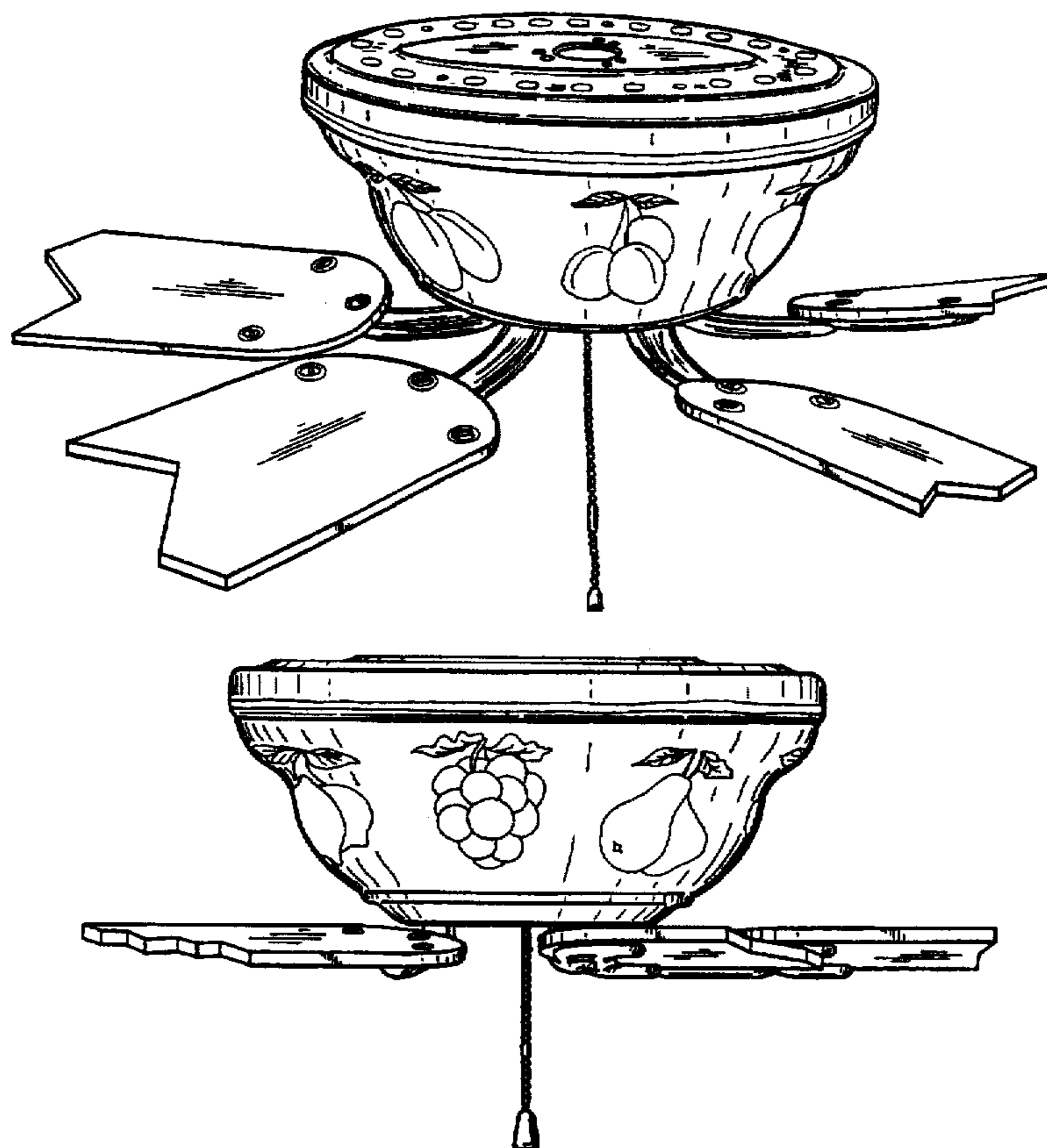

FIG. 1

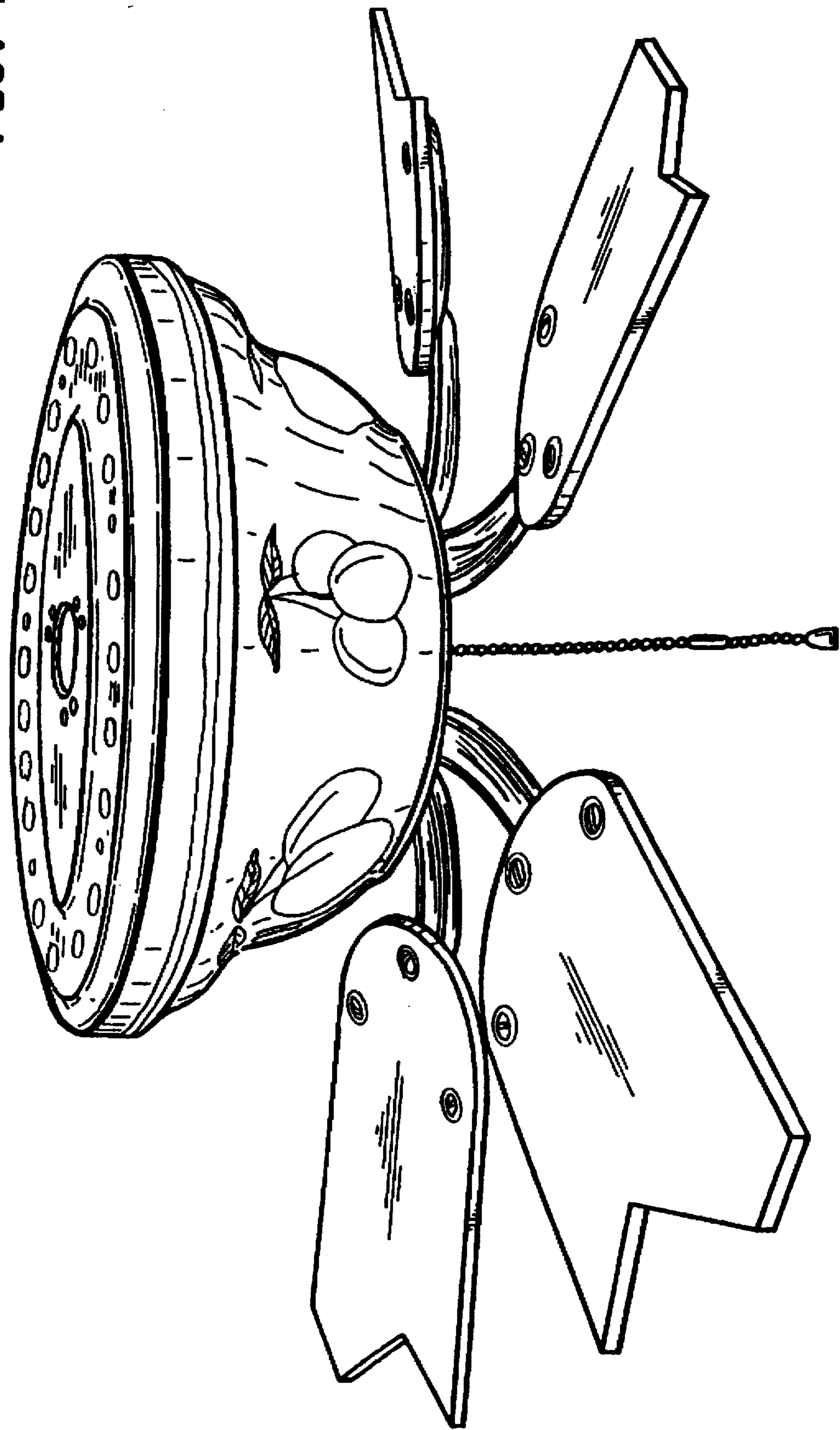

FIG. 2

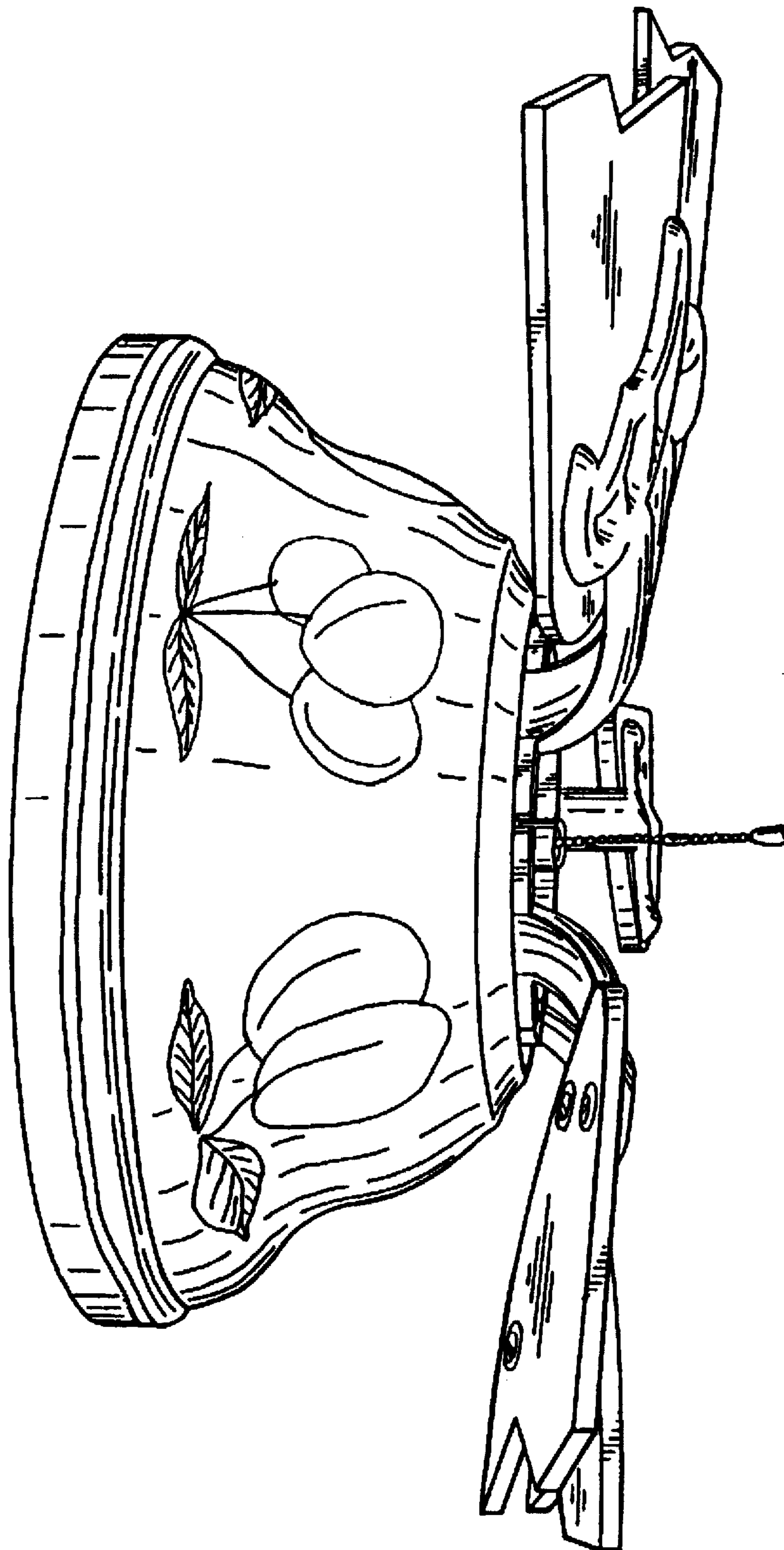

FIG. 3

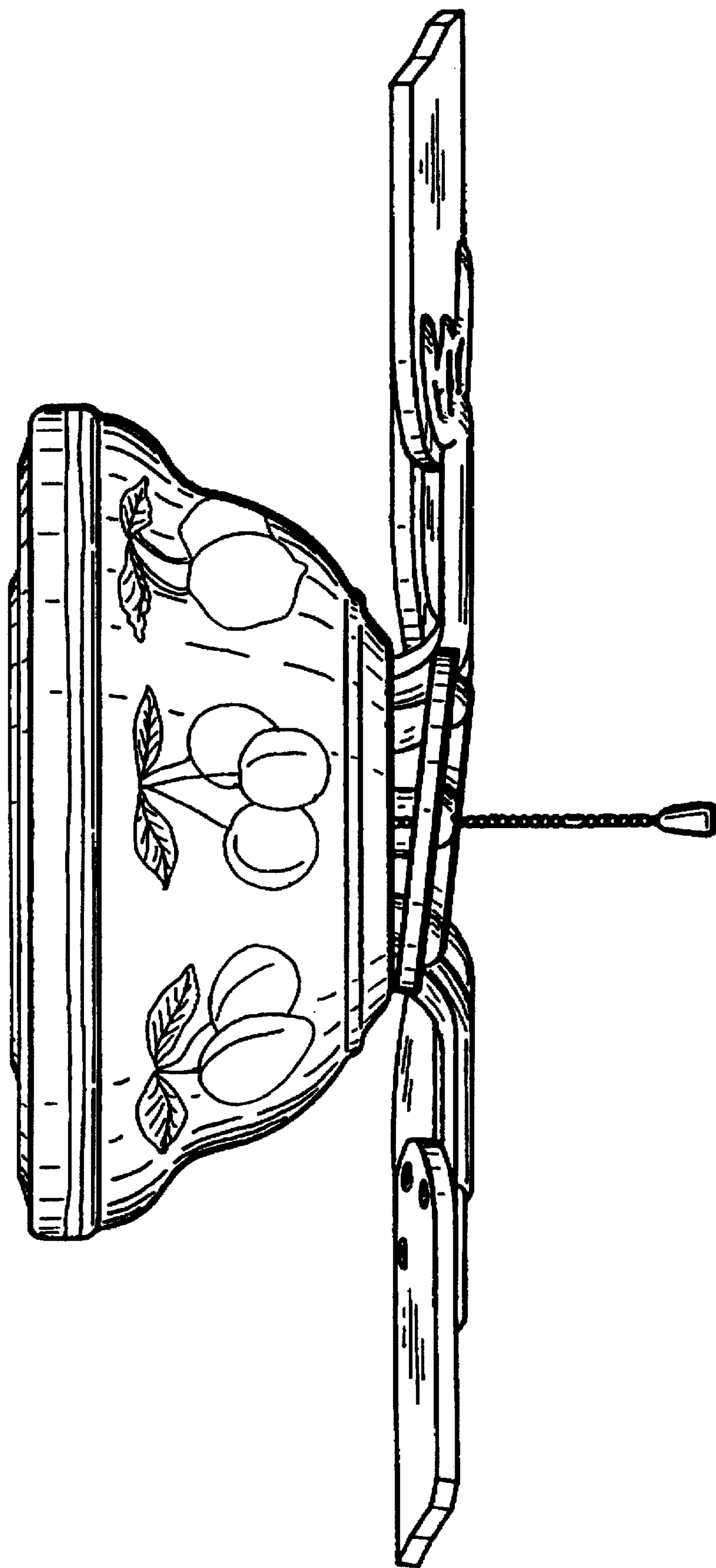

FIG. 4

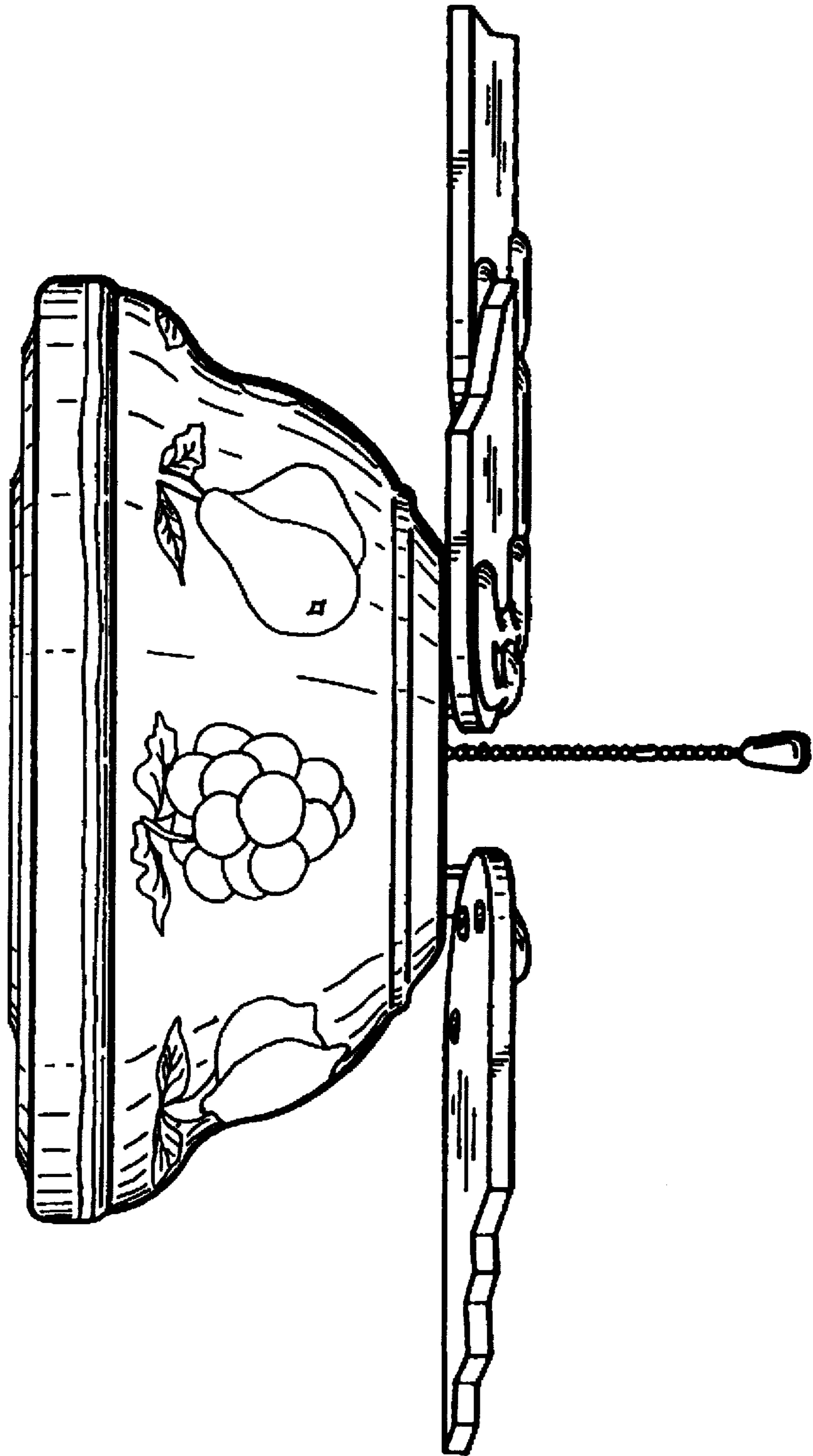

FIG. 5

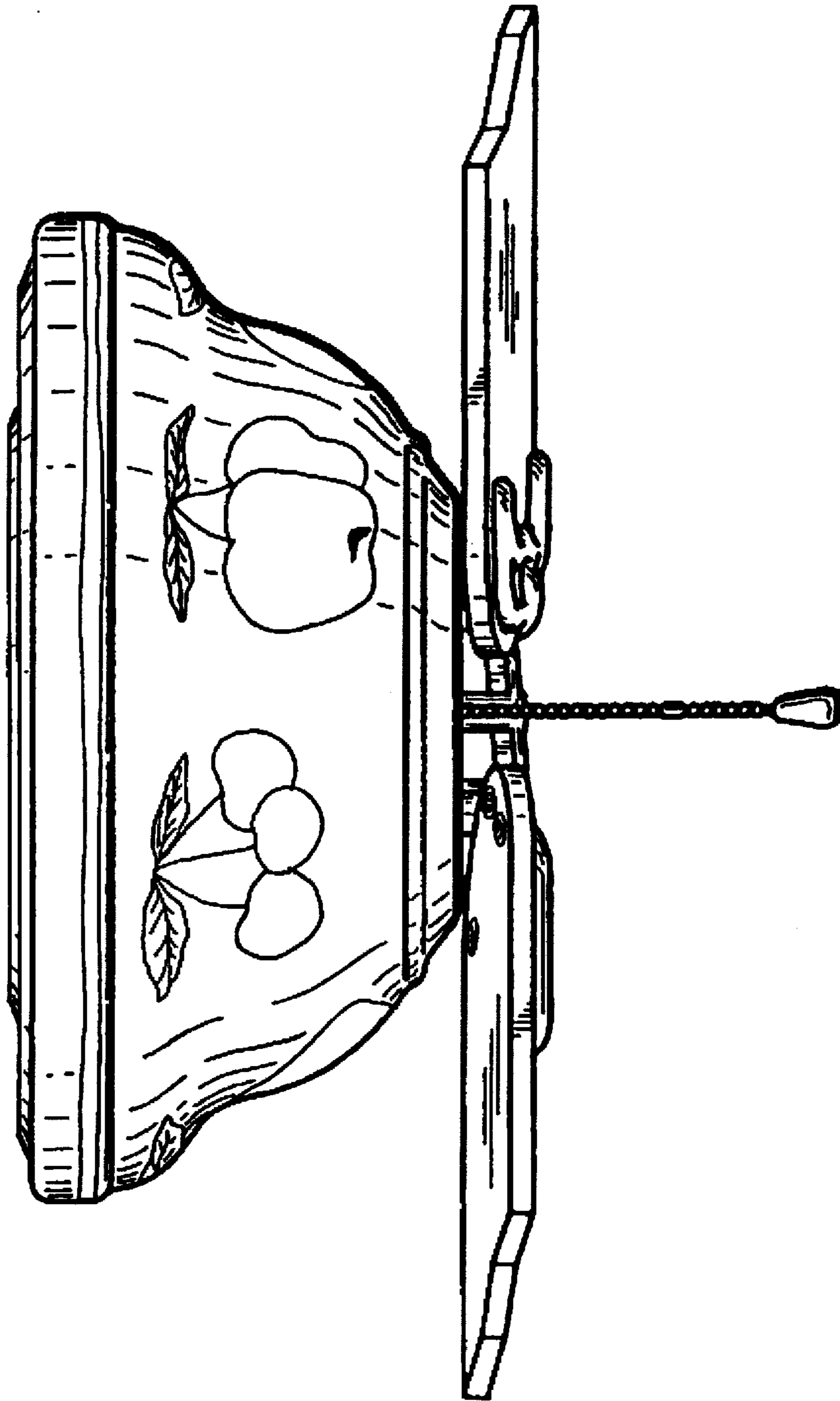

FIG. 6

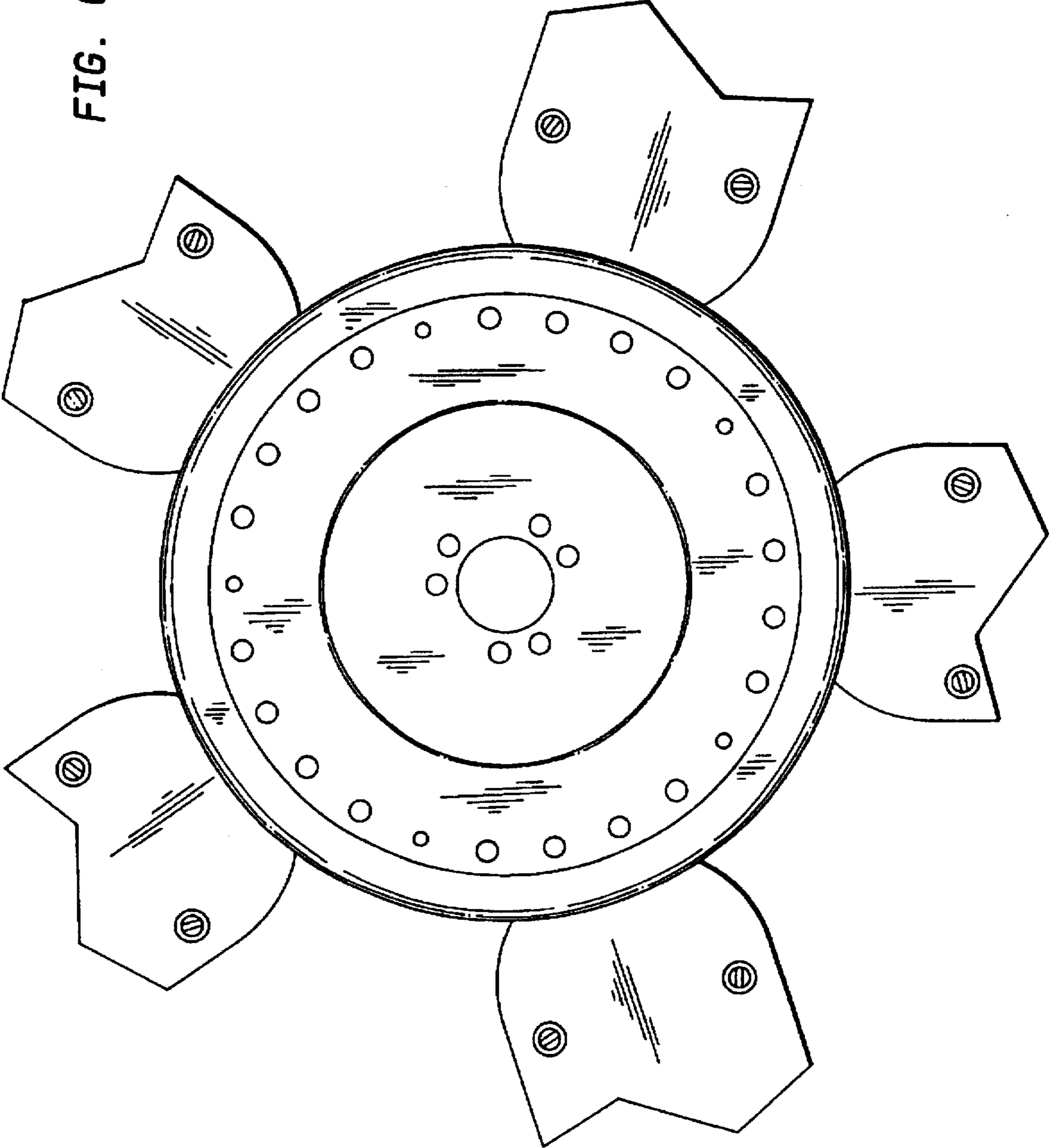

FIG. 7

