



US00D390928S

United States Patent [19]
Slothower

[11] **Patent Number: Des. 390,928**
[45] **Date of Patent: **Feb. 17, 1998**

- [54] **LAVATORY**
- [75] **Inventor: Erich D. Slothower, Sheboygan, Wis.**
- [73] **Assignee: Sterling Plumbing Group, Inc., Rolling Meadows, Ill.**
- [**] **Term: 14 Years**
- [21] **Appl. No.: 58,235**
- [22] **Filed: Aug. 9, 1996**
- [51] **LOC (6) Cl. 23-02**
- [52] **U.S. Cl. D23/284**
- [58] **Field of Search D23/284, 285, D23/290, 291, 293.1, 292; 4/619, 624, 626, 638-650**

[56] **References Cited**

U.S. PATENT DOCUMENTS

- D. 292,609 11/1987 Koladd D23/293.1
- D. 325,247 4/1992 Stainson D23/293.1
- D. 337,377 7/1993 Bonnell et al. D23/284
- D. 340,970 11/1993 Konler, Jr. et al. D23/293.1
- D. 347,273 5/1994 Wei D23/293.1

OTHER PUBLICATIONS

Jacob Delafon catalog ad, p. 84, showing a "Brive 2" pedestal lavatory, admitted prior art.
 Kohler catalog ad, p. 146, showing a "Portrait" pedestal lavatory, admitted prior art.

Undated Sterling ad showing a drop-in lavatory, admitted prior art.

Primary Examiner—Louis S. Zarfes
Assistant Examiner—Eric Watterson
Attorney, Agent, or Firm—Quarles & Brady

[57] **CLAIM**

The ornamental design for a lavatory, as shown and described.

DESCRIPTION

FIG. 1 is a left, top, front perspective view of a lavatory embodying my new design;
 FIG. 2 is a top plan view thereof;
 FIG. 3 is a front elevational view thereof;
 FIG. 4 is a right side elevational view thereof, the left side elevational view being a mirror image of the right side shown;
 FIG. 5 is a cross-sectional view taken along line 5—5 of FIG. 2; and,
 FIG. 6 is a cross-sectional view taken along line 6—6 of FIG. 2; and,
 The broken line representations of holes in FIGS. 1 and 2 are for purposes of illustration only, and form no part of the claimed design.

1 Claim, 2 Drawing Sheets

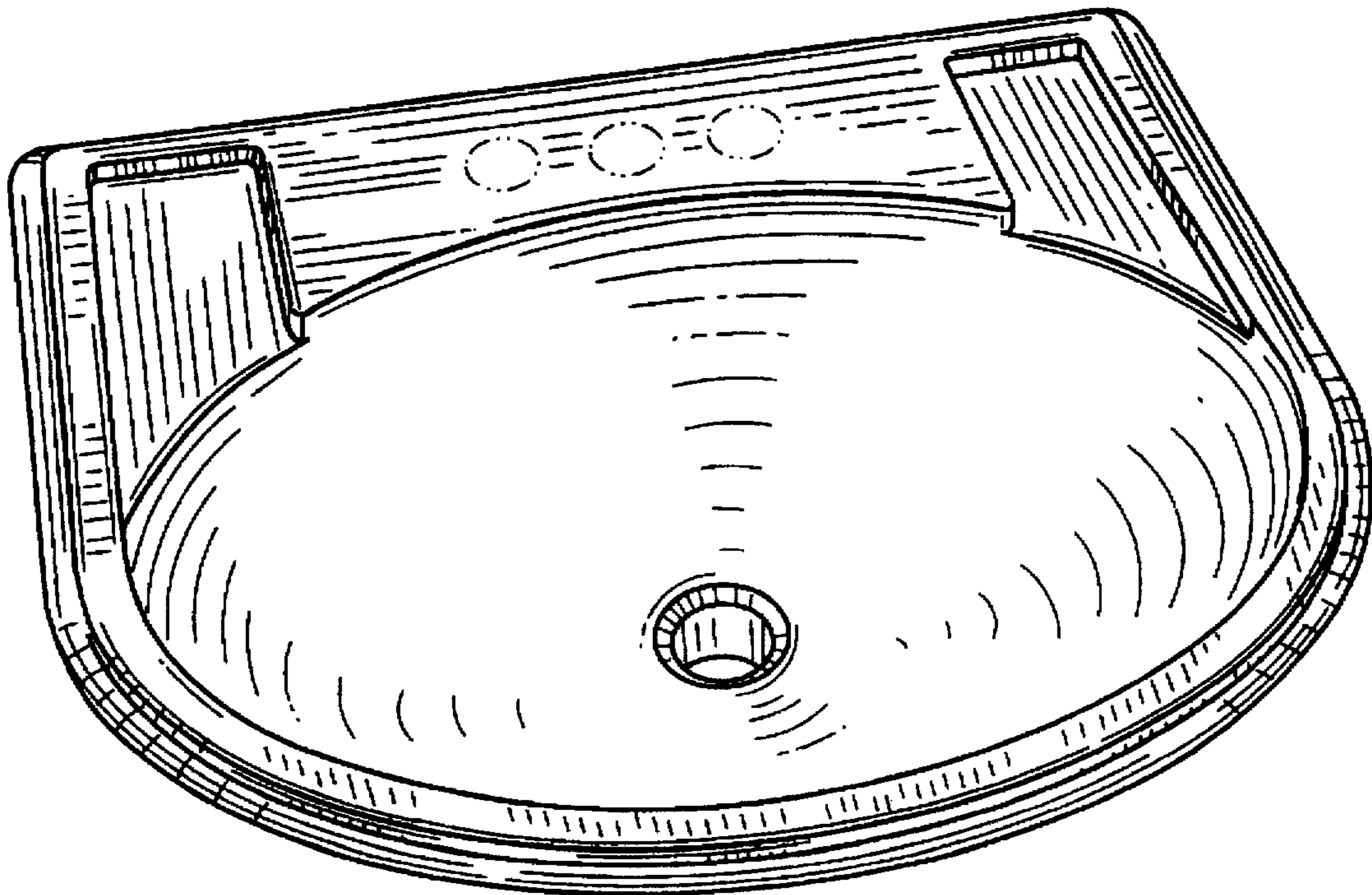

FIG. 1

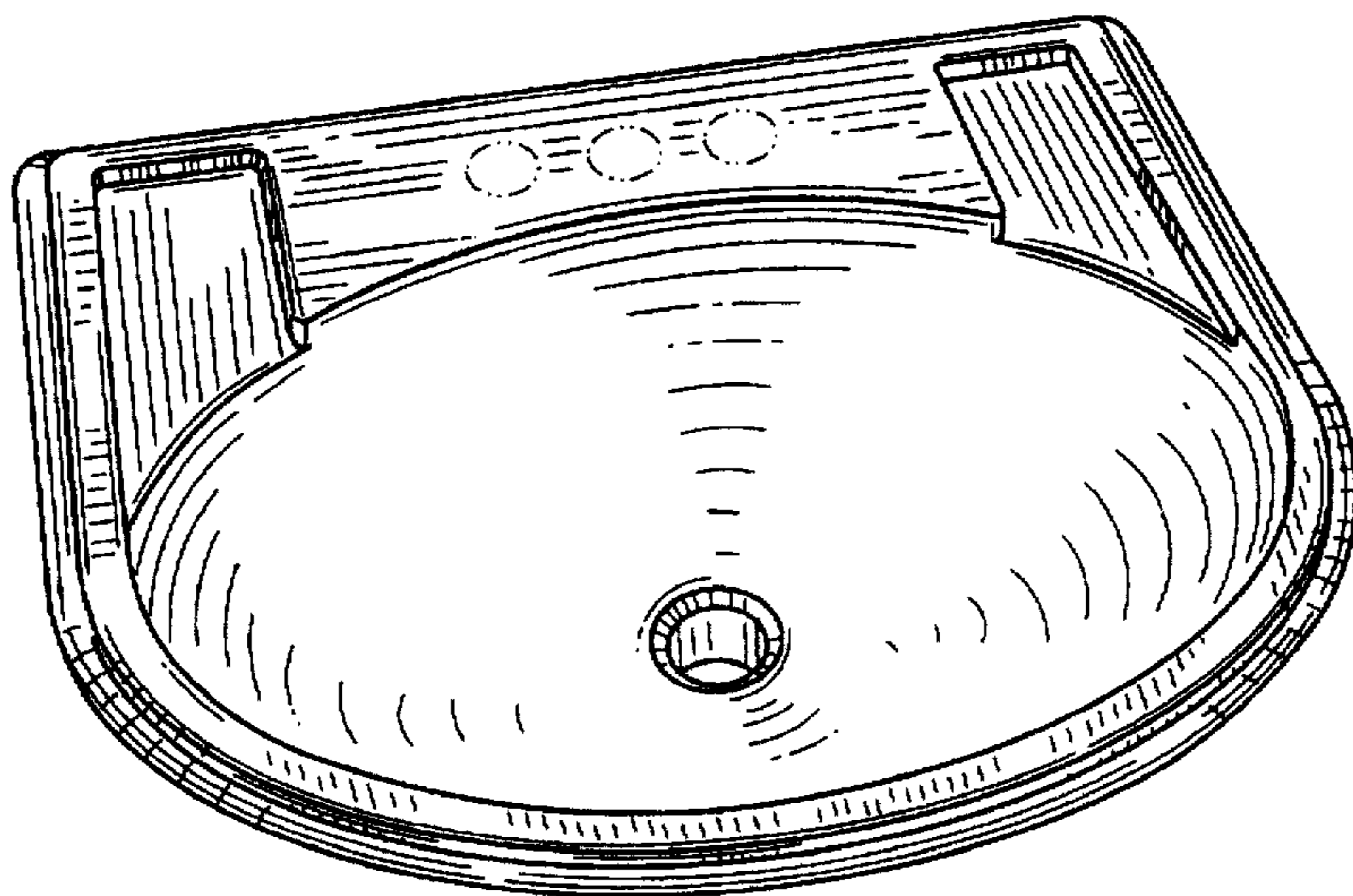
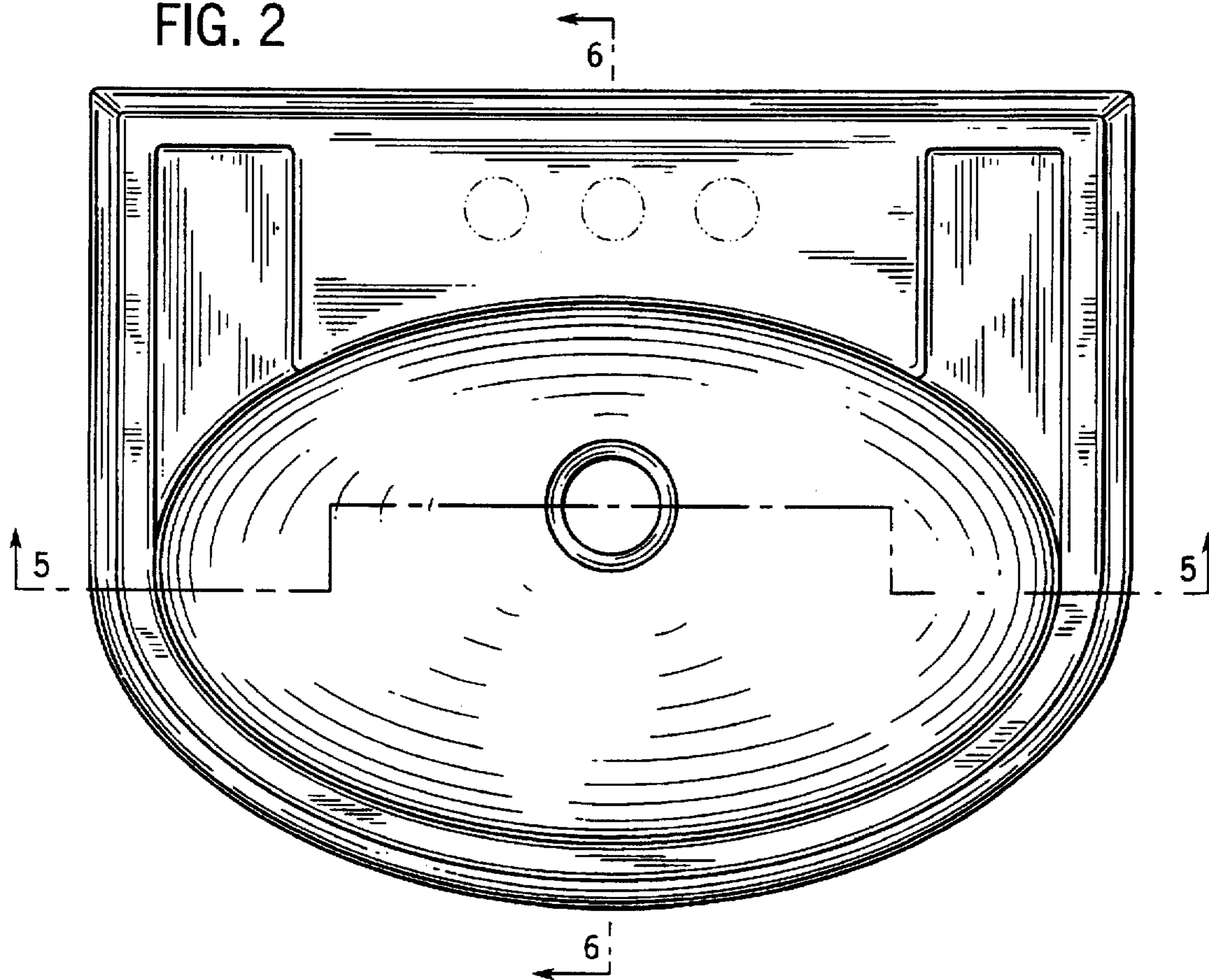

FIG. 2



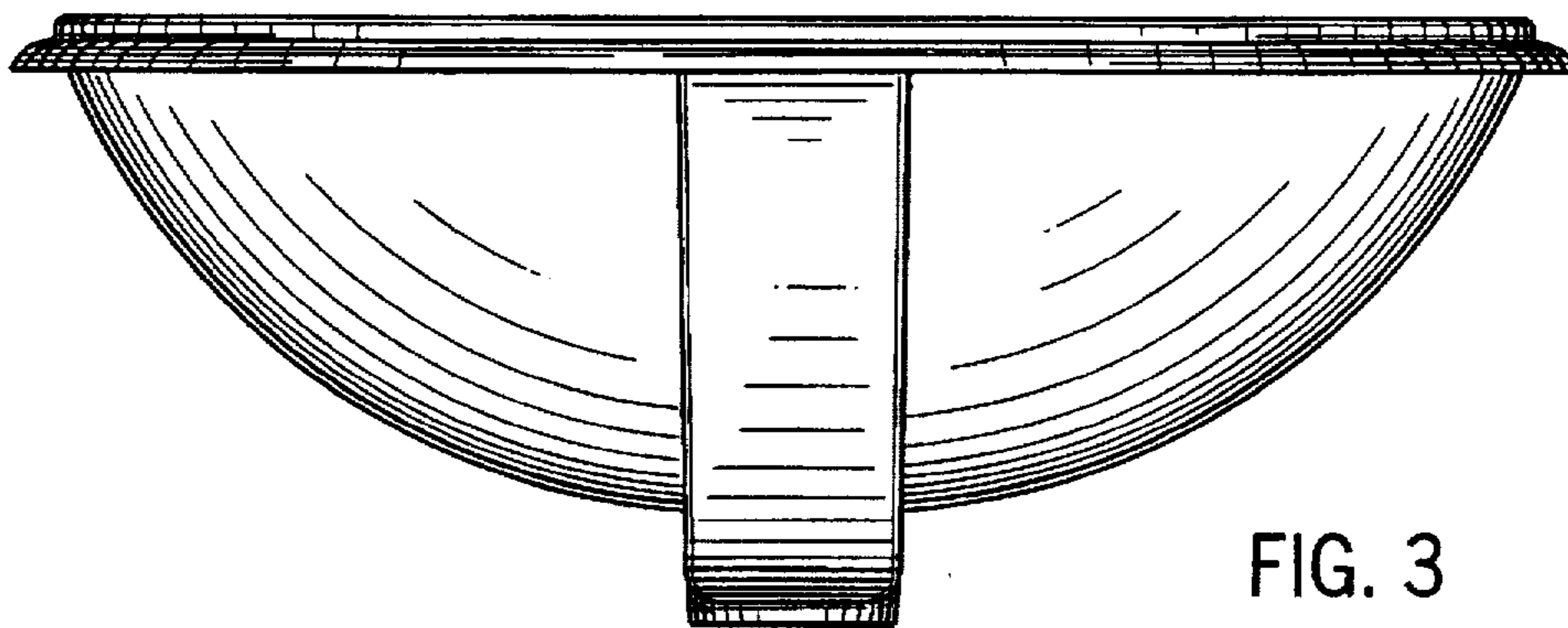

FIG. 3

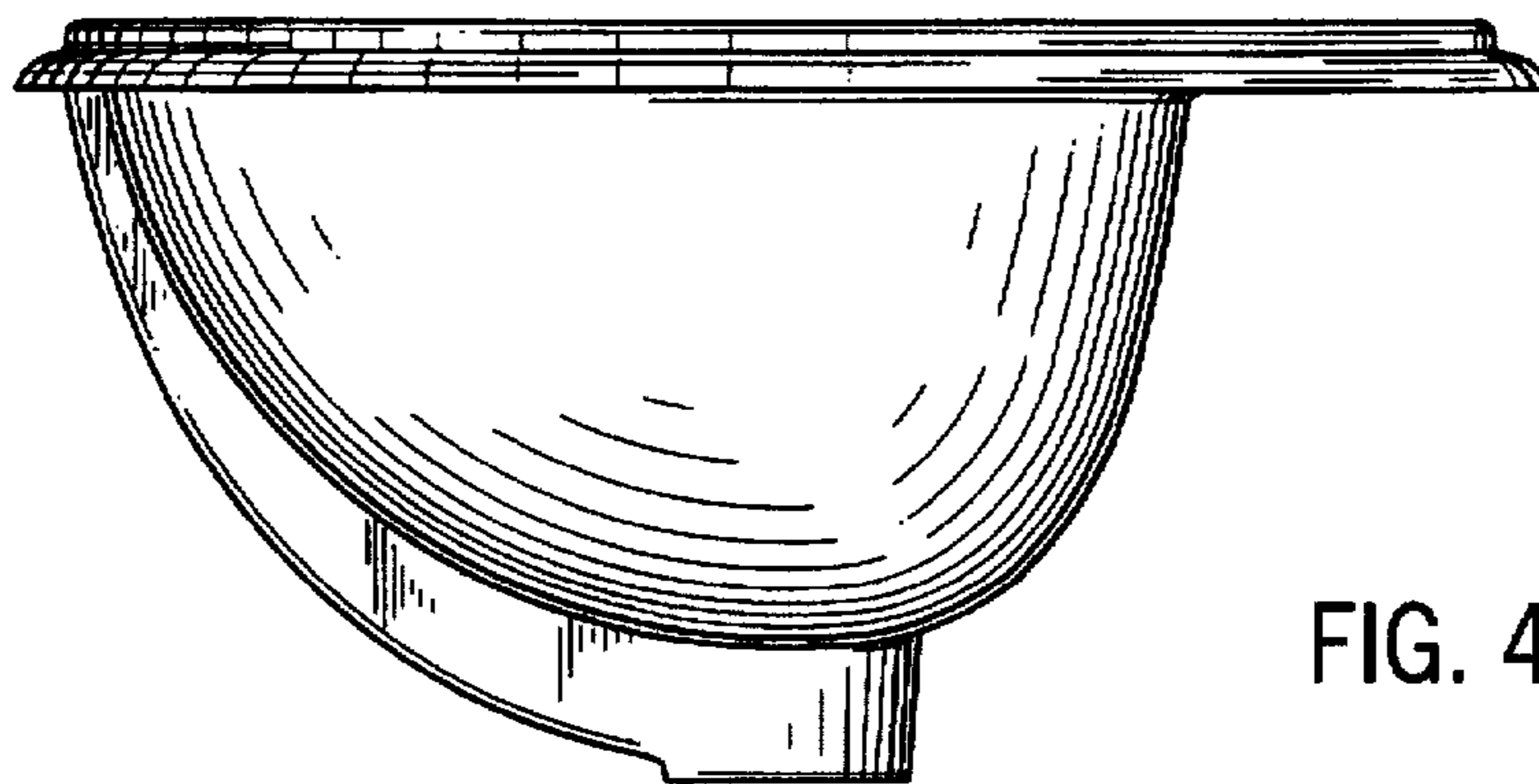

FIG. 4

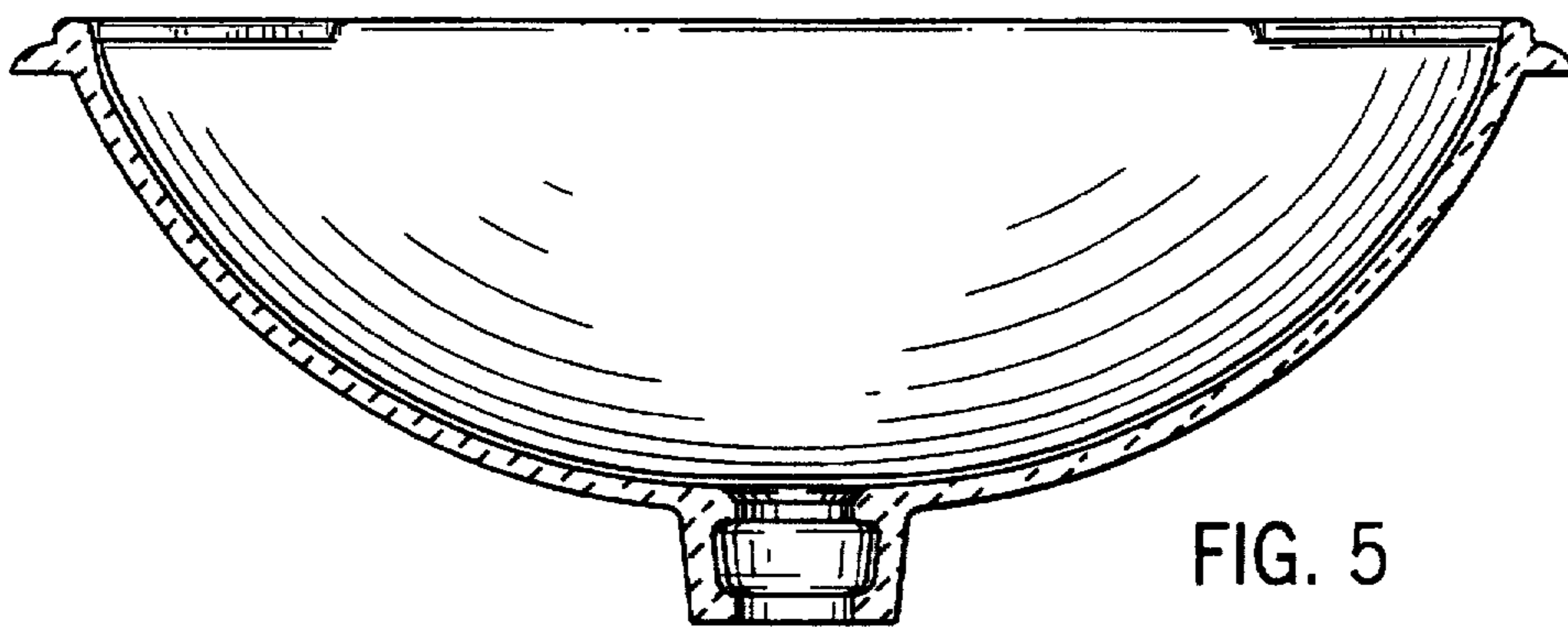

FIG. 5

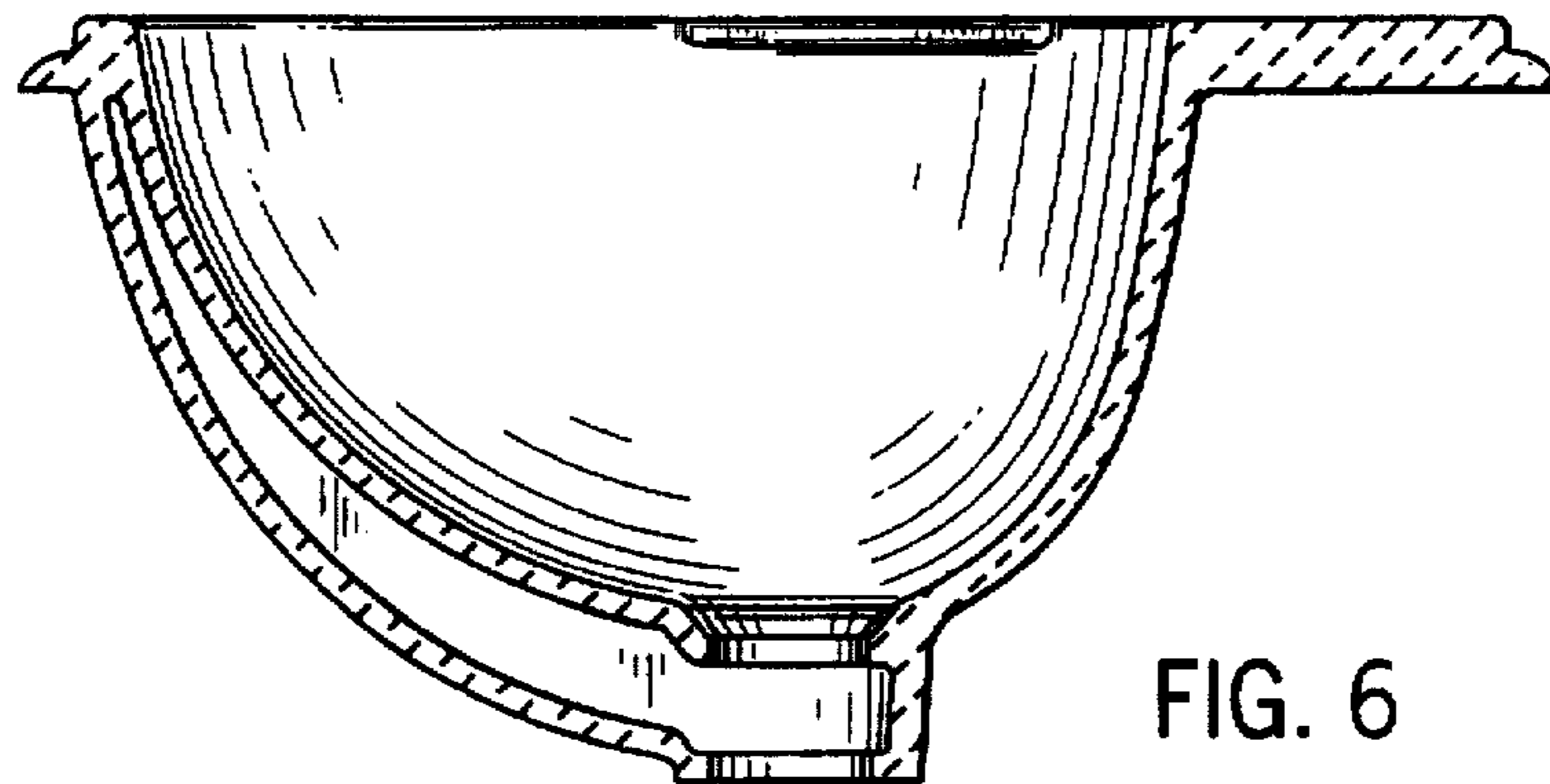

FIG. 6