



US00D390915S

# United States Patent [19]

Futo et al.

[11] Patent Number: **Des. 390,915**

[45] Date of Patent: **\*\*Feb. 17, 1998**

[54] **SINK SPRAYER**

[75] Inventors: **Dennis M. Futo**, Strongsville; **Jesse P. Carlson**; **Erin Q. Riddell**, both of Cleveland, all of Ohio

[73] Assignee: **Waxman Consumer Products Group Inc.**, Bedford Heights, Ohio

[\*\*] Term: **14 Years**

[21] Appl. No.: **63,362**

[22] Filed: **Dec. 6, 1996**

[51] **LOC (6) Cl.** ..... **23-01**

[52] **U.S. Cl.** ..... **D23/226**

[58] **Field of Search** ..... D23/213, 223, D23/226, 229, 230; 239/525-528, 459, 460; 4/605, 615, 675

[56] **References Cited**

**U.S. PATENT DOCUMENTS**

D. 320,643	10/1991	Stansbury	.....	D23/226
D. 337,811	7/1993	Valley et al.	.....	D23/226
D. 373,173	8/1996	Valley et al.	.....	D23/226
D. 378,122	2/1997	Milrud et al.	.....	D23/226

2,616,660	11/1952	Morehouse	.
3,402,892	9/1968	Ayrial	.
5,025,825	6/1991	Gayton	..... 4/675
5,305,476	4/1994	Ohyama	.

*Primary Examiner*—Alan P. Douglas  
*Assistant Examiner*—Robin V. Taylor  
*Attorney, Agent, or Firm*—Vickers Daniels & Young

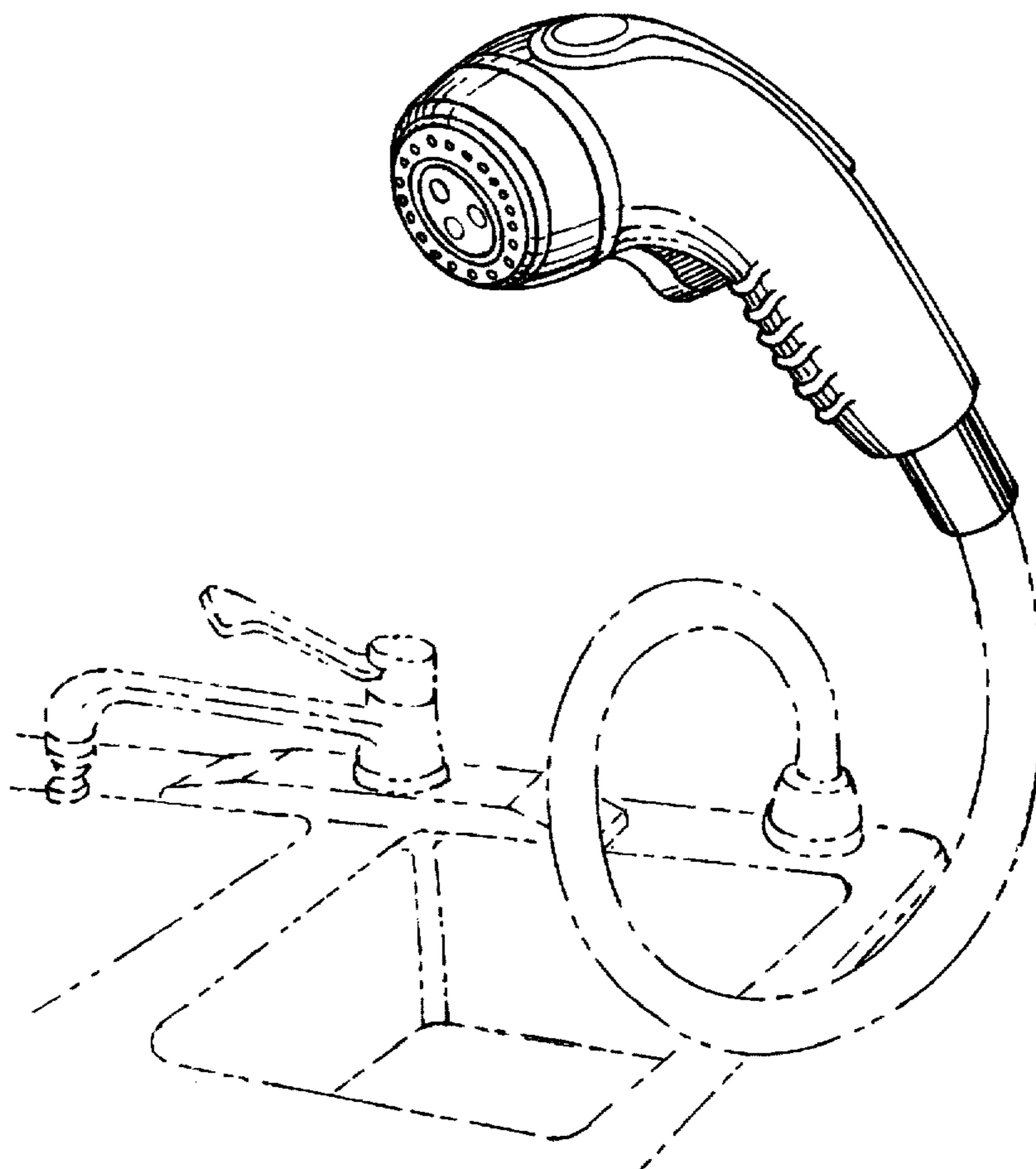
[57] **CLAIM**

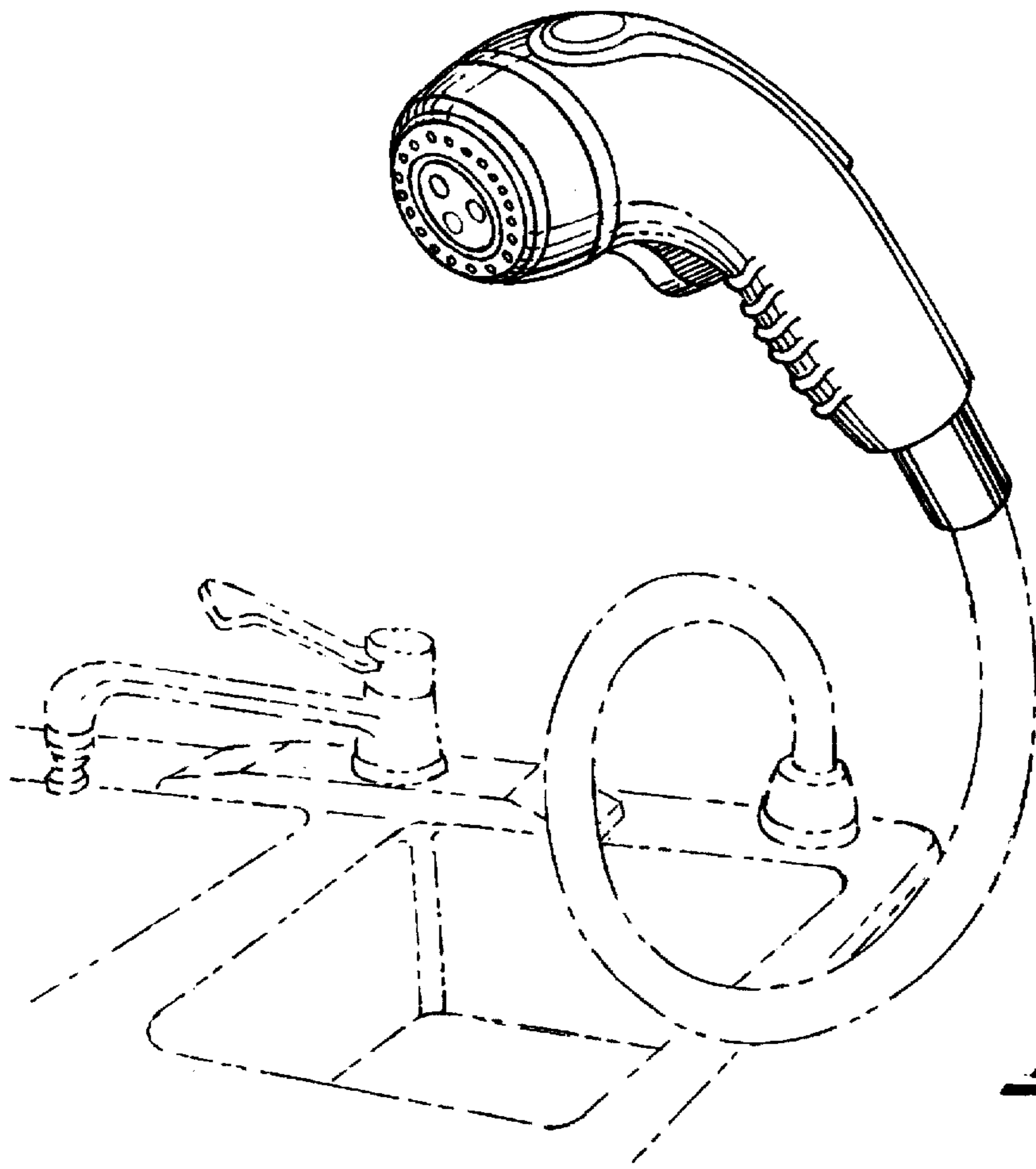
The ornamental design for a sink sprayer, as shown and described.

**DESCRIPTION**

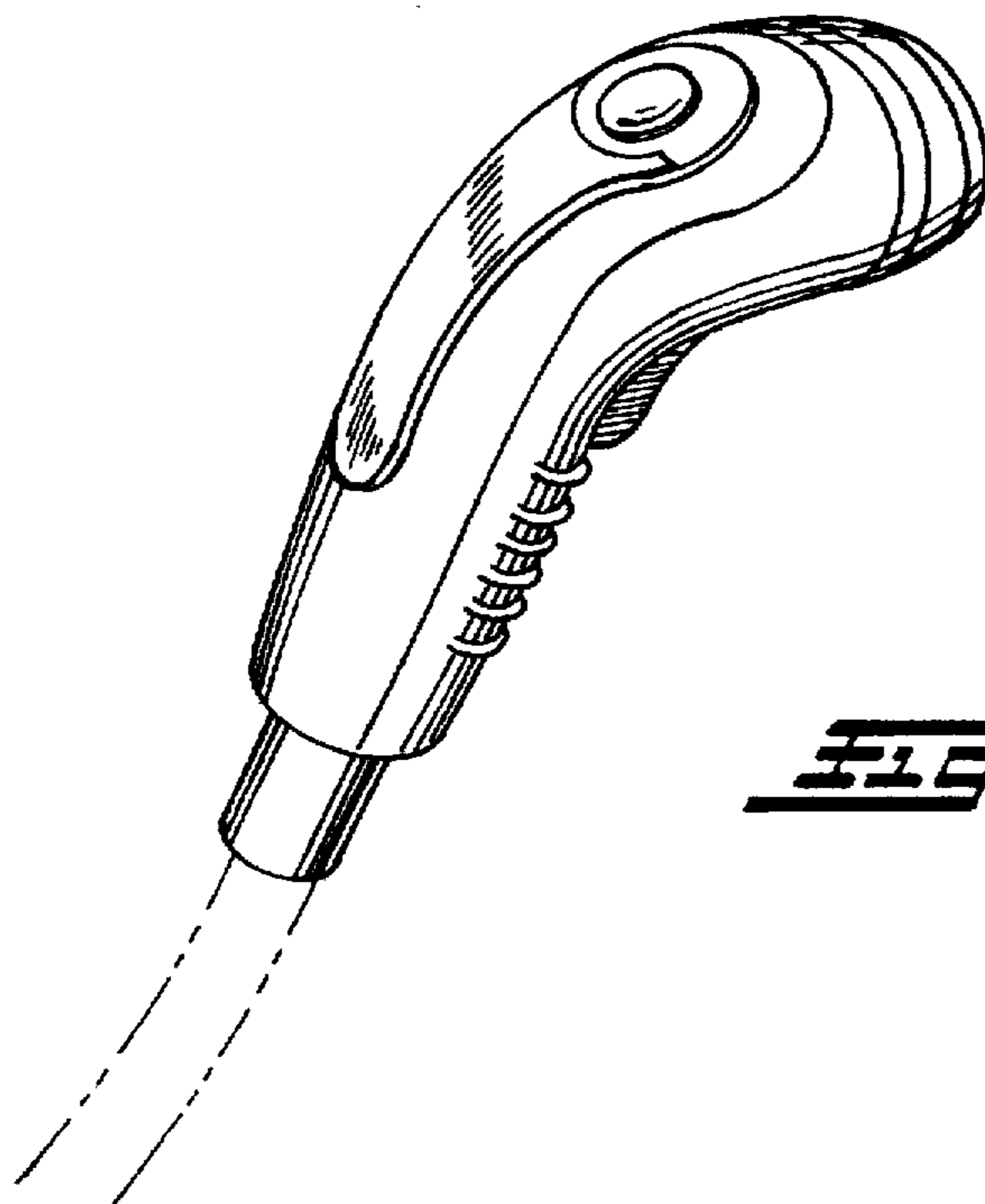
FIG. 1 is a front perspective view of a sink sprayer showing our new design;  
FIG. 2 is a rear perspective view thereof;  
FIG. 3 is a front elevational view thereof;  
FIG. 4 is a rear elevational view thereof;  
FIG. 5 is a right side elevational view thereof, the left side elevation being identical;  
FIG. 6 is a top plan view thereof; and,  
FIG. 7 is a bottom plan view.  
The broken line showing is for illustrative purposes only and forms no part of the claimed design.

**1 Claim, 2 Drawing Sheets**

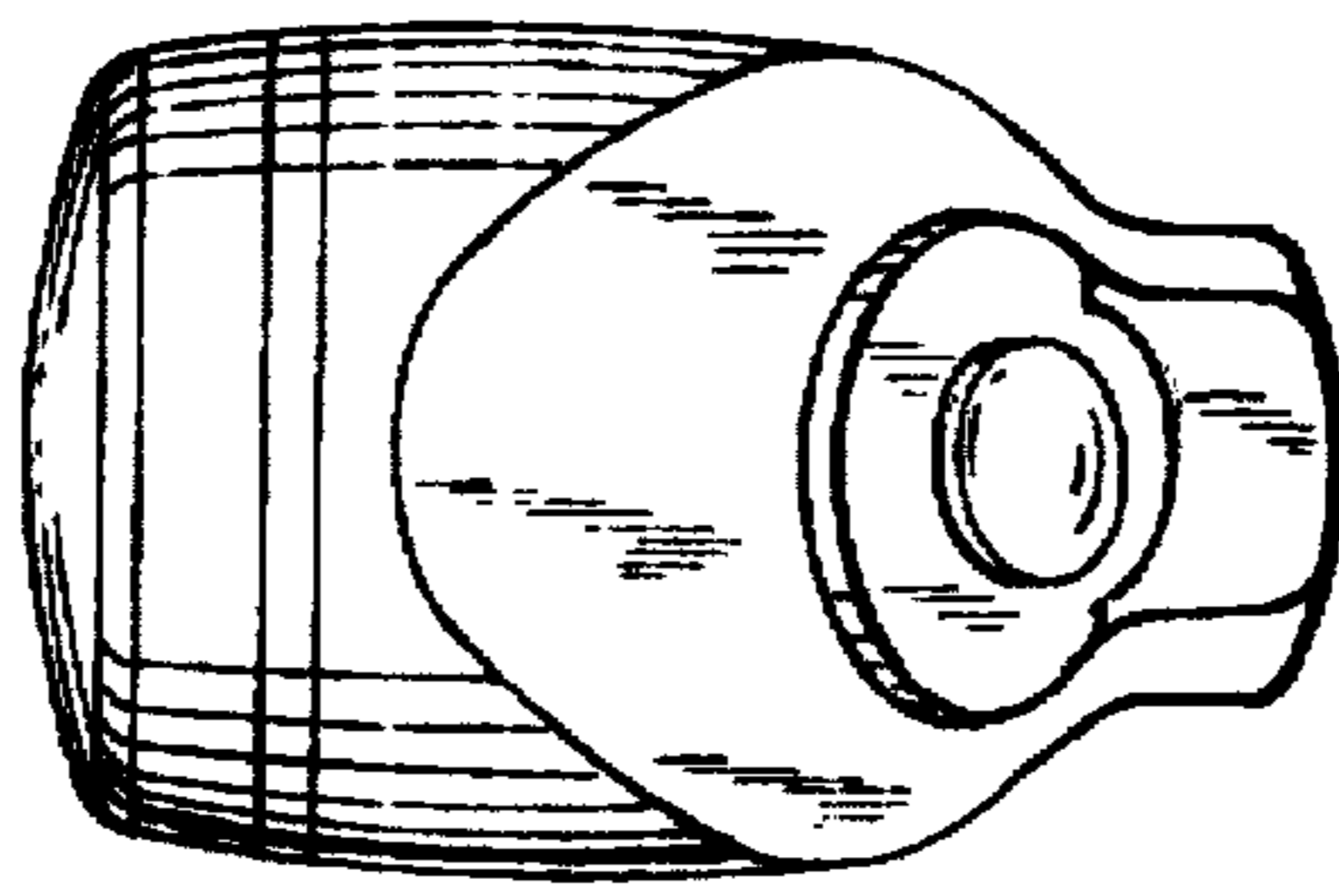




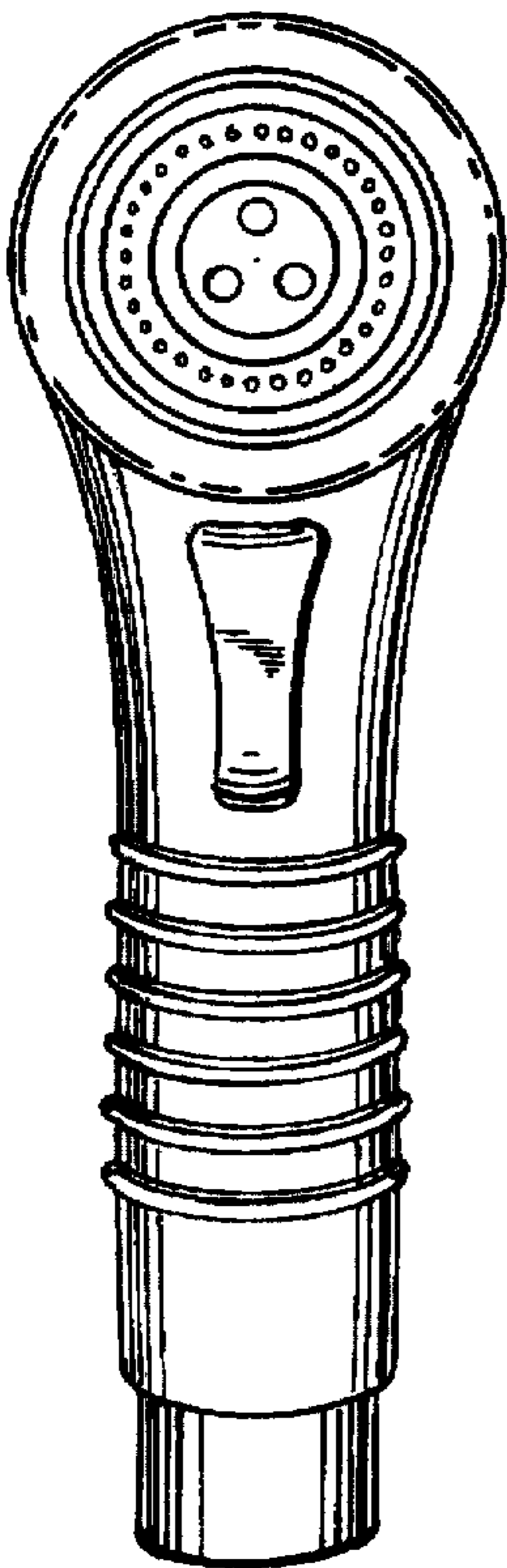
**FIG. 1**



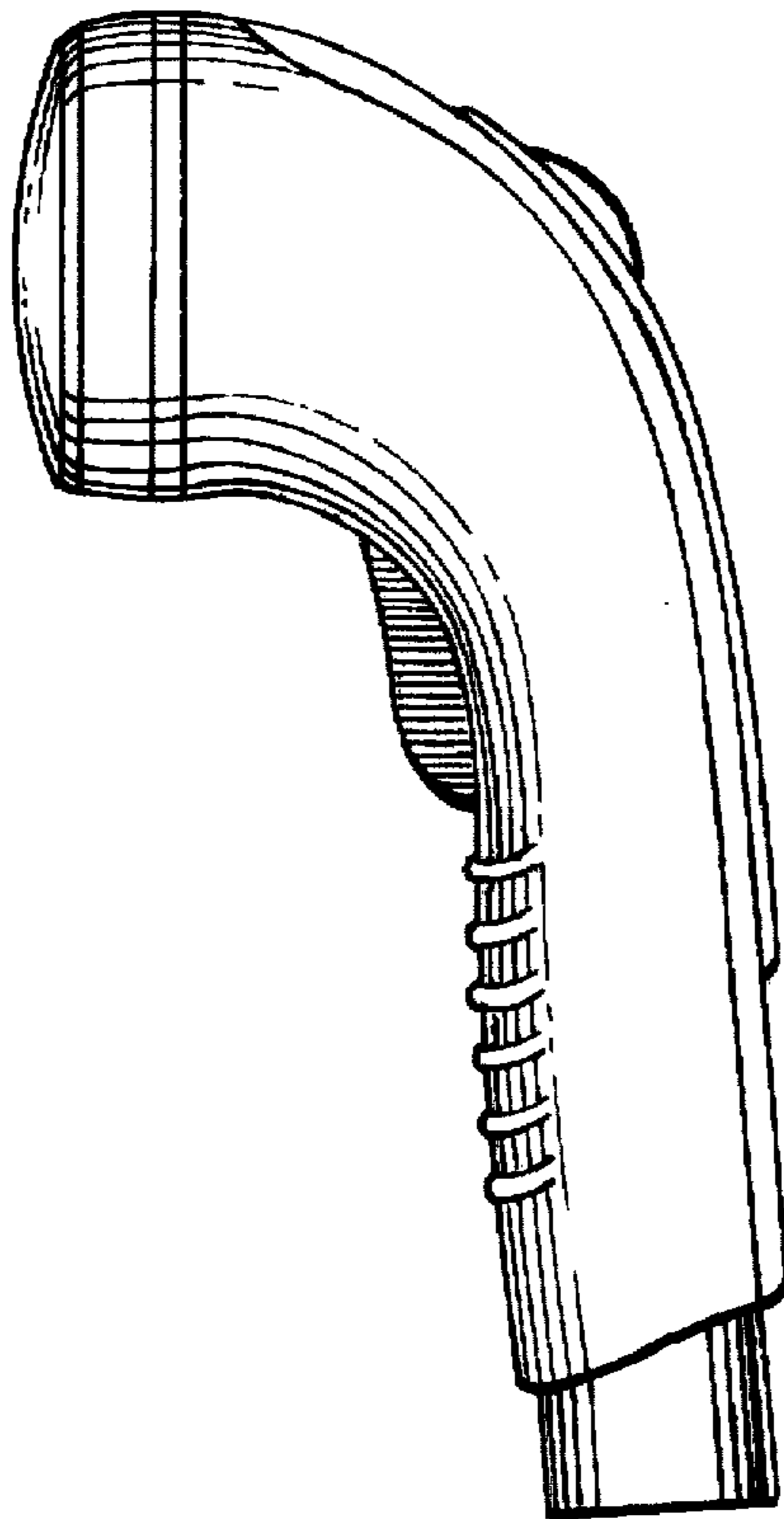
**FIG. 2**



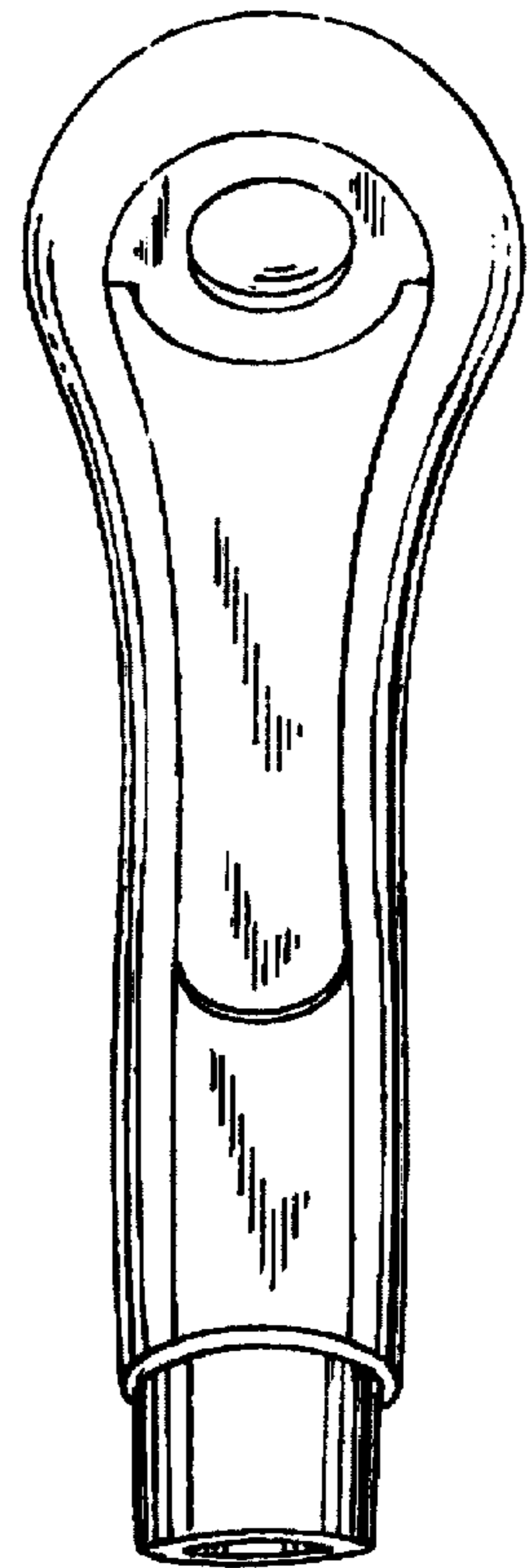
**FIG. 6**



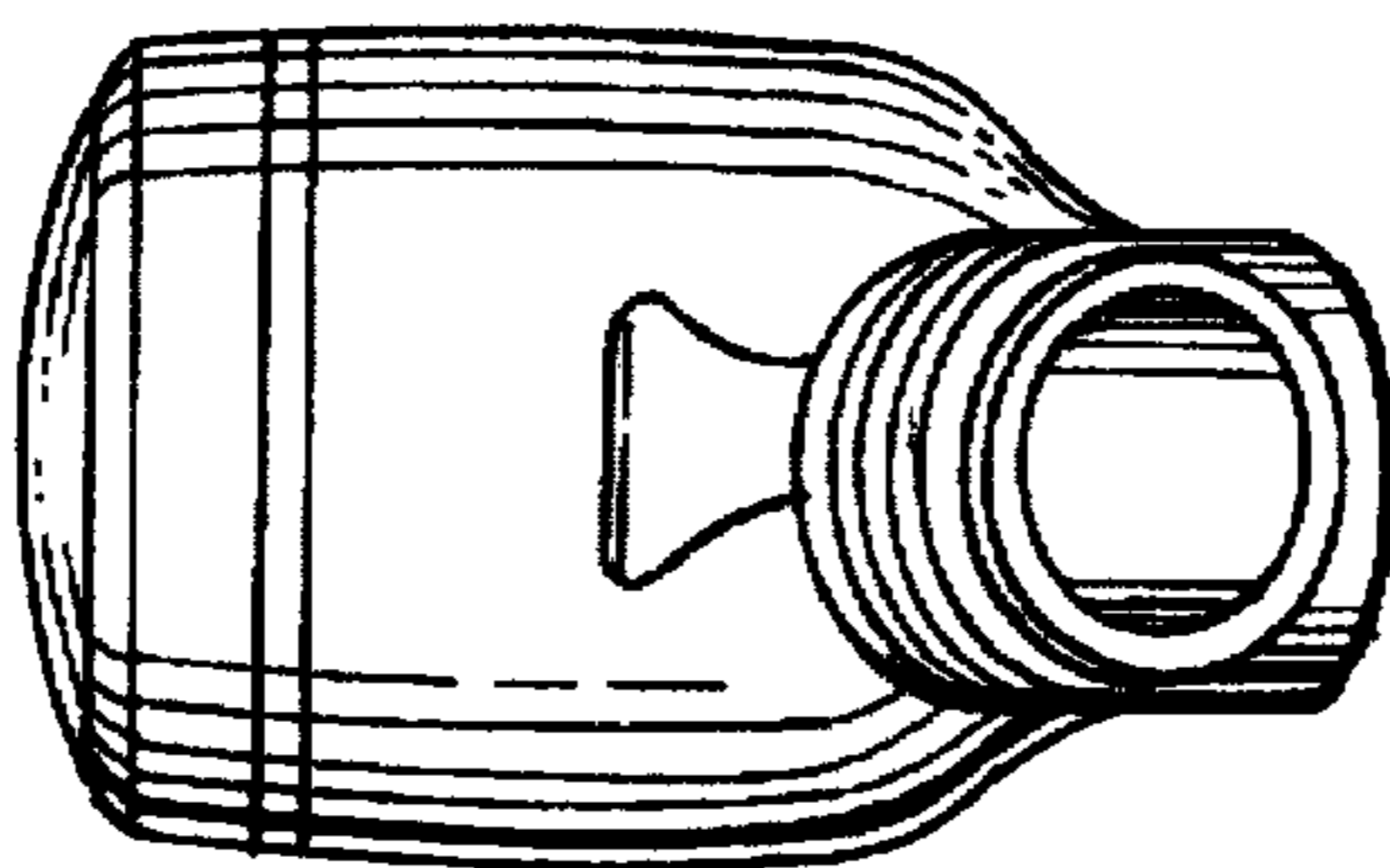
**FIG. 3**



**FIG. 5**



**FIG. 4**



**FIG. 7**